

16.810 (16.682)

Engineering Design and Rapid Prototyping

Lecture 6



Manufacturing - CAM

Instructor(s)

Prof. Olivier de Weck
deweck@mit.edu

Dr. Il Yong Kim
kiy@mit.edu

January 14, 2004

16.810 Outline

- Introduction to Manufacturing
 - Parts Fabrication and Assembly
 - Metrics: Quality, Rate, Cost, Flexibility
 - Water Jet Cutting
- Video Sequence B777 Manufacturing
 - Role of Manufacturing in a Real World Context
- OMax Introduction
 - Computer Aided (Assisted) Manufacturing
 - Converting a drawing to CNC Routing Instructions

Course Flow Diagram

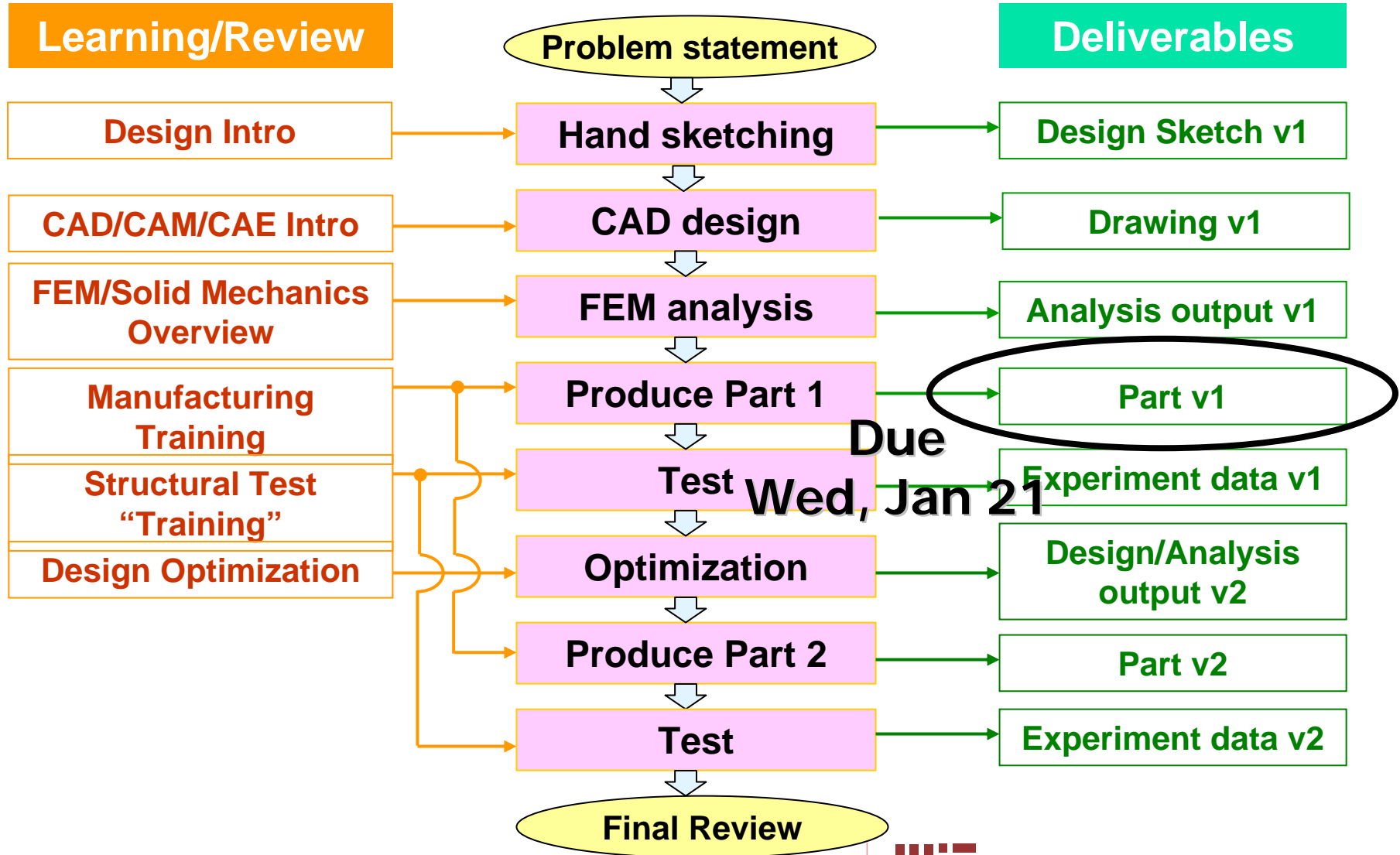

16.810 Introduction to Manufacturing

- Manufacturing is the *physical realization* of the previously designed parts
- Metrics to assess the “performance” of mfg
 - Quality
 - does it meet specifications?
 - Rate
 - how many units can we produce per unit time?
 - Cost
 - What is the cost per unit?
 - What is the investment cost in machinery & tooling?
 - Flexibility
 - what else can be make with our equipment?
 - How long does it take to reconfigure the plant?

Life Cycle: Conceive, Design, Implement

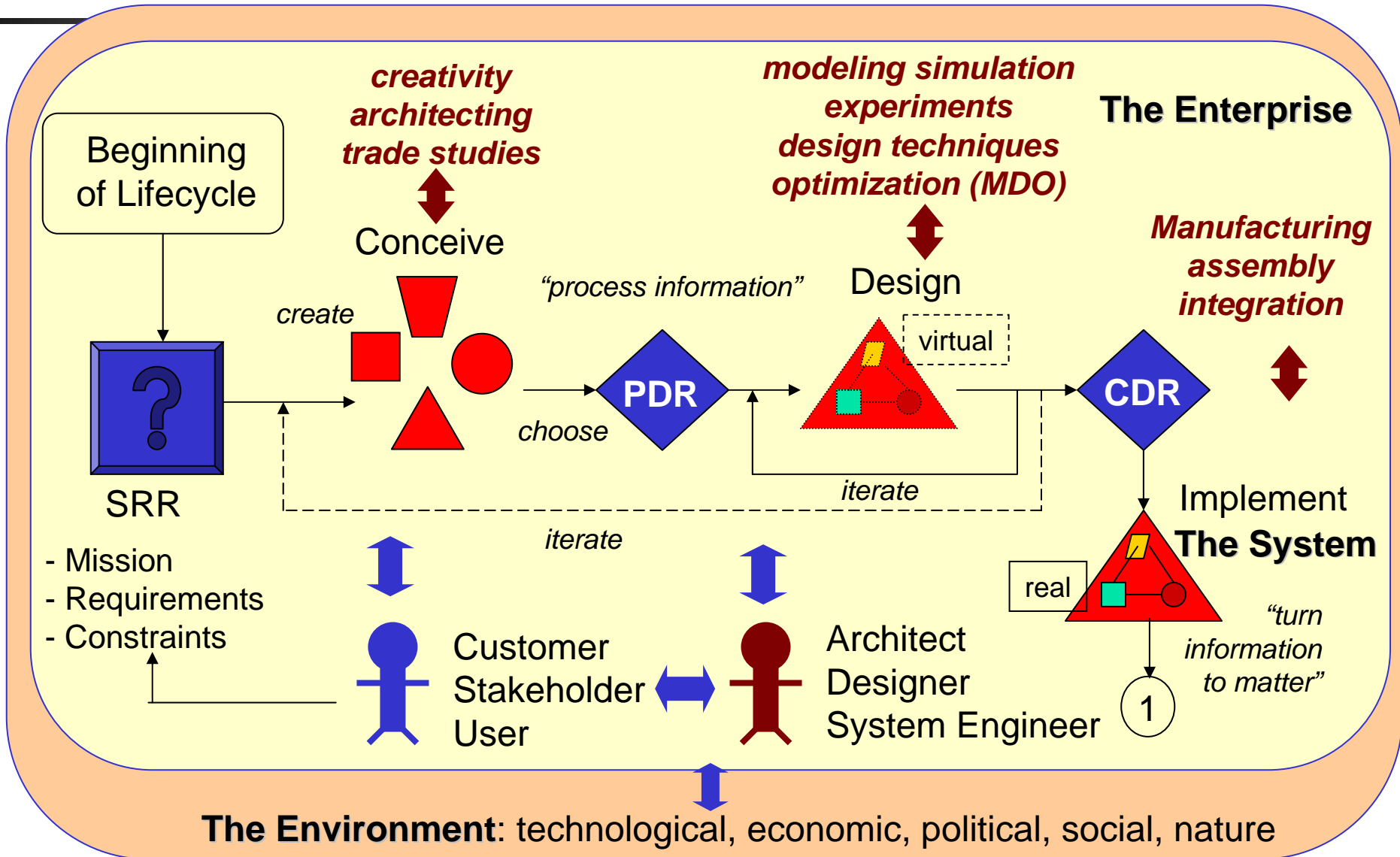

Simple Manufacturing Plant

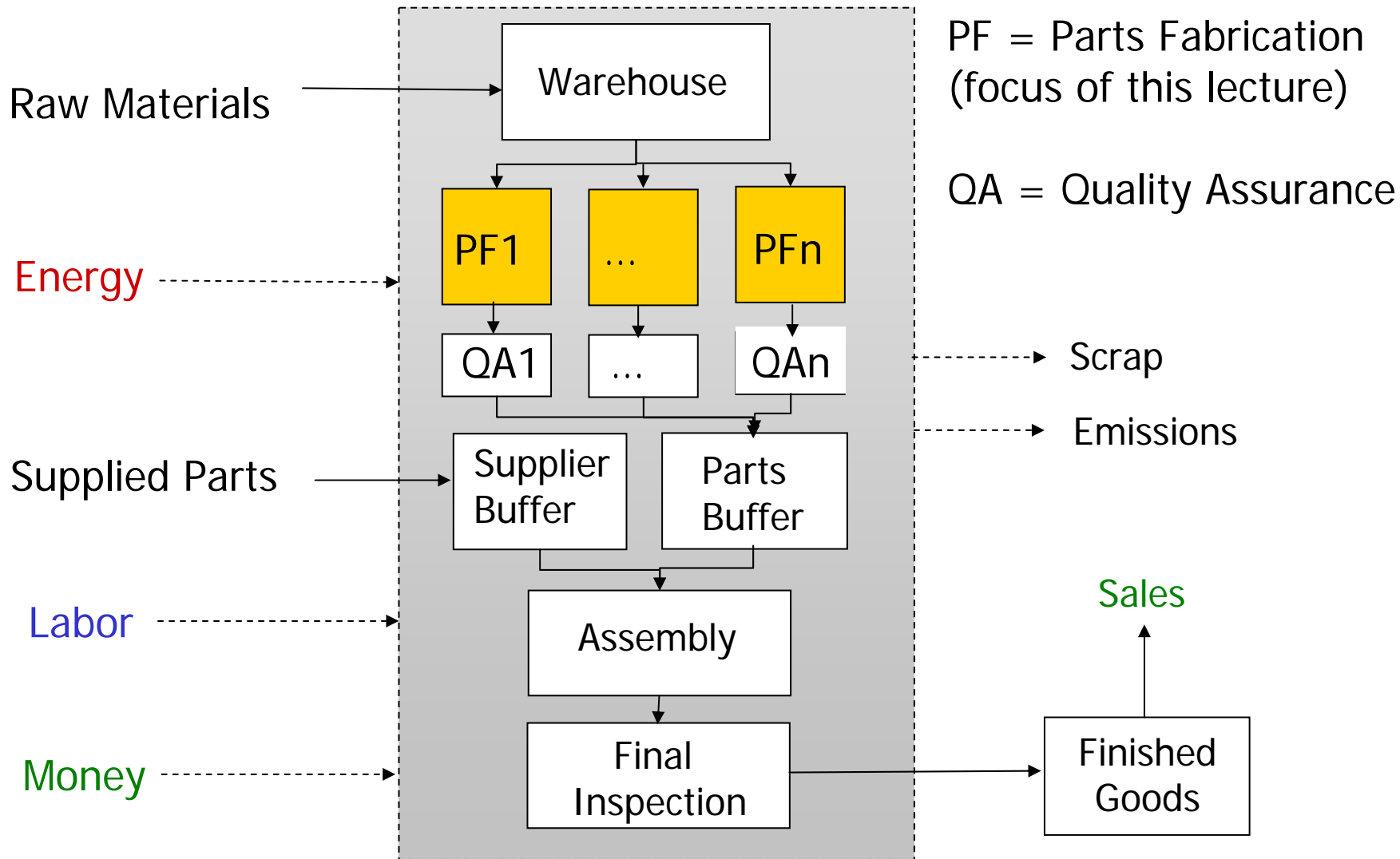

16.810 Raw Materials

Ashby Diagram

- Material Selection
 - Strength
 - Density
 - Cost
 - ...
- Form
 - Sheet
 - Rods, ...

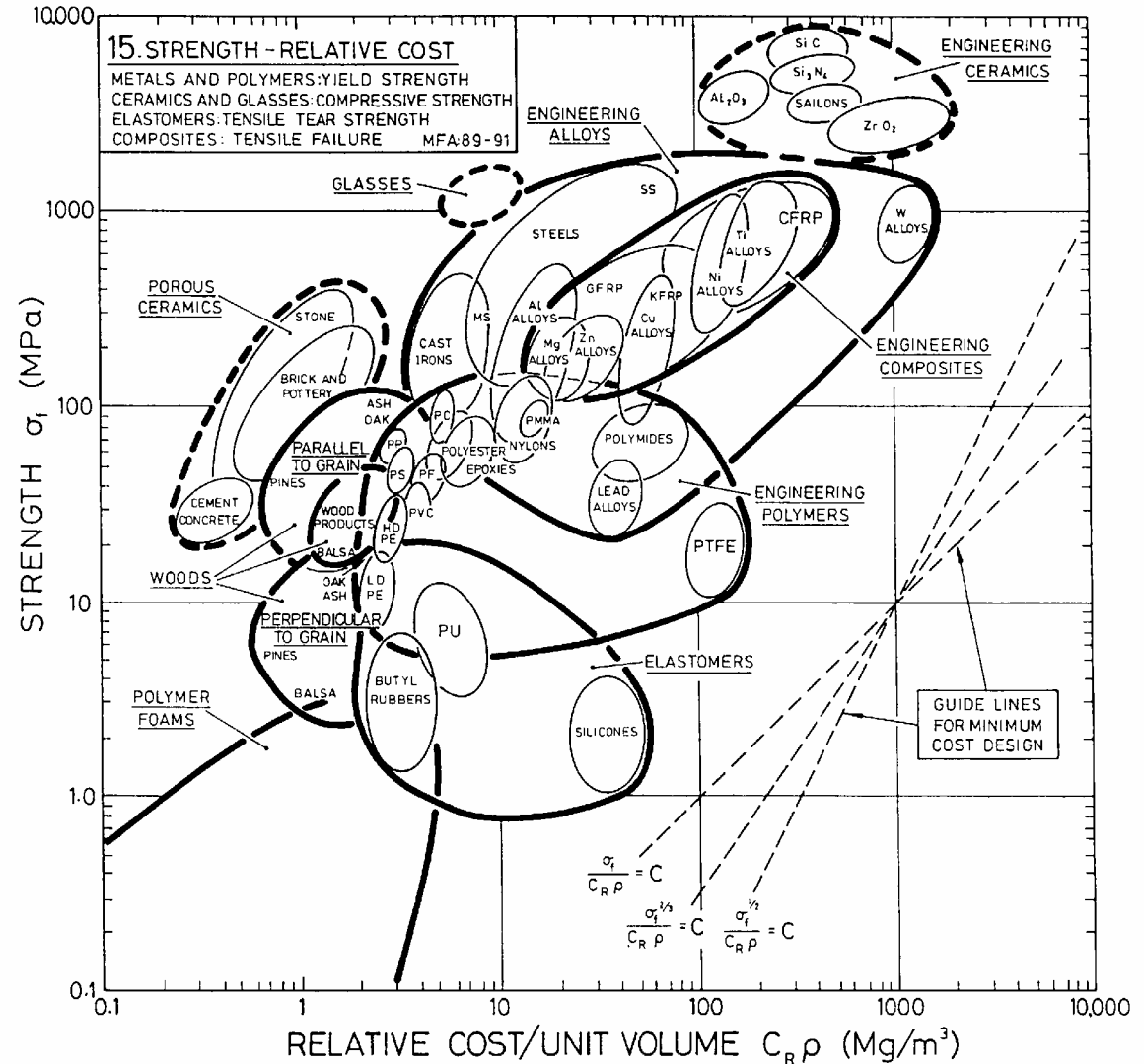

- example: deck components
 - Ribbed-bulkheads
 - Approximate dimensions
 - 250mm x 350mm x 30mm
 - Wall thickness = 2.54mm

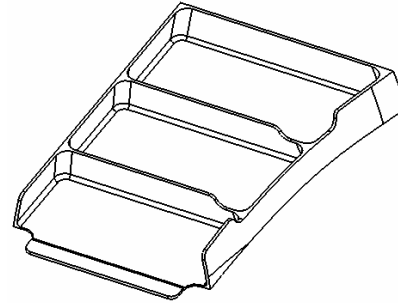

decks

- Fundamental Parts Fabrication Techniques
 - Machining – e.g. milling, laser and waterjet cutting ...
 - Forming – e.g. deep drawing, forging, stamping
 - Casting - fill die with liquid material, let cool
 - Injection Molding - mainly polymers
 - Layup – e.g. Pre-preg composite manufacturing
 - Sintering - form parts starting from metal powder

16.810 Metal Cutting/Removal Techniques

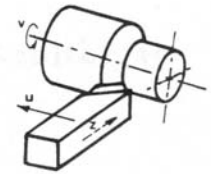

a) Drehen
Turning on a lathe

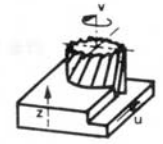

b) Fräsen
Milling

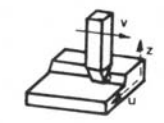

c) Hobeln
Planing

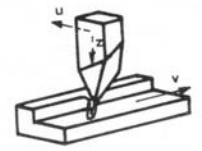

d) Stossen
Slotting

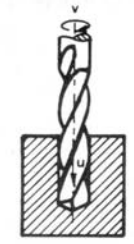

e) Bohren
Drilling

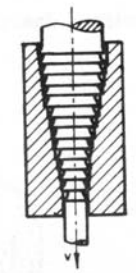

f) Räumen
Reaming



h) Senken
Countersinking

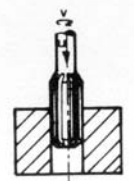

h) Reiben
Reaming

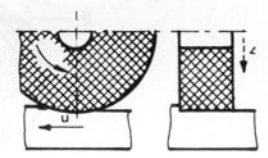

i) Schleifen
Grinding

New Techniques:

Laser Cutting
(mainly for sheet metal)

Waterjet Cutting

- Tolerance --The total amount by which a specified dimension is *permitted to vary* (ANSI Y14.5M)
- Every component within spec adds to the yield (Y)

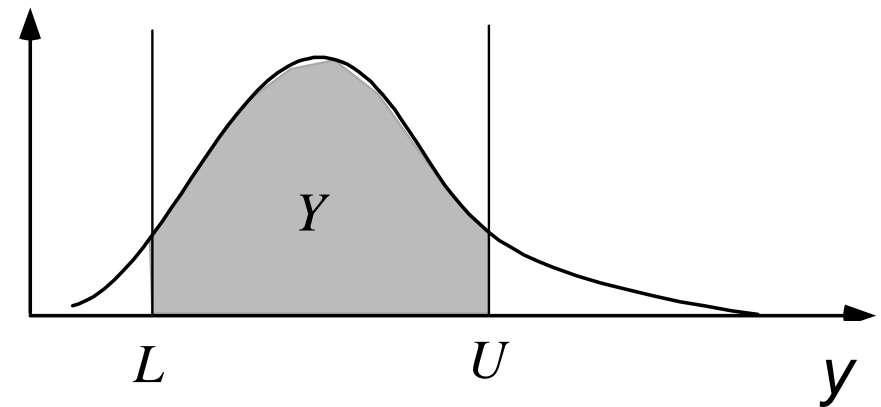

16.810 Process Capability Indices

- Process Capability Index $C_p \equiv \frac{(U - L)/2}{3\sigma}$
- Bias factor $k \equiv \frac{\left| \mu - \frac{U + L}{2} \right|}{(U - L)/2}$
- Performance Index $C_{pk} \equiv C_p(1 - k)$

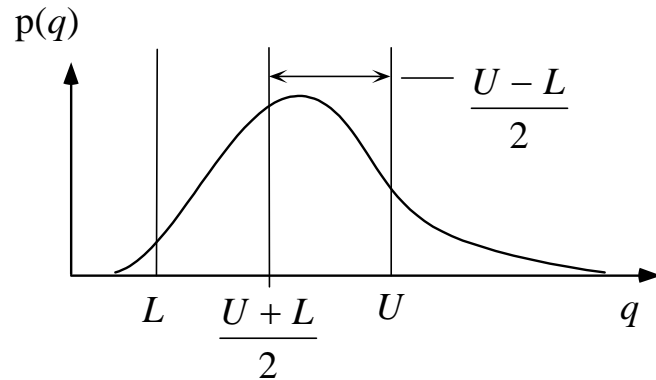

16.810 Rate: Manufacturing

- Typically: #of units/hour
- The more parts we make (of the same kind), the lower the cost/unit
 - Learning Curve effects
 - Higher Speed - Human learning
 - Reduced setup time
 - Fewer Mistakes (= less scarp=higher yield)
 - Bulk quantity discounts (=economies of scale)
 - Better negotiating position with suppliers of raw materials and parts

Learning Curve Equation

- Credited to T.P. Wright [1936]
- Model cost reduction between first production unit and subsequent units
 - Model the total production cost of N units

TFU = Theoretical first unit cost

S = learning curve slope in %

--> percentage reduction in cumulative average cost, each time the number of production units is doubled

Recommended:

$2 < N < 10$ $S = 95\%$

$10 < N < 50$ $S = 90\%$

$N > 50$ $S = 85\%$

$$C_{total}(N) = TFU \cdot N^B$$

$$B \equiv 1 - \frac{\ln(100\%/S)}{\ln 2}$$

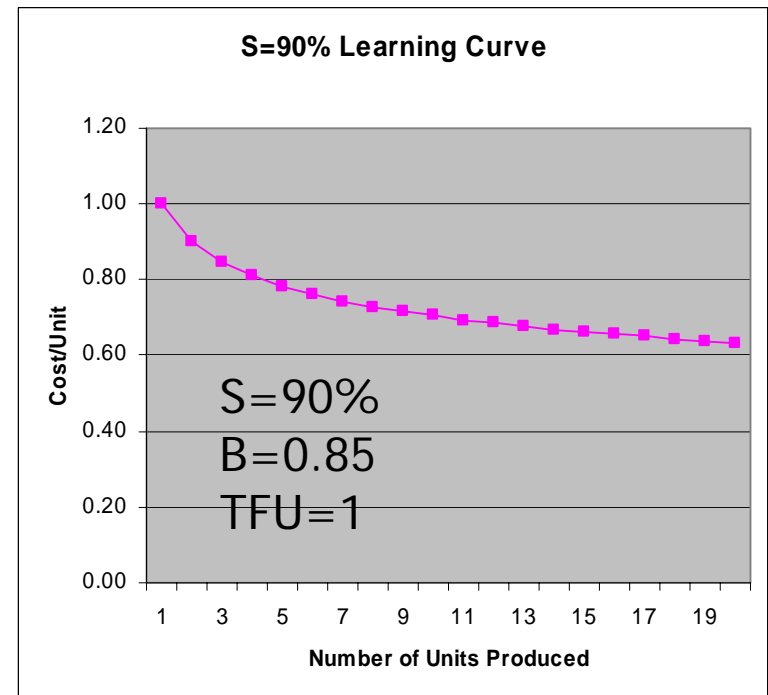

16.810 Cost: Driving Factors

- Cost/Unit [\$]
 - Depends on
 - Manufacturing process chosen
 - Number of Parts made
 - Skill and Experience of worker(s), Salary
 - Quality of Raw Materials
 - Reliability of Equipment
 - Energy Costs
 - Land/Facility Cost
 - Tolerance Level (Quality)

Process Selection

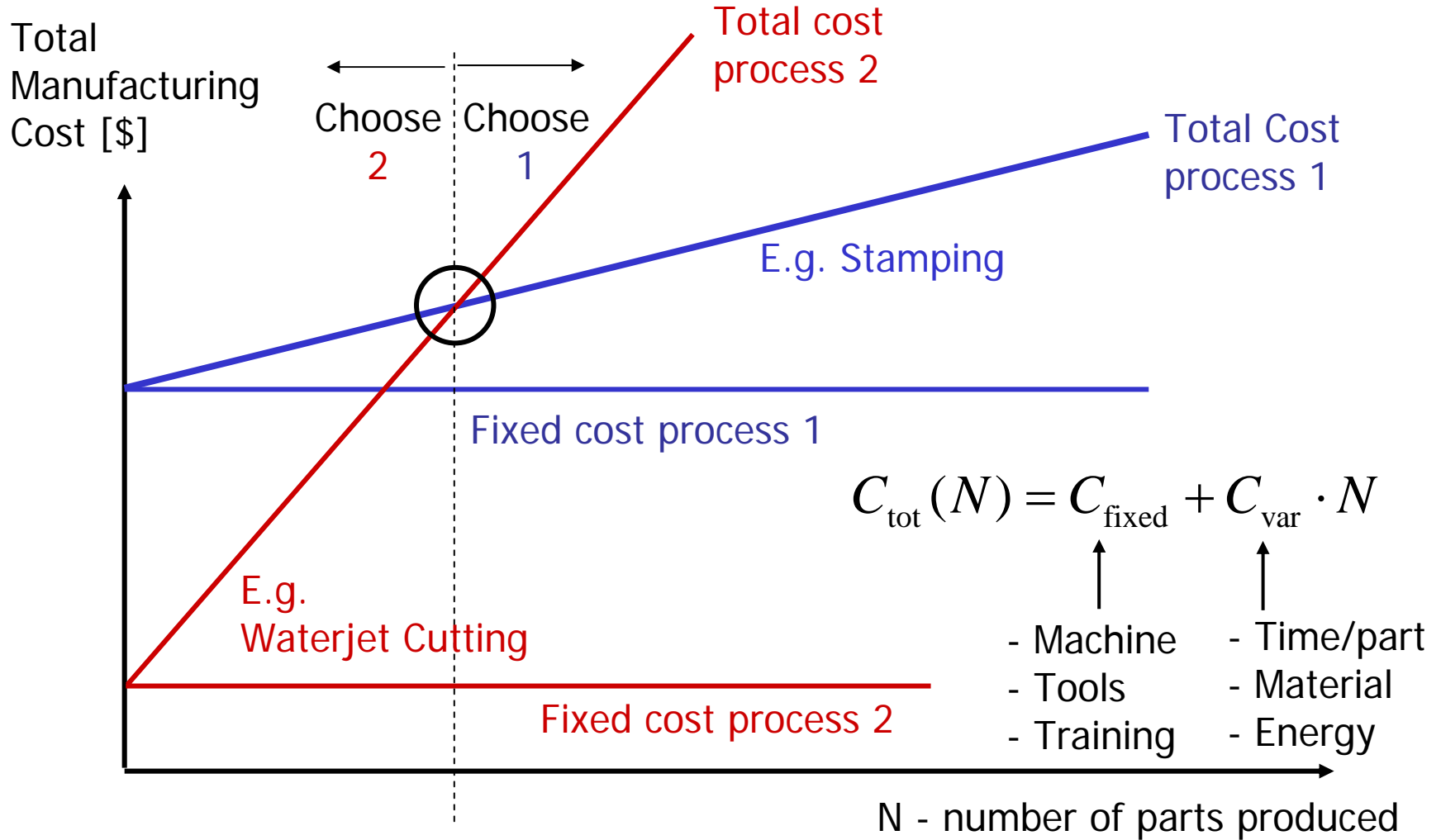

16.810 Flexibility: Uncertainties

- Short market cycles
- Distinct customers with changing needs
- Changes in laws, regulations & standards
- ↪ Uncertainties in products and, therefore, in single parts!
- How to address these uncertainties?
- ↪ Flexibility as 'Magic bullet'?

- Flexibility is the ease with which a system can change from one state to another!
- Which process is more flexible than others?

What type
of flexibility?

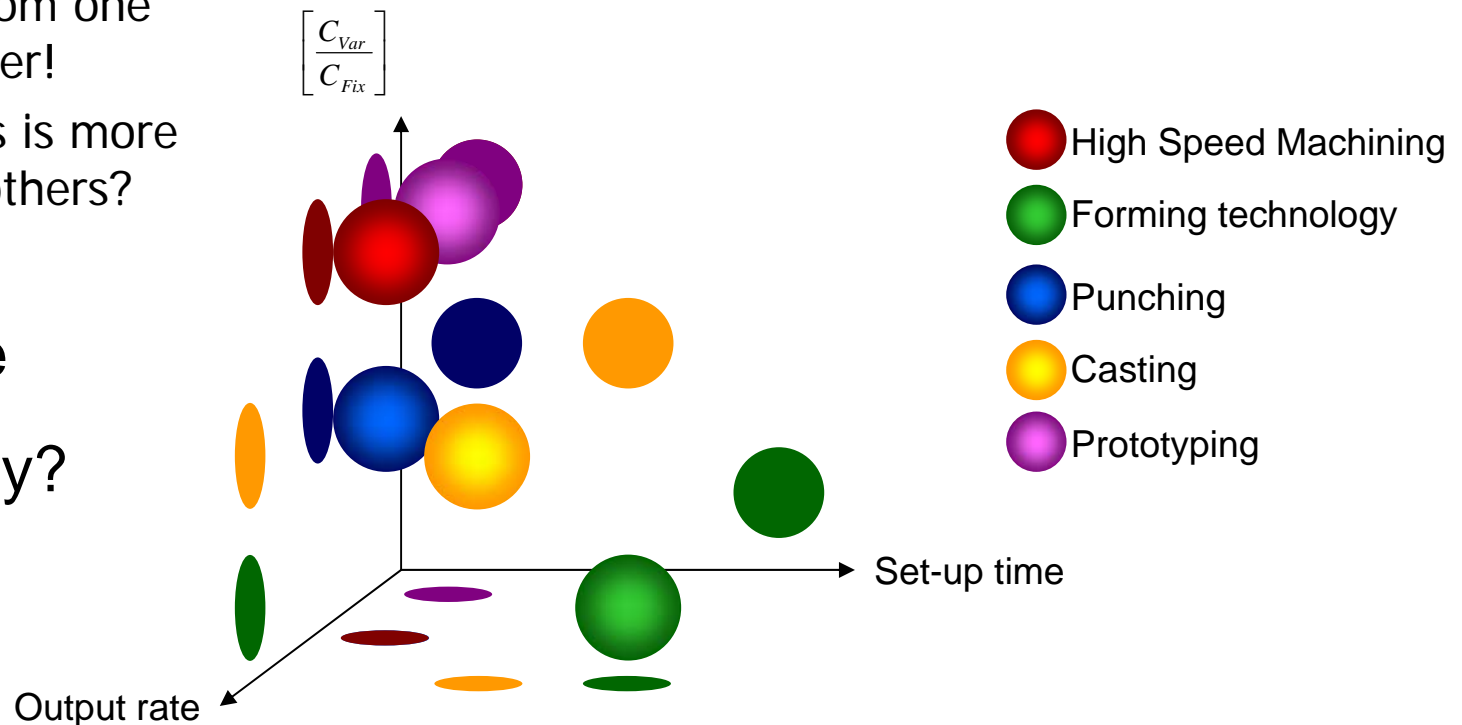

Types of Flexibilities and their Linkage

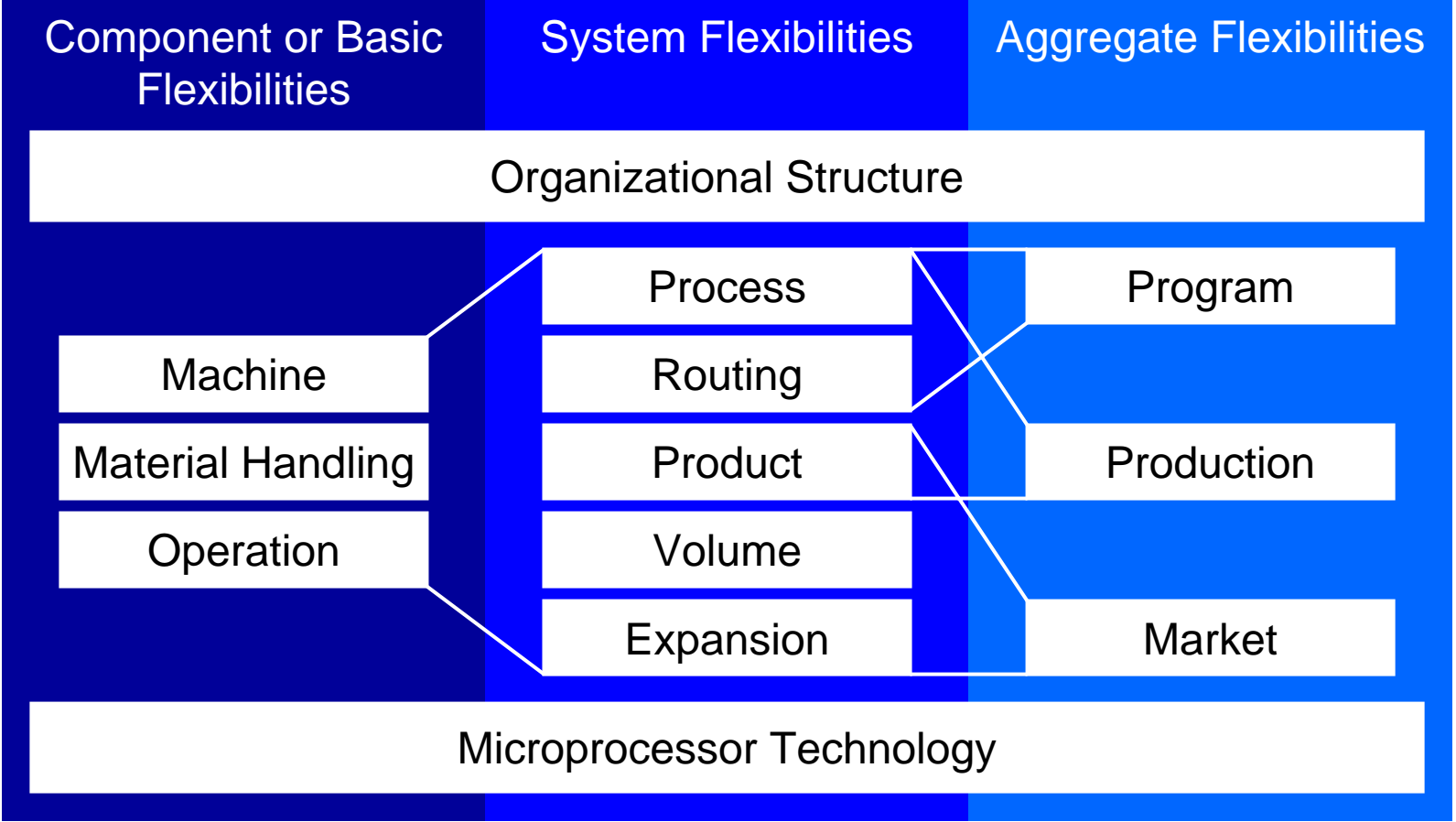

- **Industrial uses of ultra-high pressure waterjets began in the early 1970s.**
Pressures: 40,000 ~ 60,000 psi
Nozzle diameter: 0.005"
- **Special production line machines were developed to solve manufacturing problems related to materials that had been previously been cut with knives or mechanical cutters.**
- **Examples of early applications**
 - Cardboard**
 - Shapes from foam rubber**
 - Soft gasket material**

- In the early 1990s, John Olsen (pioneer of the waterjet cutting industry) explored the concept of abrasive jet cutting.
- The new system equipped with a computerized control system that eliminated the need for operator expertise and trial-and-error programming.
- Olsen teamed up with Alex Slocum (MIT)
Used cutting test results and a theoretical cutting model by Rhode Island University. Developed a unique abrasive waterjet cutter.

Intensifier Pump

- Early ultra-high pressure cutting systems used hydraulic intensifier pumps.
- At that time, the intensifier pump was the only pump for high pressure
- Engine or electric motor drives the pump

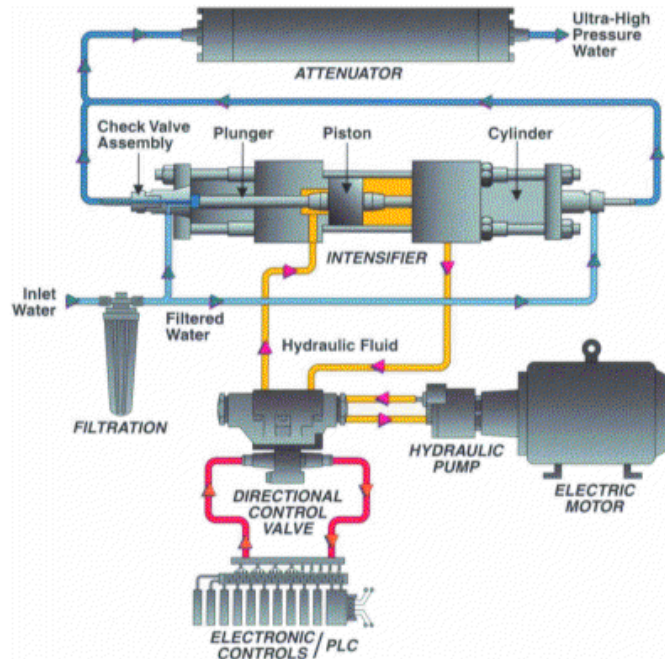

Pressure: ~ 60,000 psi

Crankshaft pumps

- Use mechanical crankshaft to move any number of individual pistons
- Check valves in each cylinder allow water to enter the cylinder as the plunger retracts and then exit the cylinder into the outlet manifold as the plunger advances into the cylinder.

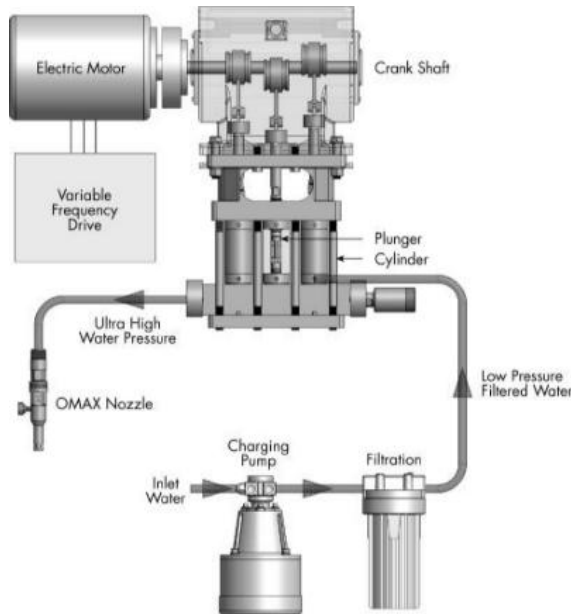

Pressure: ~ 55,000 psi

Reliability is higher.

Actual operating range of most systems : 40,000 ~50,000 psi

An increasing number of abrasivejet systems are being sold with the more efficient and easily maintained crankshaft-type pumps.

Two-stage nozzle design

[1] Water passes through a small-diameter jewel orifice to form a narrow jet. Then passes through a small chamber pulling abrasive material

[2] The abrasive particles and water pass into a long, hollow cylindrical ceramic mixing tube. The resulting mix of abrasive and water exits the mixing tube as a coherent stream and cuts the material.

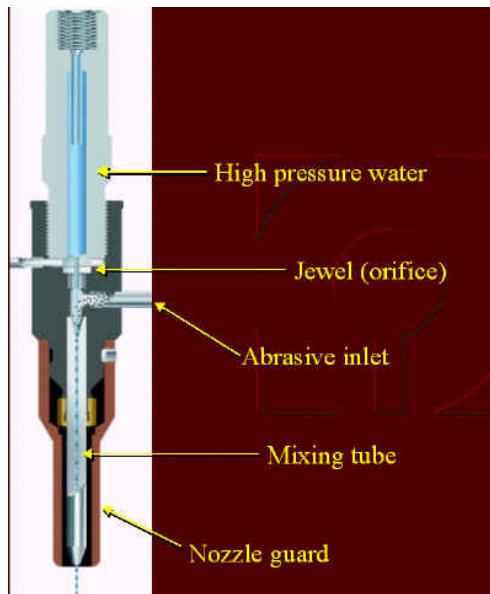

Alignment of the jewel orifice and the mixing tube is critical

In the past, the operator adjusted the alignment often during operation.

Separate

Integrated

Gantry

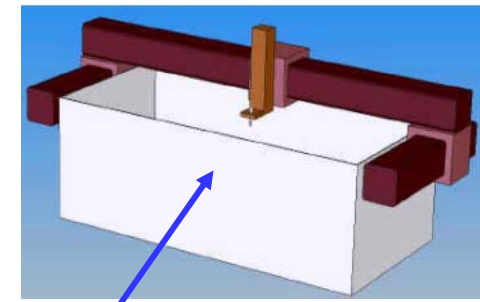
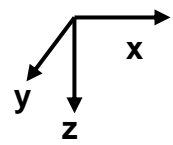
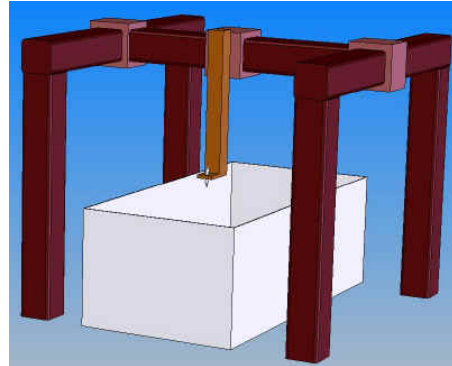

Cutting table

Cantilever

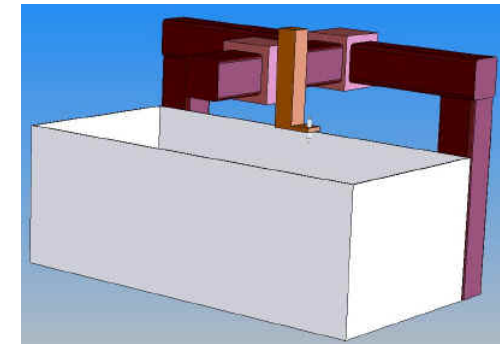
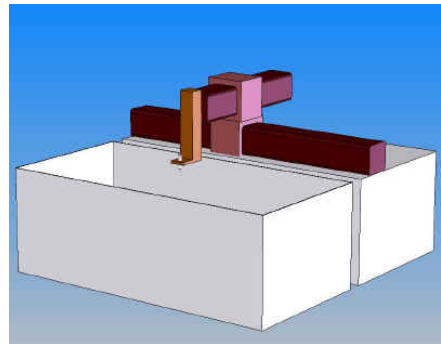

X-Y Tables

Gantry

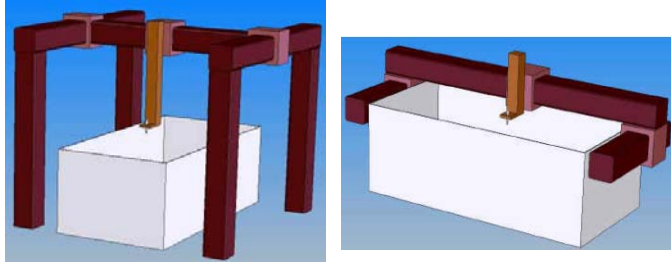

Well-adapted to the use of multiple nozzles for large production runs

Loading material onto the table can be difficult because the gantry beam may interfere, unless the gantry can be moved completely out of the way

Because the gantry beam is moved at both ends, a very high-quality electronic or mechanical system must be employed to

Cantilever

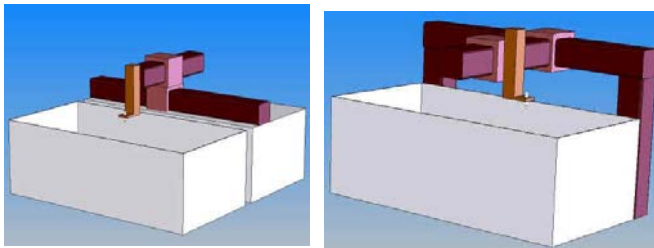

Y-axis is limited in length to about 5 feet because of structural considerations

X-Y Tables

Separate

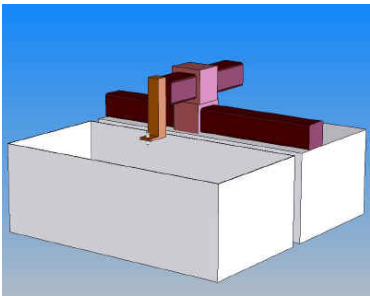
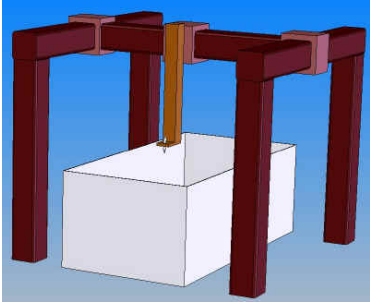

More expensive to build than the traditional separate frame system

Inherently better dynamic accuracy because relative unwanted motion or vibration between the table and X-Y structure is eliminated

System accuracy can be built at the factory and does not require extensive on-site set-up and alignment

Less floor space is required for a given table size because the external support frame is eliminated

Integrated

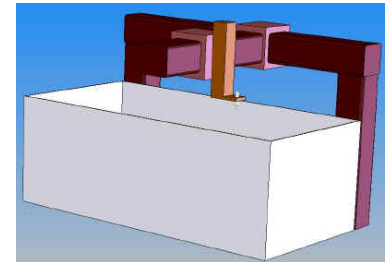
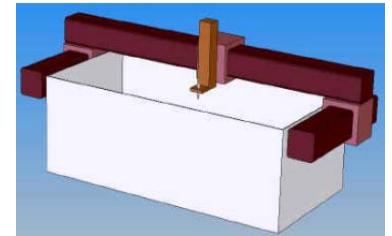

OMAX Machining Center 2652

Integrated
cantilever

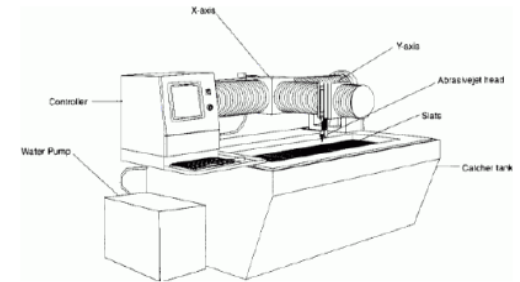
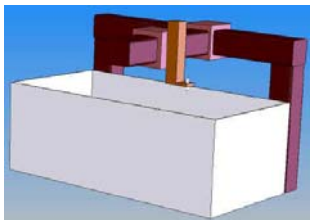

Work Envelope	X-Y Travel *	52" x 26"	(1.3 m x 0.7 m)
	Table size	69" x 30"	(1.8 m x 0.8 m)
Accuracy of Motion at 70 degrees F	Over entire travel	±0.003"	(0.076 mm)
	Over 1 foot travel	±0.002"	(0.051 mm)
	Repeatability	±0.0013"	(0.033 mm)
	Squareness	0.0013" per ft	(0.11 mm/m)
	Straightness	0.0017" per ft	(0.14 mm/m)
	Backlash	0.0007" max.	(0.018 mm)

The OMAX control system computes exactly how the feed rate should vary for a given geometry in a given material to make a precise part.

The algorithm actually determines desired variations in the feed rate every 0.0005" (0.012 mm) along the tool path

OMAX uses a PC to compute and store the entire tool path and feed rate profile and then directly drive the servo motors that control the X-Y motion.

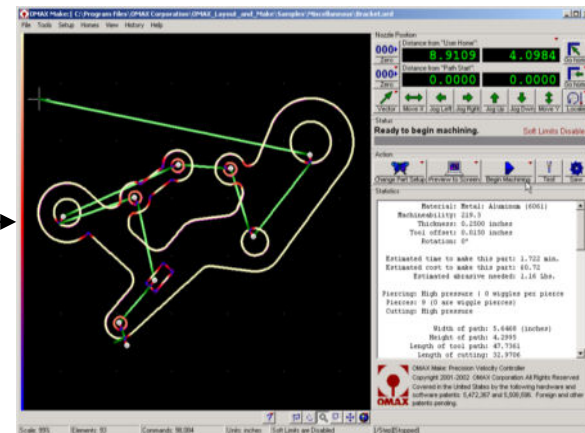
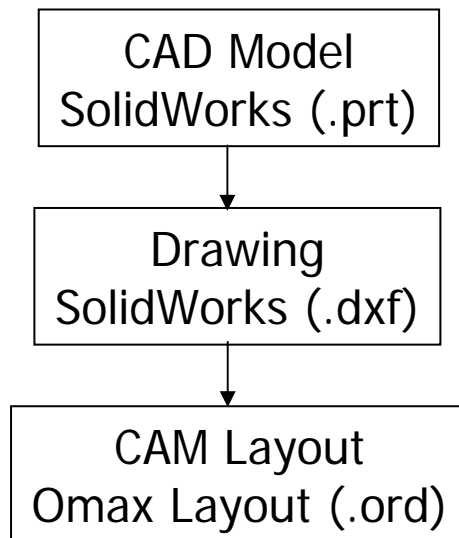

Omax Make

(1) Run the Omax Software!

Estimated time to make this part: 3.265 min.
Estimated cost to make this part: \$4.08

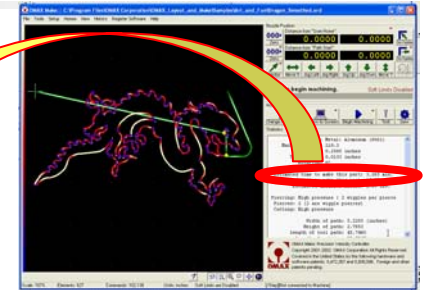

(2) Estimation by hand

$$Cost_{manufac} = C_o t_{manufac}$$

$$(C_o = \$1.25 / \text{minute})$$

$$t_{manufac} = t_{cutting} + t_{traverse}, \quad t_{cutting} \gg t_{traverse}$$

$$\cong t_{cutting}$$

$$= \sum_i \frac{l_i}{u_i}$$

- Break up curves into linear and nonlinear sections
- Measure curve lengths and calculate cutting speeds
- Solve for cutting times for each curve and sum

Overhead cost estimate in
Aero/Astro machine shop

- **Linear cutting speed, u_{linear}**
 - Good approximation for most of the curves in the CAM waterjet cutting route
- **Arc section cutting speed, u_{arc}**
 - Assume if arc radius is less than R_{min}
- **Reduce manufacturing time**
 - Reduce the total cutting length
 - Increase fillet radii
 - Reduce cutting curve lengths

$$u_{linear} = \left[\frac{42.471}{q} \right]^{1.15} \quad [\text{in/min}]$$

$$u_{arc} = \left[1.866R + 9.334e^{-4} \right]^{1.15} \quad [\text{in/min}]$$

Quality Index,	5	4	3	2	1
R_{min}^q (in)	0.15	0.125	0.2	0.3	N/A

Materials and thickness

- Aluminum, tool steel, stainless steel, mild steel and titanium
- Thicknesses up to about 1" (2.5 cm)

Shapes

- An abrasivejet can make almost any two-dimensional shape imaginable—quickly and accurately—in material less than 1" (25 mm) thick.
- The only limitation comes from the fact that the minimum inside radius in a corner is equal to $\frac{1}{2}$ the diameter of the jet, or about 0.015" (0.4 mm).

Low-cost applications where accuracy really has no value

Using a precision abrasivejet as a cross-cut saw

- Just buy a saw !

Applications involving wood

- It's hard to beat a simple jigsaw.

Parts that truly require a 5-axis machine

- This is a much more specialized market.

Aluminum

Aluminum is a light weight but strong metal used in a wide variety of applications.

Generally speaking, it machines at about twice the speed as mild steel, making it an especially profitable application for the OMAX.

Many precision abrasivejet machines are being purchased by laser shops specifically for machining aluminum. Aluminum is often called the "bread and butter" of the abrasivejet industry because it cuts so easily.



A part machined from 3" (7.6 cm) aluminum; Intelli-MAX software lets you get sharp corners without wash-out

Examples

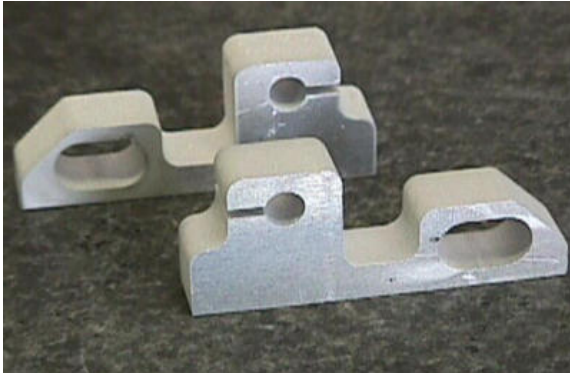

An example of two aluminum parts done in 1/2" (1.3 cm) thick aluminum, which took approximately five minutes to machine

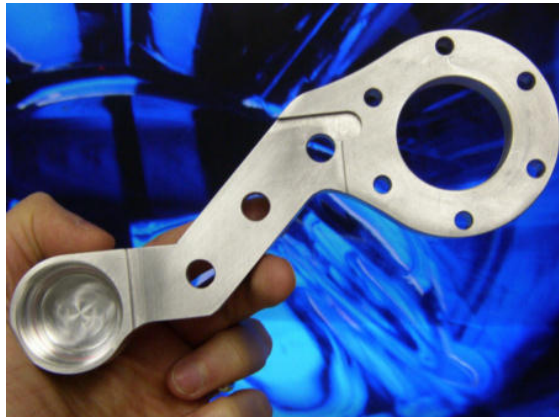

A prototype linkage arm for the Tilt-A-Jet. This part was first "roughed out" on the OMAX. The holes were then reamed out to tolerance, and some additional features (such as pockets) added with other machining processes.

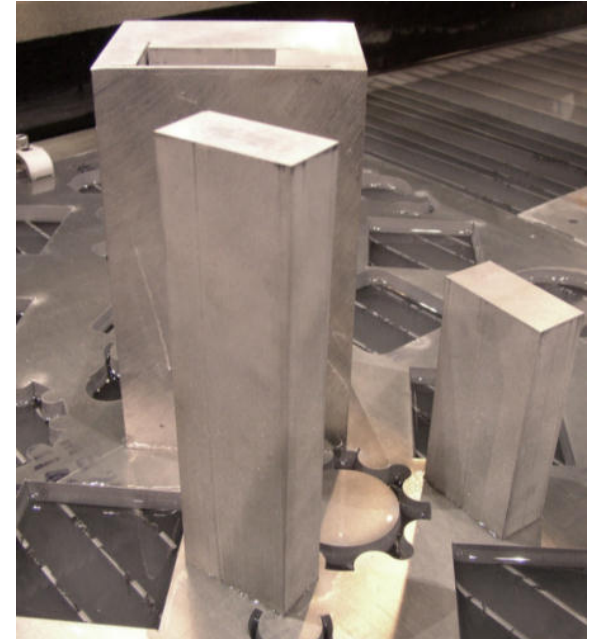

This piece was made from 8" (200mm) thick aluminum as a demonstration of what an abrasivejet can do

A comprehensive Overview of Abrasivejet Technology, Omax Precision Abrasive Waterjet Systems, <http://www.oxam.com/>

Spiral Development (DSM)

- 1 – Requirements Analysis
- 2 – Concept/Sketching
- 3 – CAD Modeling (.prt)
- 4 – FEM Analysis
- 5 – Design Optimization
- 6 – Make Drawing (.dxf)
- 7 – CAM Layout (.ord)
- 8 – Manufacture (Omax)
- 9 – Structural Testing
- 10 – Accept Part

	1	2	3	4	5	6	7	8	9	10
1	1			X					X	
2	X	2		X					X	
3		X	3	X					X	
4			X		X				X	
5										
6		X				6				
7						X	7			
8							X	8		
9								X	9	
10	X			X				X	X	10

