

INFLATIONARY COSMOLOGY: IS OUR UNIVERSE PART OF A MULTIVERSE?

— Alan Guth —



Massachusetts Institute of Technology

*8.286 Opening Lecture
September 8, 2011*

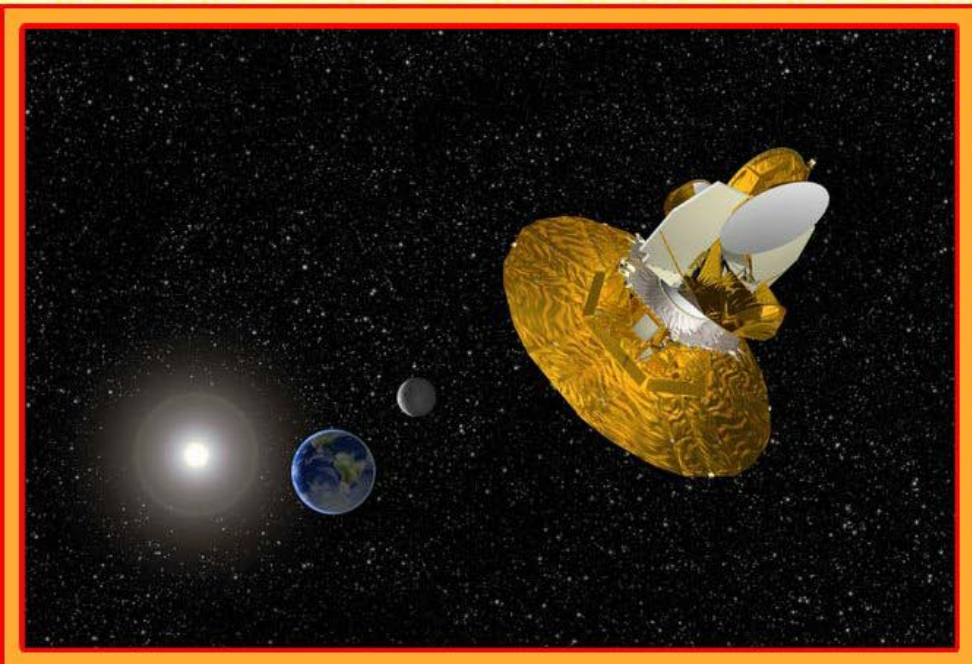

INFLATIONARY COSMOLOGY: IS OUR UNIVERSE PART OF A MULTIVERSE?

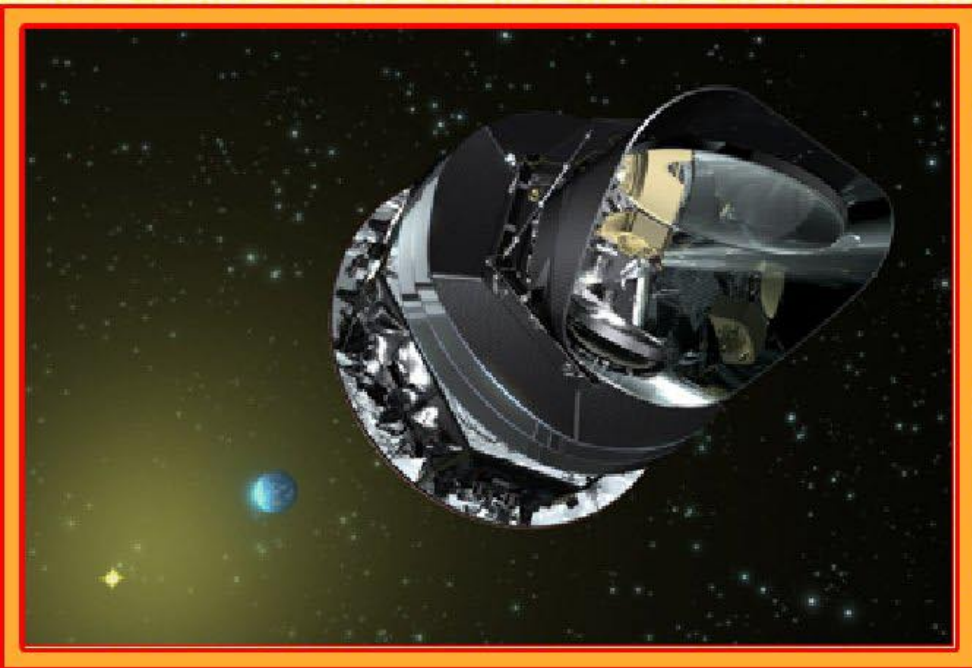

— Alan Guth —



Massachusetts Institute of Technology

*8.286 Opening Lecture
September 8, 2011*

Cosmic Inflation

- ★ Inflation is a modification of the standard big bang theory, providing a very brief

Cosmic Inflation

- ★ Inflation is a modification of the standard big bang theory, providing a very brief “prequel”.

Cosmic Inflation

- ★ Inflation is a modification of the standard big bang theory, providing a very brief “prequel”.
- ★ Inflation can explain the **bang** of the **big bang** (i.e, the outward propulsion), in terms of

Cosmic Inflation

- ★ Inflation is a modification of the standard big bang theory, providing a very brief “prequel”.
- ★ Inflation can explain the **bang** of the **big bang** (i.e, the outward propulsion), in terms of

★ **Miracle of Physics #1:**



Cosmic Inflation

- ★ Inflation is a modification of the standard big bang theory, providing a very brief “prequel”.
- ★ Inflation can explain the **bang** of the **big bang** (i.e, the outward propulsion), in terms of

★ **Miracle of Physics #1:**

Gravitational Repulsion!

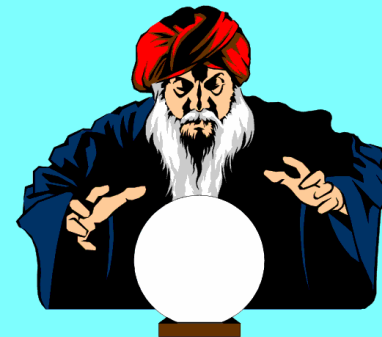

Cosmic Inflation

- ★ Inflation is a modification of the standard big bang theory, providing a very brief “prequel”.
- ★ Inflation can explain the **bang** of the **big bang** (i.e, the outward propulsion), in terms of

★ **Miracle of Physics #1:**

Gravitational Repulsion!



- ★ The combination of general relativity and modern particle theories predicts that, at very high energies, there exists forms of matter that create a gravitational repulsion!

Cosmic Inflation

- ★ Inflation is a modification of the standard big bang theory, providing a very brief “prequel”.
- ★ Inflation can explain the **bang** of the **big bang** (i.e, the outward propulsion), in terms of

★ **Miracle of Physics #1:**

Gravitational Repulsion!

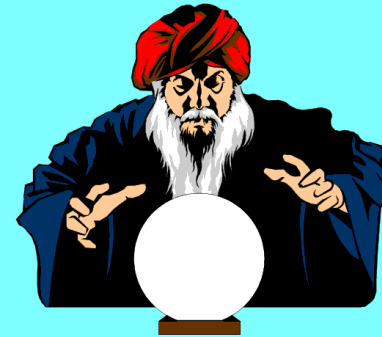

- ★ The combination of general relativity and modern particle theories predicts that, at very high energies, there exists forms of matter that create a gravitational repulsion! (In general relativity, gravitational repulsion is created by negative pressures.)

- ★ Inflation proposes that a patch of repulsive gravity material existed in the early universe — for inflation at the grand unified theory scale ($\sim 10^{16}$ GeV), the patch needs to be only as large as 10^{-28} cm. (Since any such patch is enlarged fantastically by inflation, the initial density or probability of such patches can be very low.)

- ★ Inflation proposes that a patch of repulsive gravity material existed in the early universe — for inflation at the grand unified theory scale ($\sim 10^{16}$ GeV), the patch needs to be only as large as 10^{-28} cm. (Since any such patch is enlarged fantastically by inflation, the initial density or probability of such patches can be very low.)

1 GeV \approx mass energy of a proton.

- ★ Inflation proposes that a patch of repulsive gravity material existed in the early universe — for inflation at the grand unified theory scale ($\sim 10^{16}$ GeV), the patch needs to be only as large as 10^{-28} cm. (Since any such patch is enlarged fantastically by inflation, the initial density or probability of such patches can be very low.)

1 GeV \approx mass energy of a proton.

- ★ The gravitational repulsion created by this material was the driving force behind the big bang. The repulsion drove it into exponential expansion, doubling in size every 10^{-37} second or so!

- ★ The patch expanded exponentially by a factor of at least 10^{28} (~ 100 doublings), but it could have expanded much more. Inflation lasted maybe 10^{-35} second, and at the end, the region destined to become the presently observed universe was about the size of a marble.
- ★ The repulsive-gravity material is unstable, so it decayed like a radioactive substance, ending inflation. The decay released energy which produced ordinary particles, forming a hot, dense “primordial soup.” Standard cosmology began.

- ★ The patch expanded exponentially by a factor of at least 10^{28} (~ 100 doublings), but it could have expanded much more. Inflation lasted maybe 10^{-35} second, and at the end, the region destined to become the presently observed universe was about the size of a marble.
- ★ The repulsive-gravity material is unstable, so it decayed like a radioactive substance, ending inflation. The decay released energy which produced ordinary particles, forming a hot, dense “primordial soup.” Standard cosmology began.

Caveat: The decay happens almost everywhere, but not everywhere — we will come back to this subtlety, which is the origin of eternal inflation.

- ★ The density of the repulsive gravity material was **not lowered** as it expanded!



- ★ The density of the repulsive gravity material was **not lowered** as it expanded!
- ★ Although more and more mass/energy appeared as the repulsive-gravity material expanded, total energy was conserved!

- ★ The density of the repulsive gravity material was **not lowered** as it expanded!
- ★ Although more and more mass/energy appeared as the repulsive-gravity material expanded, total energy was conserved!

★ **Miracle of Physics #2:**

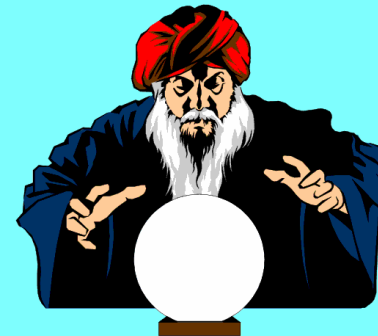

- ★ The density of the repulsive gravity material was **not lowered** as it expanded!
- ★ Although more and more mass/energy appeared as the repulsive-gravity material expanded, total energy was conserved!

★ **Miracle of Physics #2:**

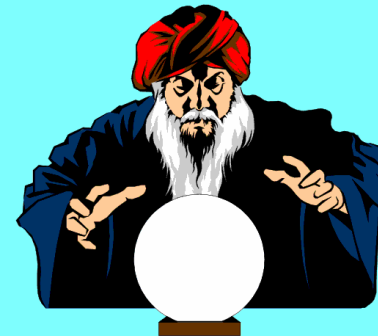

The energy of a gravitational field is negative!

- ★ The density of the repulsive gravity material was **not lowered** as it expanded!
- ★ Although more and more mass/energy appeared as the repulsive-gravity material expanded, total energy was conserved!

★ **Miracle of Physics #2:**

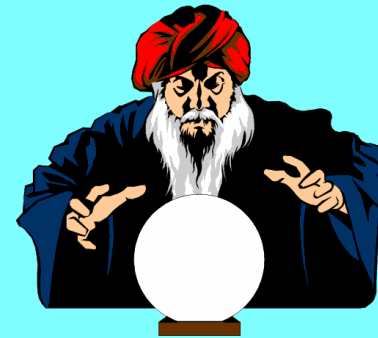

The energy of a gravitational field is negative!

- ★ The positive energy of the repulsive gravity material was compensated by the negative energy of gravity. The **TOTAL ENERGY** of the universe may very well be zero.

Evidence for Inflation

- 1) **Large scale uniformity.** The cosmic background radiation is uniform in temperature to one part in 100,000. It was released when the universe was about 400,000 years old. In standard cosmology without inflation, a mechanism to establish this uniformity would need to transmit energy and information at about 100 times the speed of light.

Evidence for Inflation

- 1) **Large scale uniformity.** The cosmic background radiation is uniform in temperature to one part in 100,000. It was released when the universe was about 400,000 years old. In standard cosmology without inflation, a mechanism to establish this uniformity would need to transmit energy and information at about 100 times the speed of light.

Inflationary Solution: In inflationary models, the universe begins so small that uniformity is easily established — just like the air in the lecture hall spreading to fill it uniformly. Then inflation stretches the region to be large enough to include the visible universe.

2) "Flatness problem:"

Why was the early universe so **FLAT?**



2) "Flatness problem:"

Why was the early universe so **FLAT?**

What is meant by "flat"?



2) "Flatness problem:"

Why was the early universe so **FLAT?**

What is meant by "flat"?

- ★ Flat does not mean 2-dimensional.
- ★ Flat means Euclidean, as opposed to the non-Euclidean curved spaces that are also allowed by Einstein's general relativity.

2) "Flatness problem:"

Why was the early universe so **FLAT?**

What is meant by "flat"?

- ★ Flat does not mean 2-dimensional.
- ★ Flat means Euclidean, as opposed to the non-Euclidean curved spaces that are also allowed by Einstein's general relativity.
- ★ 3-dimensional curved spaces are hard to visualize, but they are analogous to the 2-dimensional curved surfaces shown on the right.

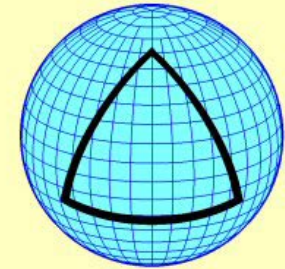

Closed Geometry

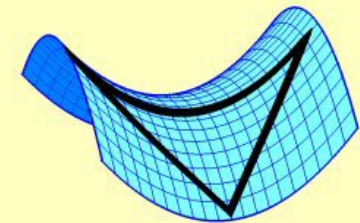

Open Geometry

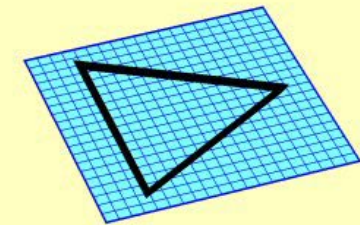

Flat Geometry

- ★ According to general relativity, the flatness of the universe is related to its mass density:

$$\Omega(\textit{Omega}) = \frac{\text{actual mass density}}{\text{critical mass density}},$$

where the “critical density” depends on the expansion rate. $\Omega = 1$ is flat, Ω greater than 1 is closed, Ω less than 1 is open.

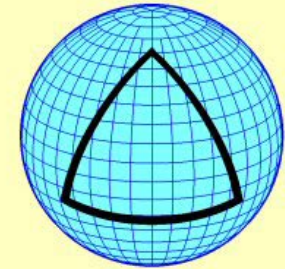

Closed Geometry

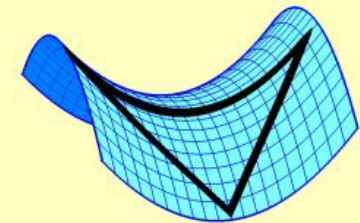

Open Geometry

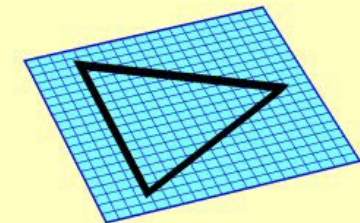

Flat Geometry

- ★ A universe at the critical density is like a pencil balancing on its tip:

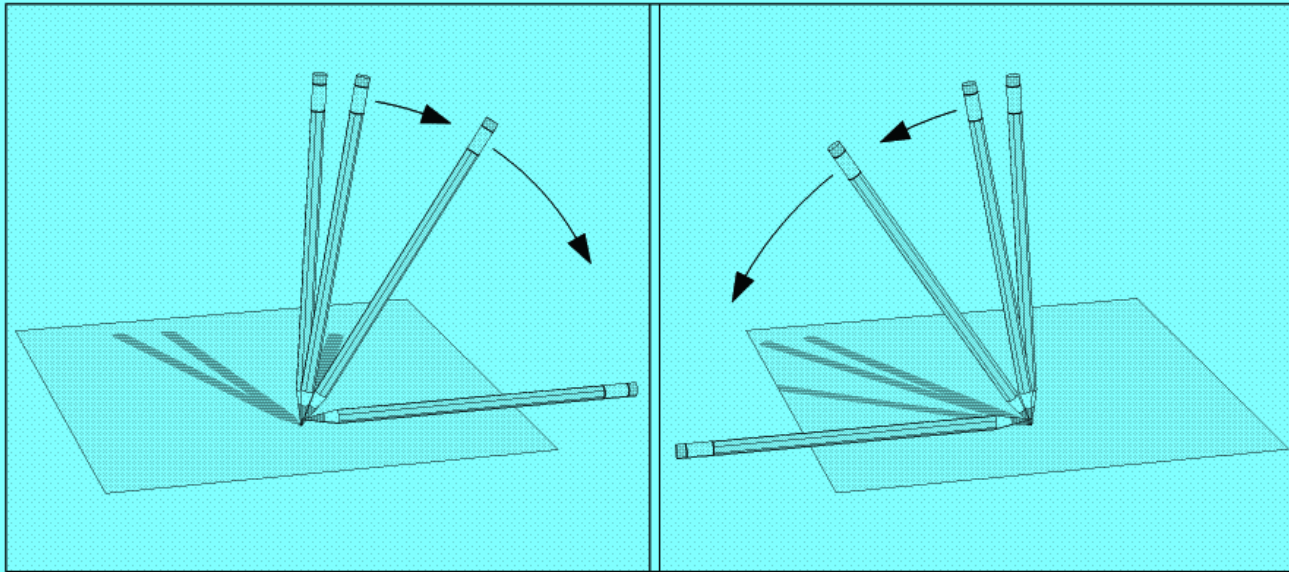

- ★ If Ω in the early universe was slightly below 1, it would rapidly fall to zero — and no galaxies would form.
- ★ If Ω was slightly greater than 1, it would rapidly rise to infinity, the universe would recollapse, and no galaxies would form.

- ★ A universe at the critical density is like a pencil balancing on its tip:

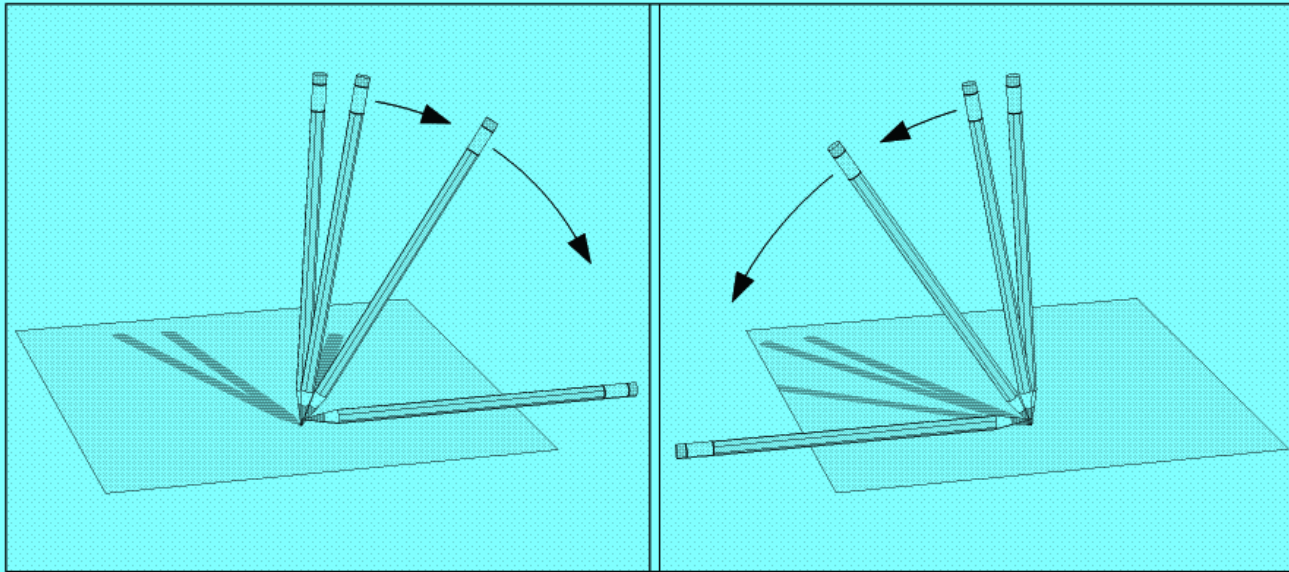

- ★ If Ω in the early universe was slightly below 1, it would rapidly fall to zero — and no galaxies would form.
- ★ If Ω was slightly greater than 1, it would rapidly rise to infinity, the universe would recollapse, and no galaxies would form.
- ★ To be as close to critical density as we measure today, at one second after the big bang, Ω must have been equal to one **to 15 decimal places!**



Inflationary Solution:

Since inflation makes gravity become repulsive, the evolution of Ω changes, too. Ω is driven towards one, extremely rapidly. It could begin at almost any value.



- ★ **Inflationary Solution:** Since inflation makes gravity become repulsive, the evolution of Ω changes, too. Ω is driven towards one, extremely rapidly. It could begin at almost any value.
- ★ Since the mechanism by which inflation explains the flatness of the early universe almost always overshoots, it predicts that even today the universe should have a critical density.

- ★ **Inflationary Solution:** Since inflation makes gravity become repulsive, the evolution of Ω changes, too. Ω is driven towards one, extremely rapidly. It could begin at almost any value.
- ★ Since the mechanism by which inflation explains the flatness of the early universe almost always overshoots, it predicts that even today the universe should have a critical density.
- ★ Until 12 years ago, observation pointed to $\Omega \approx 0.2-0.3$.

- ★ **Inflationary Solution:** Since inflation makes gravity become repulsive, the evolution of Ω changes, too. Ω is driven towards one, extremely rapidly. It could begin at almost any value.
- ★ Since the mechanism by which inflation explains the flatness of the early universe almost always overshoots, it predicts that even today the universe should have a critical density.
- ★ Until 12 years ago, observation pointed to $\Omega \approx 0.2-0.3$.
- ★ Latest observation by WMAP satellite (with 2DF and SDSS galaxy surveys, and supernova Ia observations):

$$\Omega = 1.0052 \pm 0.0064$$

- ★ **Inflationary Solution:** Since inflation makes gravity become repulsive, the evolution of Ω changes, too. Ω is driven towards one, extremely rapidly. It could begin at almost any value.
- ★ Since the mechanism by which inflation explains the flatness of the early universe almost always overshoots, it predicts that even today the universe should have a critical density.
- ★ Until 12 years ago, observation pointed to $\Omega \approx 0.2-0.3$.
- ★ Latest observation by WMAP satellite (with 2DF and SDSS galaxy surveys, and supernova Ia observations):

$$\Omega = 1.0052 \pm 0.0064$$

- ★ New ingredient: Dark Energy. In 1998 it was discovered that the expansion of the universe has been accelerating for about the last 5 billion years. The “Dark Energy” is the energy causing this to happen.

- 3) **Small scale nonuniformity:** Can be measured in the cosmic background radiation. The intensity is almost uniform across the sky, but there are small ripples. Although these ripples are only at the level of 1 part in 100,000, these nonuniformities are now detectable! Where do they come from?

3) **Small scale nonuniformity:** Can be measured in the cosmic background radiation. The intensity is almost uniform across the sky, but there are small ripples. Although these ripples are only at the level of 1 part in 100,000, these nonuniformities are now detectable! Where do they come from?

Inflationary Solution: Inflation attributes these ripples to *quantum fluctuations*. Inflation makes predictions for the pattern of the ripples, and the pattern measured so far agrees beautifully with inflation.

WMAP: Wilkinson Microwave Anisotropy Probe

Images courtesy of NASA/WMAP Science Team

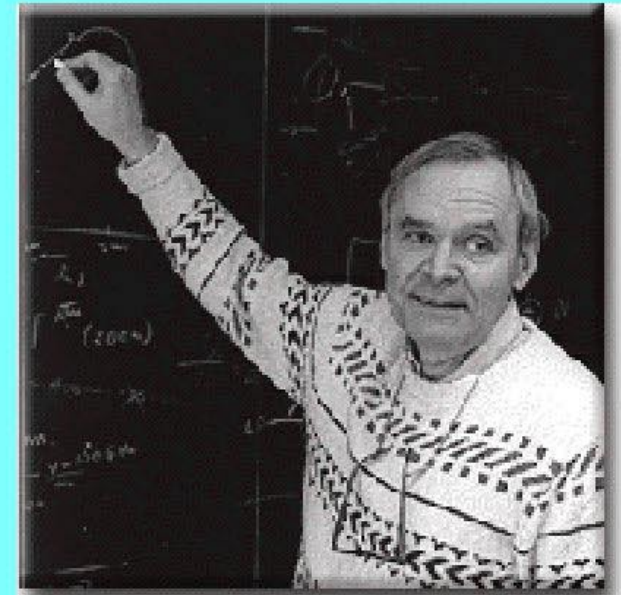

David T. Wilkinson

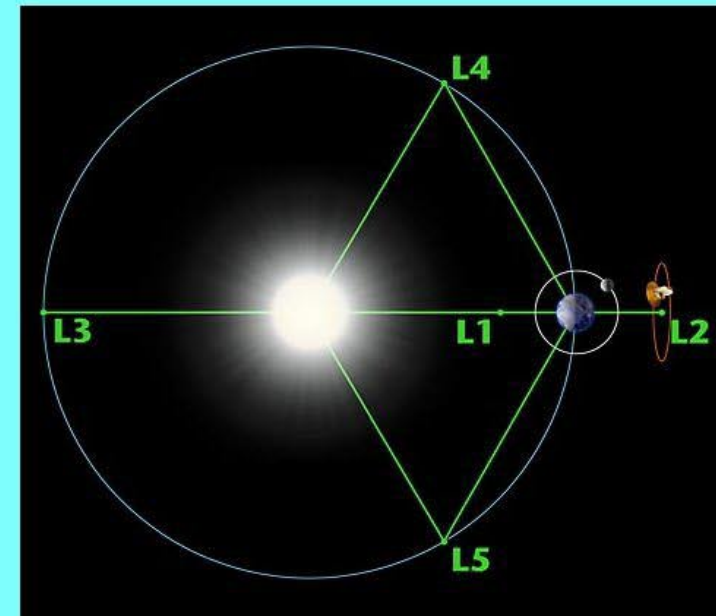
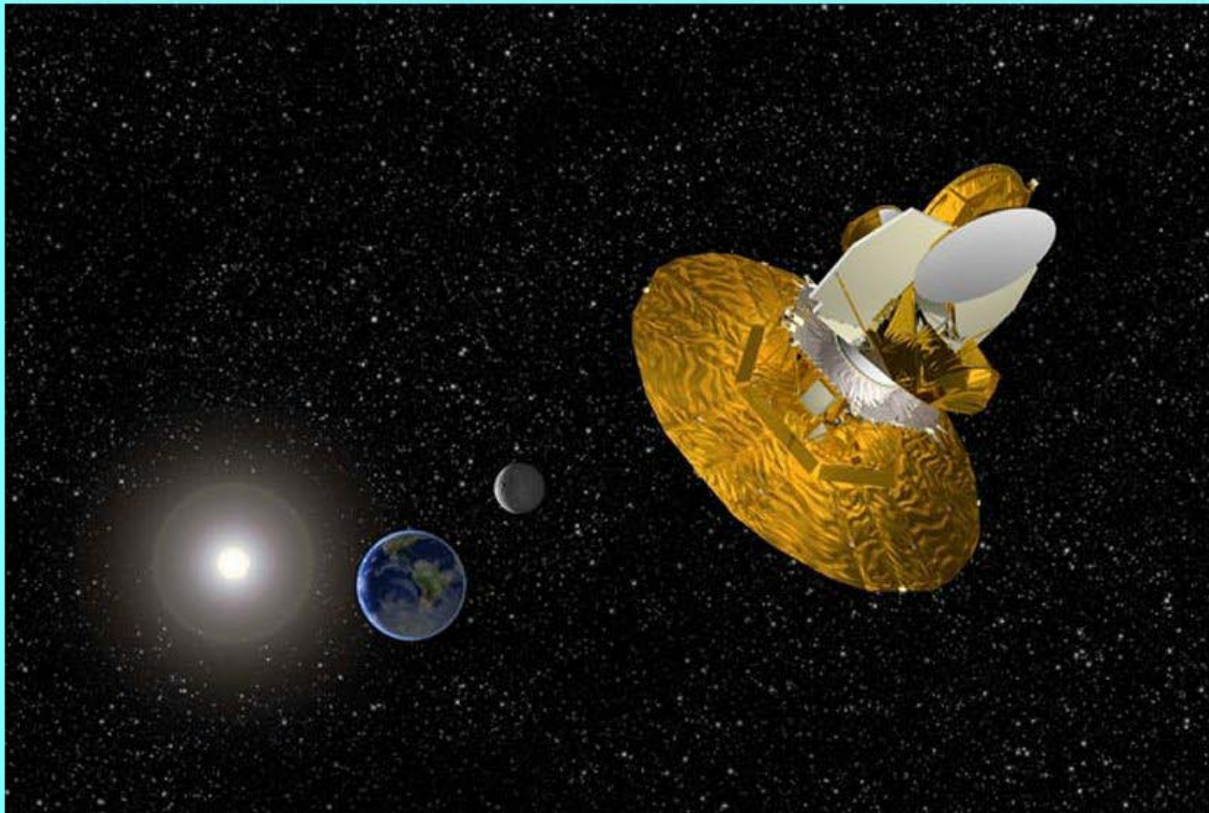

CMB: Comparison of Theory and Experiment

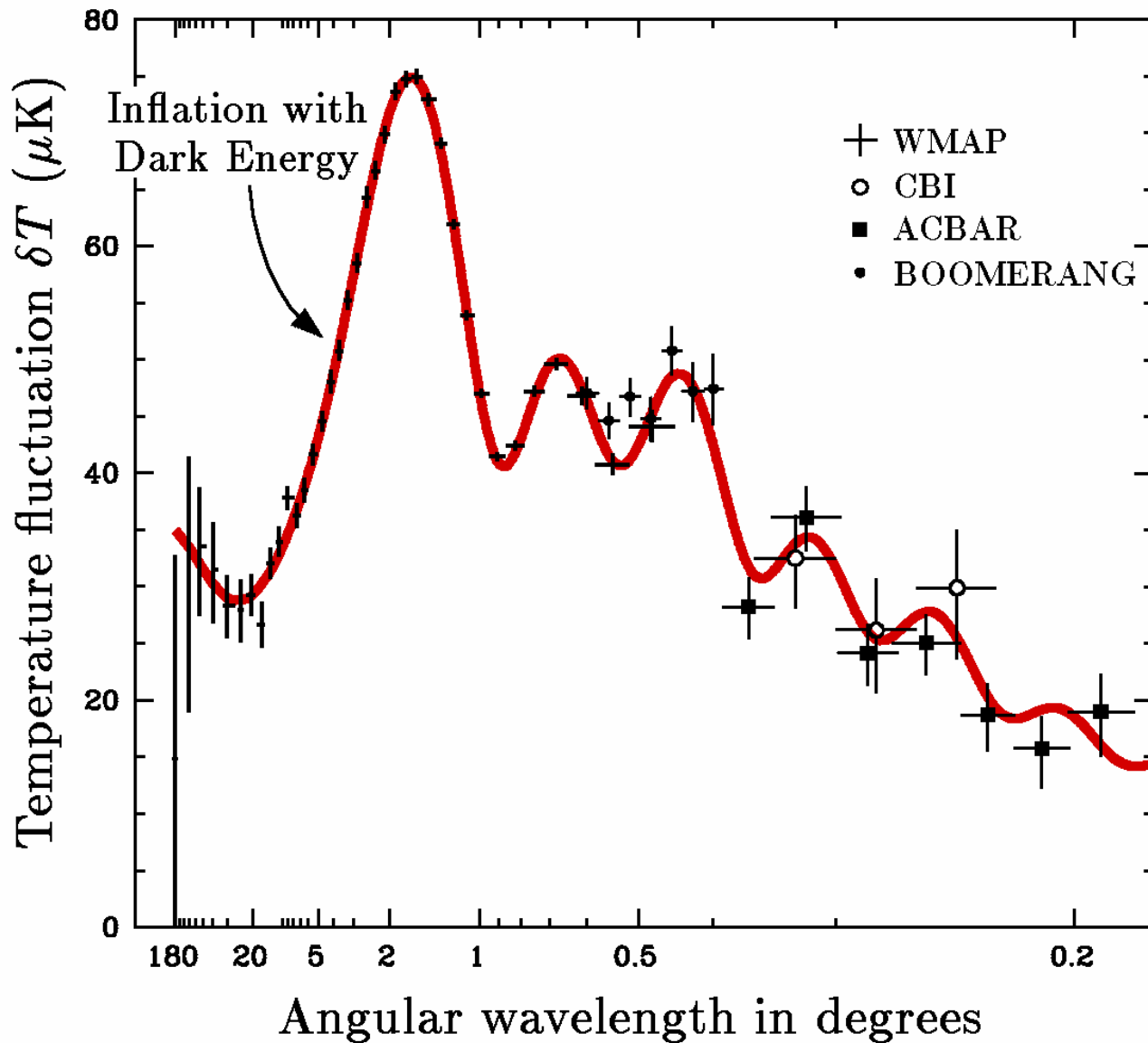

Graph by Max Tegmark,
for A. Guth & D. Kaiser,
Science **307**, 884
(Feb 11, 2005), updated
to include WMAP
3-year data.



CMB: Comparison of Theory and Experiment

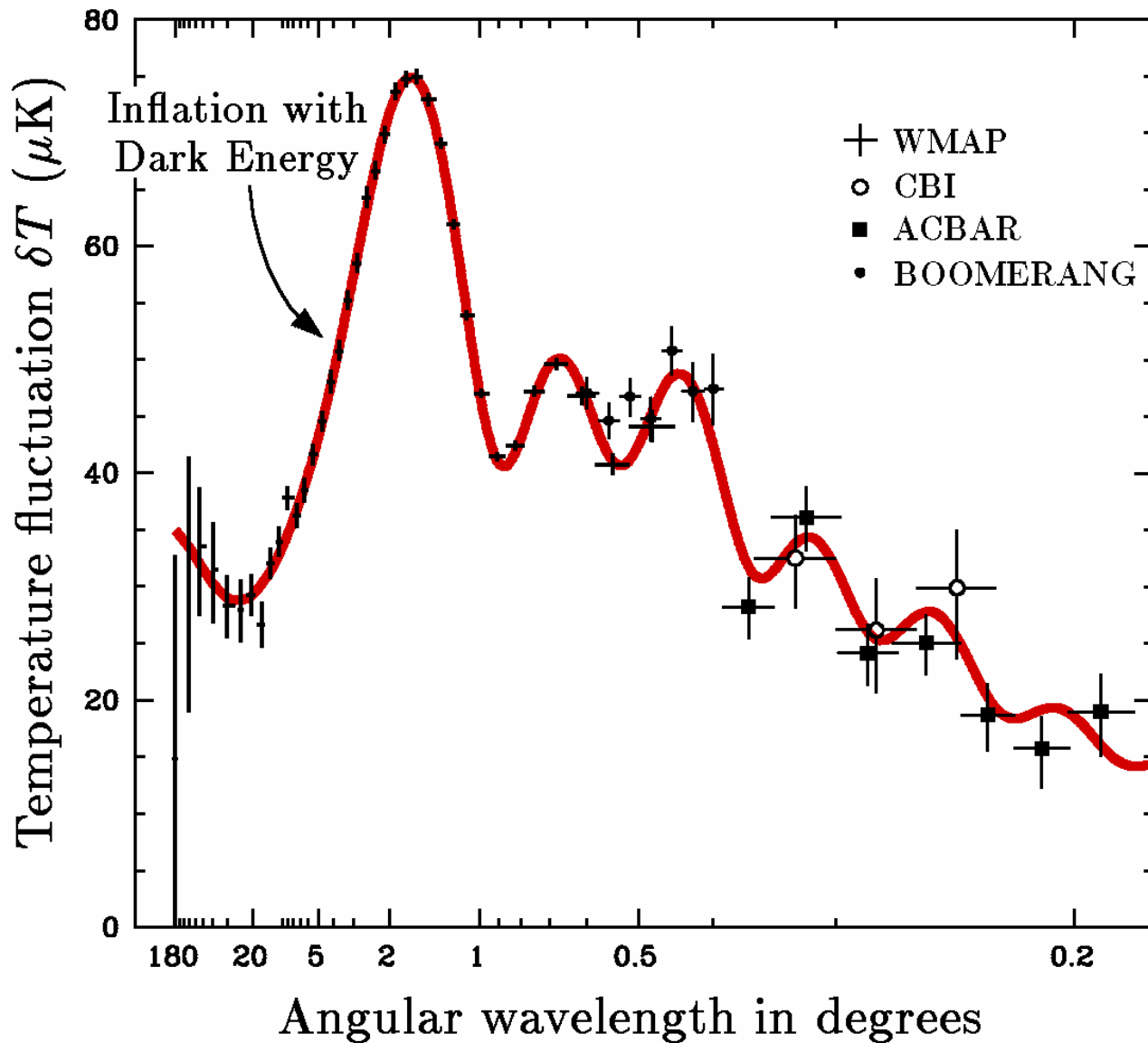

Graph by Max Tegmark,
for A. Guth & D. Kaiser,
Science 307, 884
(Feb 11, 2005), updated
to include WMAP
3-year data.

CMB: Comparison of Theory and Experiment

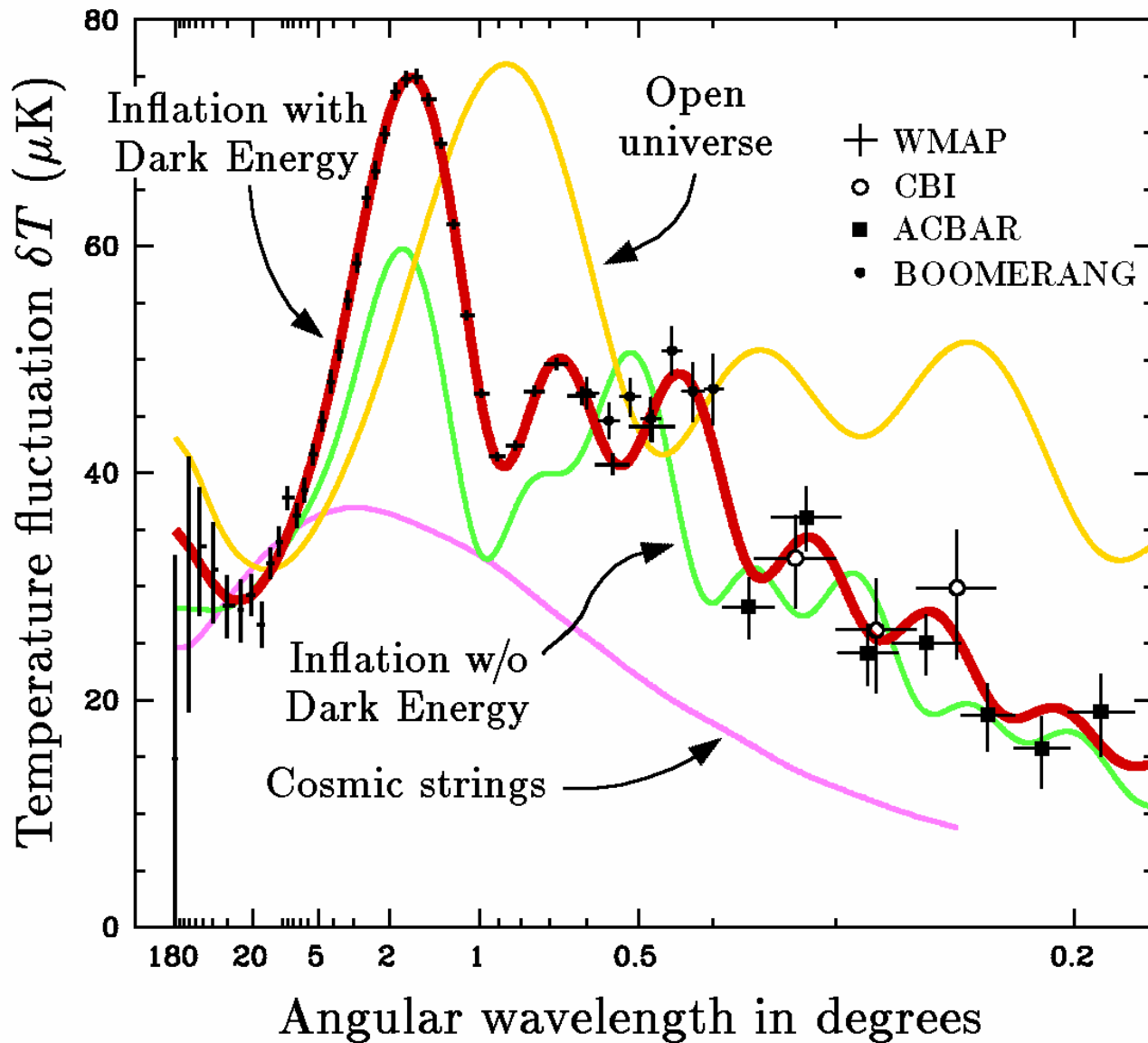

Graph by Max Tegmark,
for A. Guth & D. Kaiser,
Science 307, 884
(Feb 11, 2005), updated
to include WMAP
3-year data.

WMAP 7-YEAR FLUCTUATION SPECTRUM

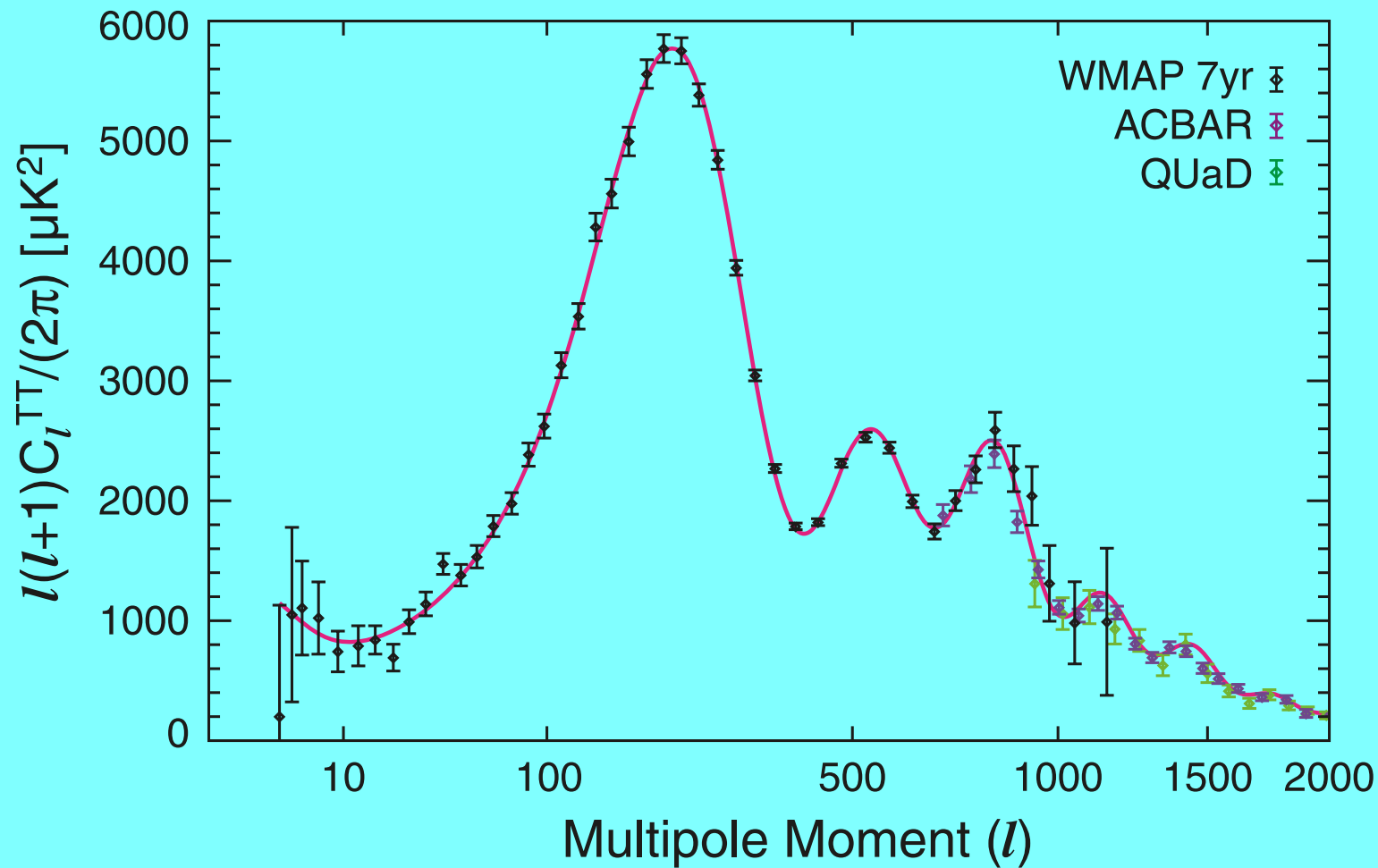

DARK ENERGY

Key Mystery of the Universe

In 1998, astronomers discovered that the universe has been accelerating for about the last 5 billion years (out of its 14 billion year history).

IMPLICATION: Inflation is happening today, so the universe today is filled with a repulsive gravity material. (Within general relativity, this requires negative pressure.) The repulsive gravity material, which apparently fills space, is called the

DARK ENERGY

Key Mystery of the Universe

In 1998, astronomers discovered that the universe has been accelerating for about the last 5 billion years (out of its 14 billion year history).

IMPLICATION: Inflation is happening today, so the universe today is filled with a repulsive gravity material. (Within general relativity, this requires negative pressure.) The repulsive gravity material, which apparently fills space, is called the

“Dark Energy.”

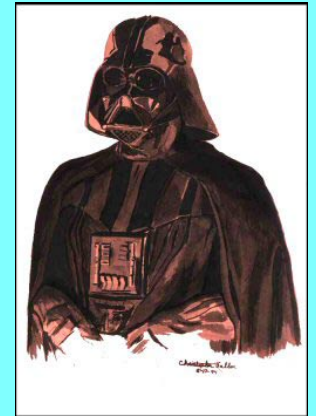

DARK ENERGY

Key Mystery of the Universe

In 1998, astronomers discovered that the universe has been accelerating for about the last 5 billion years (out of its 14 billion year history).

IMPLICATION: Inflation is happening today, so the universe today is filled with a repulsive gravity material. (Within general relativity, this requires negative pressure.) The repulsive gravity material, which apparently fills space, is called the

“Dark Energy.”

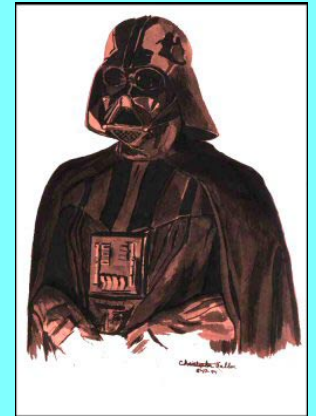

WHAT IS THE DARK ENERGY?

DARK ENERGY

Key Mystery of the Universe

In 1998, astronomers discovered that the universe has been accelerating for about the last 5 billion years (out of its 14 billion year history).

IMPLICATION: Inflation is happening today, so the universe today is filled with a repulsive gravity material. (Within general relativity, this requires negative pressure.) The repulsive gravity material, which apparently fills space, is called the

“Dark Energy.”

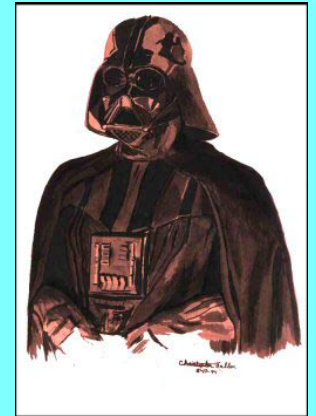

WHAT IS THE DARK ENERGY? Who knows?

DARK ENERGY

Key Mystery of the Universe

In 1998, astronomers discovered that the universe has been accelerating for about the last 5 billion years (out of its 14 billion year history).

IMPLICATION: Inflation is happening today, so the universe today is filled with a repulsive gravity material. (Within general relativity, this requires negative pressure.) The repulsive gravity material, which apparently fills space, is called the

“Dark Energy.”

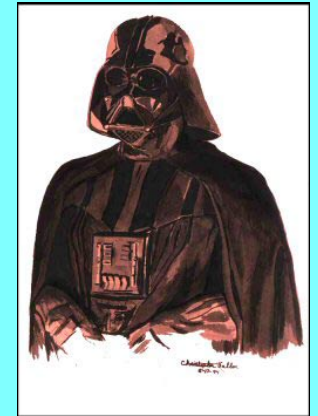

WHAT IS THE DARK ENERGY? Who knows?

SIMPLEST EXPLANATION: Dark energy = vacuum energy, also known as a cosmological constant.

The NIGHTMARE of DARK ENERGY

- ★ The quantum vacuum is far from empty, so a nonzero energy density is no problem.
- ★ In quantum field theory, the energy density of quantum fluctuations diverges.
- ★ A plausible cutoff for the fluctuations is the Planck scale, $E_p \approx 10^{19}$ GeV, the scale of quantum gravity.
- ★ Using this cutoff, the estimated vacuum energy density is too large

The NIGHTMARE of DARK ENERGY

- ★ The quantum vacuum is far from empty, so a nonzero energy density is no problem.
- ★ In quantum field theory, the energy density of quantum fluctuations diverges.
- ★ A plausible cutoff for the fluctuations is the Planck scale, $E_p \approx 10^{19}$ GeV, the scale of quantum gravity.
- ★ Using this cutoff, the estimated vacuum energy density is too large

It is too large by 120 orders of magnitude!

Universe to Multiverse

- ★ The repulsive gravity material that drives the inflation is metastable. In any one location, the probability of remaining in an inflating state decreases with time — usually exponentially.

Universe to Multiverse

- ★ The repulsive gravity material that drives the inflation is metastable. In any one location, the probability of remaining in an inflating state decreases with time — usually exponentially.
- ★ BUT, the universe in the meantime is expanding exponentially. In any successful version of inflation, the exponential expansion is faster than the exponential decay!

Universe to Multiverse

- ★ The repulsive gravity material that drives the inflation is metastable. In any one location, the probability of remaining in an inflating state decreases with time — usually exponentially.
- ★ BUT, the universe in the meantime is expanding exponentially. In any successful version of inflation, the exponential expansion is faster than the exponential decay! Therefore,

The volume that is inflating increases with time, even though the inflating material is decaying!

Universe to Multiverse

- ★ The repulsive gravity material that drives the inflation is metastable. In any one location, the probability of remaining in an inflating state decreases with time — usually exponentially.
- ★ BUT, the universe in the meantime is expanding exponentially. In any successful version of inflation, the exponential expansion is faster than the exponential decay! Therefore,

The volume that is inflating increases with time, even though the inflating material is decaying!

- ★ The inflation becomes eternal — once it starts, it never stops. The inflating region never disappears, but pieces of it undergo decay and produce “pocket universes,” ad infinitum.
- ★ Instead of one universe, inflation produces an infinite number —

Universe to Multiverse

- ★ The repulsive gravity material that drives the inflation is metastable. In any one location, the probability of remaining in an inflating state decreases with time — usually exponentially.
- ★ BUT, the universe in the meantime is expanding exponentially. In any successful version of inflation, the exponential expansion is faster than the exponential decay! Therefore,

The volume that is inflating increases with time, even though the inflating material is decaying!

- ★ The inflation becomes eternal — once it starts, it never stops. The inflating region never disappears, but pieces of it undergo decay and produce “pocket universes,” ad infinitum.
- ★ Instead of one universe, inflation produces an infinite number —

A Multiverse

THE LANDSCAPE OF STRING THEORY

- ★ Since the inception of string theory, theorists have sought to find the vacuum of string theory — with no success.
- ★ Within the past 10 years or so, most string theorists have come to the belief that there is no unique vacuum.
- ★ Instead, there are maybe 10^{500} long-lived metastable states, any of which could serve as a substrate for a pocket universe. **This is the landscape!**
- ★ Eternal inflation can presumably produce an infinite number of pocket universes of every type, populating the landscape.
- ★ Although string theory would govern everywhere, each type of vacuum would have its own low-energy physics — its own “standard model,” its own “constants” of nature, and its own vacuum energy density.

Environmental Selection AKA: The Anthropic Principle

- ★ Consider, as an example, the local density of matter in which we find ourselves — it is about 10^{30} times larger than the mean density of the universe.
- ★ Why is this so?

Environmental Selection AKA: The Anthropic Principle

- ★ Consider, as an example, the local density of matter in which we find ourselves — it is about 10^{30} times larger than the mean density of the universe.
- ★ Why is this so? Chance?

Environmental Selection AKA: The Anthropic Principle

- ★ Consider, as an example, the local density of matter in which we find ourselves — it is about 10^{30} times larger than the mean density of the universe.
- ★ Why is this so? Chance? Luck?

Environmental Selection AKA: The Anthropic Principle

- ★ Consider, as an example, the local density of matter in which we find ourselves — it is about 10^{30} times larger than the mean density of the universe.
- ★ Why is this so? Chance? Luck? Divine Providence?

Environmental Selection AKA: The Anthropic Principle

- ★ Consider, as an example, the local density of matter in which we find ourselves — it is about 10^{30} times larger than the mean density of the universe.
- ★ Why is this so? Chance? Luck? Divine Providence?
- ★ Most of us would presumably accept this as a selection effect: life can evolve only in those rare regions of the universe where the density of matter is unusually high.

- ★ As early as 1987, Steve Weinberg pointed out that the cosmological constant might be explained in the same way.
- ★ Maybe the cosmological constant *IS* huge in most pocket universes. Nonetheless, we must remember that a cosmological constant causes the expansion of the universe to accelerate. If negative, the universe quickly collapses. If large and positive, the universe flies apart before galaxies can form. It is plausible, therefore, that life can arise only if the cosmological constant is very near zero.
- ★ In 1998 Martel, Shapiro, and Weinberg made a serious calculation of the effect of the cosmological constant on galaxy formation. They found that to within a factor of order 5, they could “explain” why the cosmological constant is as small as what we measure.

The Controversy

- ★ A number of physicists regard these anthropic arguments as ridiculous.
- ★ My recommendation is that the anthropic explanation (for anything) should be considered the explanation of last resort.
 - ✿ Until we actually understand the landscape, and the initiation of life, we can only give plausibility arguments for anthropic explanations.
 - ✿ Hence, the anthropic arguments only become attractive when the search for more deterministic explanations has failed, as so far is the case for the cosmological constant. (Anthropic explanations are also discussed for many other quantities, including the Higgs mass, the top quark mass, the magnitude of density perturbations.)

Is It Time to Accept The Explanation of Last Resort?



Is It Time to Accept The Explanation of Last Resort?

Your guess is as good as mine!



Is It Time to Accept The Explanation of Last Resort?

Your guess is as good as mine!

- ★ For the cosmological constant, because it seems so hard to explain any other way, it seems like it is time to strongly consider the selection-effect explanation.

Is It Time to Accept The Explanation of Last Resort?

Your guess is as good as mine!

- ★ For the cosmological constant, because it seems so hard to explain any other way, it seems like it is time to strongly consider the selection-effect explanation.
- ★ It is even hard to deny that, as of now, the selection-effect explanation is by far the most plausible that is known.

The Disappointment

- ★ In earlier years, there was a widespread hope that eventually string theory would be able to predict the parameters of the standard model. From the point of view of theorists, this would be great.
- ★ If the landscape picture is correct, it could be that all these values are determined, at least in part, by historical accidents — which means that we have much less predictive power than we hoped.
- ★ This is not the first time something like this has happened. Kepler thought the radii of planetary orbits should be calculable from geometry. Now we treat planetary orbits as historical accidents.

SUMMARY

The Inflationary Paradigm is in Great Shape!

- ★ Explains large scale uniformity.
- ★ Predicts the mass density of the universe to better than 1% accuracy.
- ★ Explains the ripples we see in the cosmic background radiation as the result of quantum fluctuations.

Three Strong Winds Blowing Us Towards the Multiverse — a diverse multiverse where selection effects play an important role

1) Theoretical Cosmology: Almost all inflationary models are eternal into the future. Once inflation starts, it never stops, but goes on forever producing pocket universes.

2) String Theory: String theorists mostly agree that string theory has no unique vacuum, but instead a landscape of perhaps 10^{500} long-lived metastable states, any of which could serve as the substrate for a pocket universe, including our own.

3) Observational Astronomy: Astronomers have discovered that the universe is accelerating, which probably indicates a vacuum energy that is nonzero, but incredibly much smaller than we can understand. One explanation is the anthropic argument: perhaps we see a small vacuum energy density because conscious beings only form in those parts of the multiverse where the vacuum energy density is small.

Bottom Line:

We have never had a model of the universe that works so well



Bottom Line:

We have never had a model of the universe that works so well
(homogeneity, mass density, spectrum of density fluctuations)



Bottom Line:

We have never had a model of the universe that works so well (homogeneity, mass density, spectrum of density fluctuations), or that is so mysterious.



Dark Energy