

THE UPPER LIMIT OF THERMOCOUPLE USE AND THE LOWER LIMIT FOR LINE REVERSAL METHOD USED TO MEASURE TEMPERATURE.

James P. Hartnett, thesis author 1948
William C. Fuller, thesis author 1950
Warren M. Rohsenow, thesis adviser

Heat Measurements Laboratory
Massachusetts Institute of Technology

RESULTS

Chromel-alumel thermocouples of 30, 32, 35 wire gauge tested in an oxidizing (air) atmosphere were found to have long life at temperatures less than 1900 F. At temperatures up to 2600 F. their useful life decreased at increasing temperatures and decreasing diameters (1).

The Sodium-Line Reversal Method was tested to determine how low it could measure temperature successfully. When vapor from pure sodium, not sodium salts, was added to the combustion gas, temperatures could be measured successfully as low as 1950 F. (2).

LOWER TEMPERATURE MEASURING LIMIT FOR CHROMEL-ALUMEL THERMOCOUPLES

Dahl (3) tested 8 - 22 gauge thermocouples above 1600 F. The measured EMF rose slowly with time due to oxidation and metallurgical change. He found the various sized thermocouples began to deteriorate at about 1600 F. and at 2200 F. they failed in 300 hours.

Jim Hartnett (1) built a small furnace of 12 Koalin insulating bricks with a central cavity of 4 - 2.5 - 0.75 inches at the center. At the four corners lengthwise 4 Glo-Bar heaters established the temperature in the cavity. A long life Platinum - 10% Rhodium thermocouple inserted from one side measured the temperature of the cavity. The Chromel-alumel thermocouples, 30 - 32 - 35 gauge, were inserted from the other side and measurements were made between 2000 and 2500 F. the EMF was measured for 20 minutes. After each run about six or eight inches were cut off of the thermocouple end, on the assumption that the effects of oxidation and metallurgical deterioration would occur there on these wire pairs. All four couples were calibrated at the steam, the copper, and sulfur points with cold junctions at the ice point.

Results

At temperatures below 1800F all couples rose to the furnace temperature and remained there during the test. Above 2000 F. the EMF rose slowly above the furnace temperature,

as shown in diagram 1. At increasing temperatures the EMF measured would first rise and then fall below furnace temperature, as shown in diagram 2 and 3. At temperatures above 2550 F. the measured EMF failed to come up to the value it should have had at furnace temperature, as shown in diagram 4. The behavior of the thermocouple EMF measurements indicate metallurgical changes and the strong effect of oxidation as temperature rose. The magnitude of these changes was greater for the smaller diameter thermocouple. We therefore defined, as shown in diagram's 2 and 3, a 10-degree life. During this time interval the reading of the thermocouple would be within ten degrees of the correct reading. The graph in diagram 5 shows the variation of the 10-degree life with temperature and thermocouple diameter.

To use thermocouples above temperatures, 1800 to 2000 F. would require recalibration often, cutting off the tips, and rewelding the junctions. This no doubt would make their use unacceptable at the higher temperatures.

LOWER LIMIT OF USE OF THE SODIUM D-LINE METHOD FOR TEMPERATURE MEASUREMENT

Bill Fuller (2) investigated how low in temperature the sodium D- line method could be used successfully. By using pure sodium instead of sodium salts he was able to get good readings as low as 1950 F.

Bill was able to use the furnace built by John A. Clark (4) to supply hot combustion gases for his measurements. John had built this furnace for his own thesis, which addressed a more modern problem of measuring the thermodynamic adiabatic temperature in high-speed combustion gases. The apparatus included an electrically heated triple radiation shielded thermocouple, which measured the temperature of the flowing gas. The sodium was vaporized into the gas stream by using either of pure sodium or sodium nitrate, sodium bromide, or sodium chloride. The hot gas was viewed through a spectrometer having a triangular prism, a collimator tube, and a slit. At higher temperatures the two sodium D-lines (5890 and 5896 angstroms) become visible.

The remainder of the equipment is a tungsten filament comparator lamp. This sodium D- line method consists essentially of viewing the comparator lamp through the hot gas, represented by the flame in the diagram, with the spectrometer system. At high temperatures the two sodium D-lines from the gas are visible in the spectrometer.

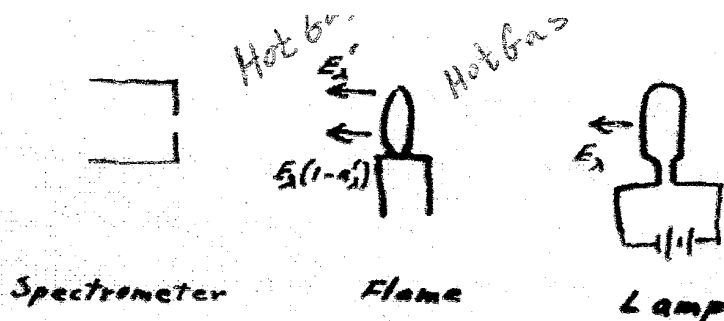

The intensity of the lamp is adjusted until a sodium line becomes invisible. Then the lamp temperature is equal to the gas temperature. The lamp temperature had been previously measured with an optical pyrometer, and a calibration curve was drawn.

In these tests the gas temperature was set and measured with the heated shielded thermocouple. Then the lamp temperature was adjusted until the D-line disappeared. This temperature was recorded and compared with the measured gas temperature.

Much of the work of this thesis involved getting various parts of this equipment to work properly, including four or five designs of equipment to vaporized the sodium and sodium salts.

Results

¹Tests were run from around 2200 F. and down to as low as 1950 F. when sodium metal was evaporated into the gas stream. Below this temperature the D-line was not bright enough to make the measurements. With the sodium salts the D-line disappeared at temperatures above 1950 F.

Bibliography

1. "Accuracy Life of Fine Wire Chromel-Alumel Thermocouples", James P. Hartnett, MS thesis, mechanical engineering, MIT, June 1948.
2. "Experimental Investigation of Temperature Measurement by Sodium D- line Reversal Method." William C. Fuller, MS thesis, mechanical engineering, MIT, May 1950.
3. "Stability of Base Metal Thermocouple in air from 800 to 2200 F", A I Dahl, Journal of Research, National Bureau of Standards, Vol. 24, Feb. 1940.
4. "Analysis and Experimental Investigation of a Method for Determining the Thermodynamic Temperature of High Velocity Combustion Gases", M S. thesis, Mechanical Engineering, MIT June 1949.

ATTEMPT AT HYDRAULIC ANALOGY
OF INSULATION ON A FINITE LENGTH CYLINDER

Ephraim M Sparrow, non thesis author 1947
Warren M Rohsenow, non thesis advisor

Heat Transfer Laboratory
Massachusetts Institute of Technology

In December 1947 Eph Sparrow, then working on an MS, came to me asking if there wasn't some small project he could do instead of going home for Christmas. Just before this time Dusenberie's book on finite differences was published. There he solved a problem of conduction through insulation on a finite L/D cylinder. I suggested that we try to build a hydraulic analogy for the insulation. Eph made up 5 different diameter open-ended cans. With three setscrews near the top of the cans, one can could be placed inside the other on centers with different end gaps. Water added to the space between the cans provided different magnitudes of $L/2$. This provided a variety of magnitudes, r_i, r_o and $L/2$.

We were surprised to find Cambridge water was indeed a good enough conductor to run the experiments. Obviously we could not use AC current, which would have provided as with an RC circuit. Therefore we used DC. We transformed the current and voltage drop into a Heat Transfer equivalent formula:

$$S = k\Delta T / (q / A_i)$$

Where

$$S = r_i \ln (r_o / r_i) \text{ at } L/r_i = \text{inf.}$$

$$S = t_e \text{ at } L/r_i = 0$$

$$t_e = \text{end thickness}$$

When we plotted the above shape factor, S, against L/r the magnitude fell below $r \text{ sub } i \ln (r_o/r_i)$ long before L got to infinity. See graph. The wrong answer was caused by an electrical contact resistance between the water in the metal can surface.

At this point Christmas holidays ended and so did this project!

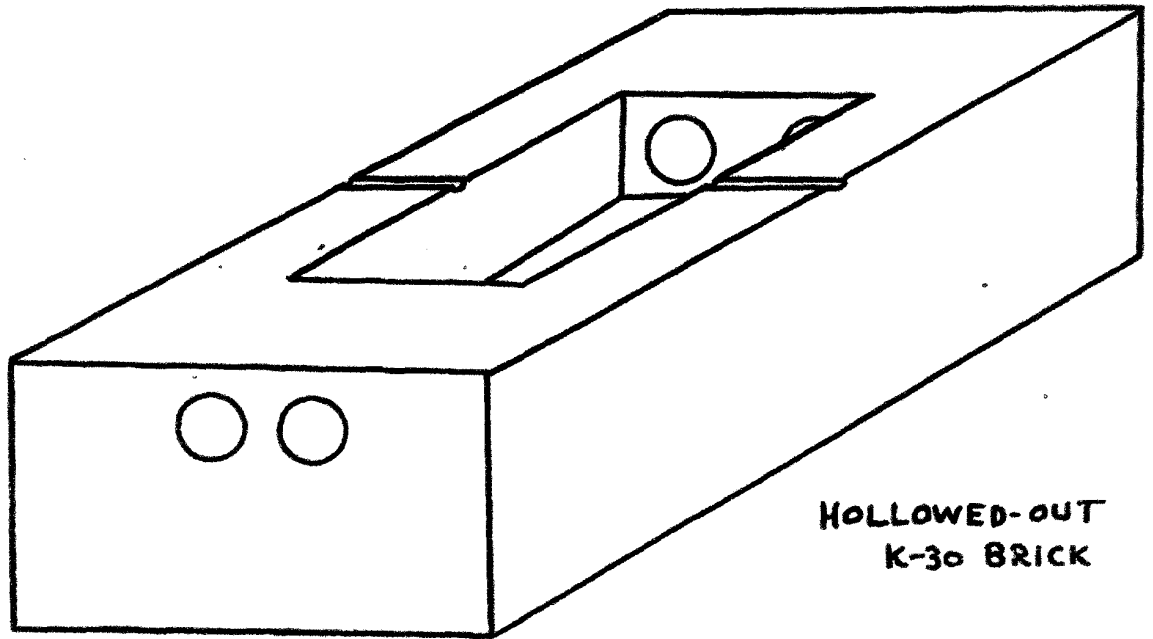

HOLLOWED-OUT
K-30 BRICK

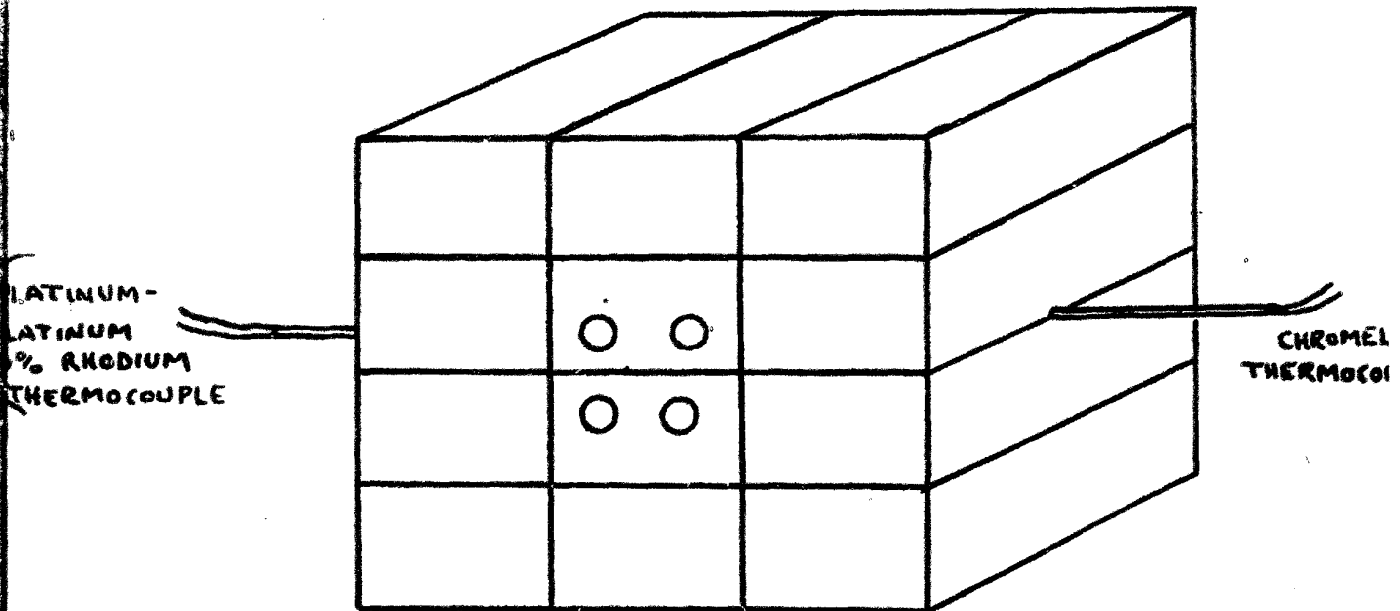

PLATINUM-
PLATINUM
10% RHODIUM
THERMOCOUPLE

CHROMEL
THERMOCOUPLE

FURNACE ASSEMBLY

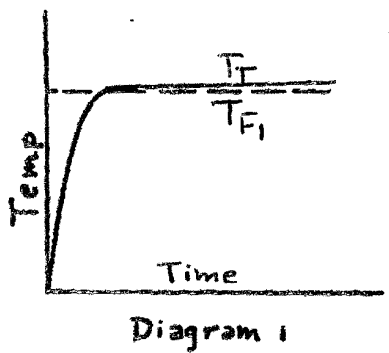

Diagram 1

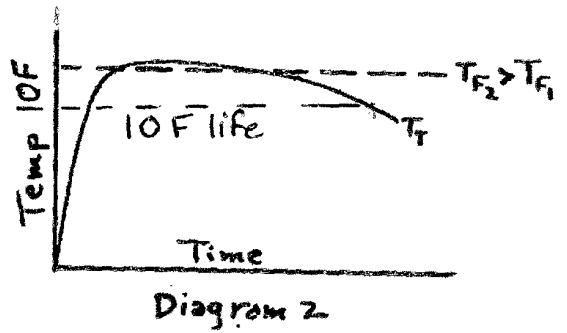

Diagram 2

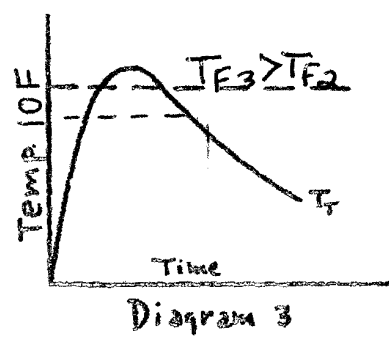

Diagram 3

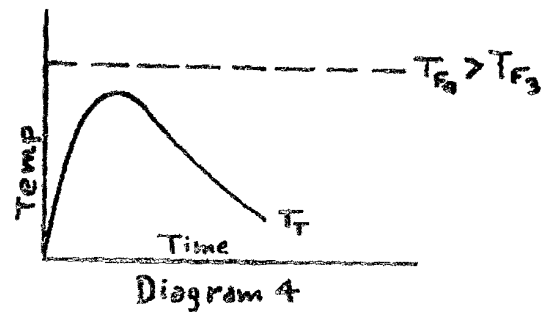

Diagram 4

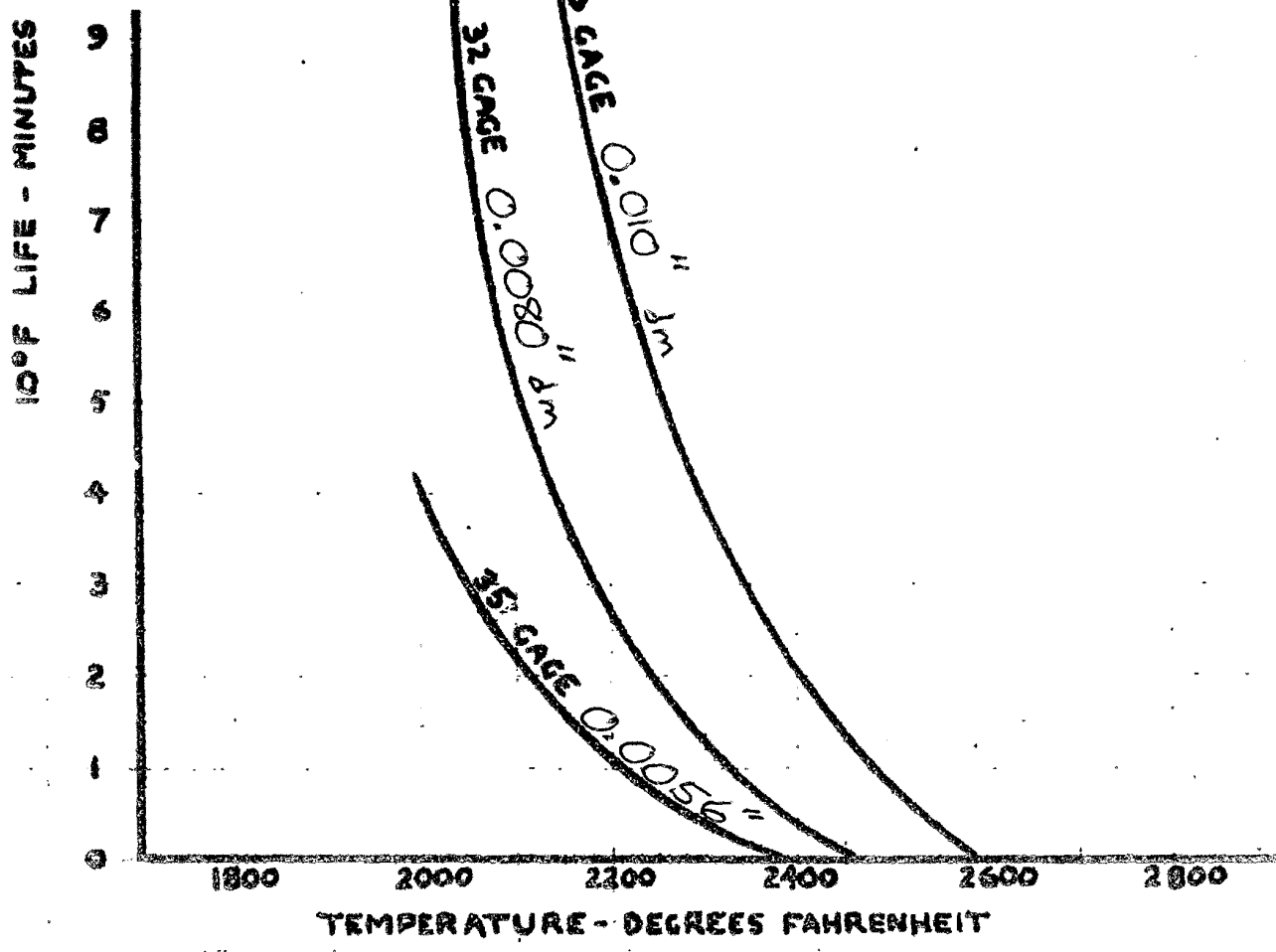
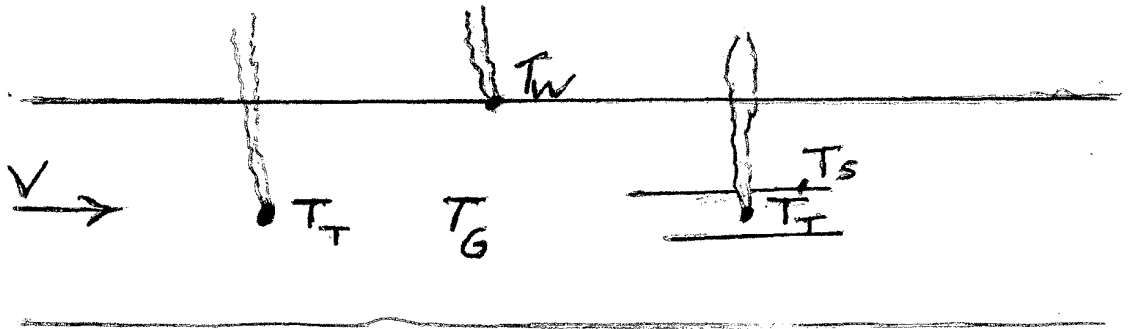
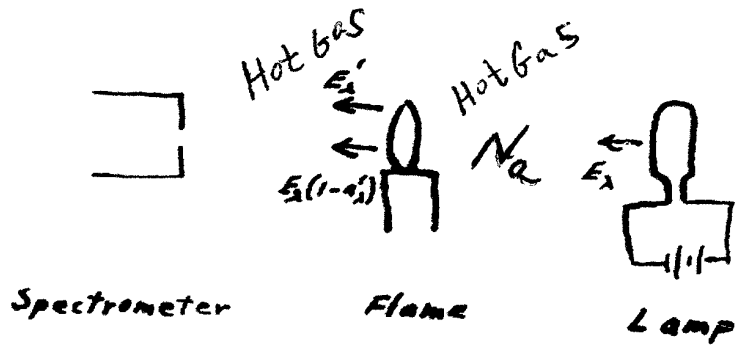
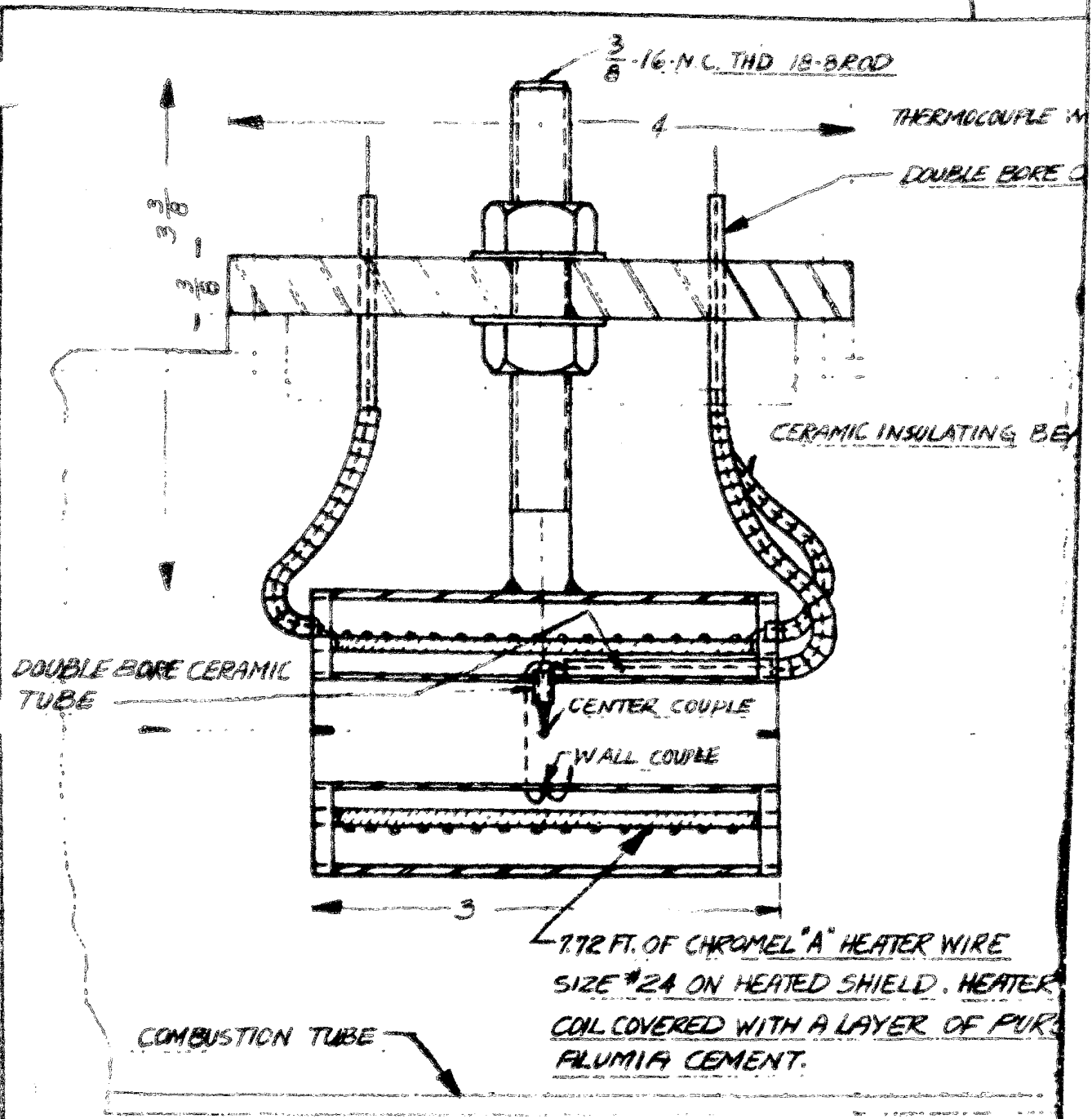

FIG 5



$$h_T (T_G - T_T) = \epsilon_T \sigma (T_T^4 - T_w^4)$$



D-7

HEATED SHIELD THERMOCOUPLE

