

Present Status and Points of Discussion for Future Energy Systems in Japan from the Aspects of Technology Options

Michihisa KOYAMA^{1,2}, Seiichiro KIMURA², Yasunori KIKUCHI^{2,3},
Takao NAKAGAKI⁴ and Kenshi ITAOKA²

¹*Inamori Frontier Research Center, Kyushu University, 744 Motoooka, Nishi-ku, Fukuoka-shi, Fukuoka 819-0395, Japan*

²*International Institute for Carbon-Neutral Energy Research, Kyushu University, 744 Motoooka, Nishi-ku, Fukuoka-shi, Fukuoka 819-0395, Japan*

³*Presidential Endowed Chair for "Platinum Society," The University of Tokyo, 7-3-1 Hongo, Bunkyo-ku, Tokyo 113-0033, Japan*

⁴*Department of Modern Mechanical Engineering, Waseda University, 3-4-1 Okubo, Shinjuku-ku, Tokyo 169-8555, Japan*

Keywords: Future Energy System, Present Status, Japan's Energy System, Fair Comparison

It has been an important target to realize a sustainable energy usage in the future, regardless of the country. Japan is now compelled to consider a new paradigm of energy policy due to the nuclear power plant failures after March 11, 2011. To discuss the ideal or a favorable future of Japan's energy, understanding the present status as well as the available energy options in the future will be an initial step, followed by discussion of the issues related to each option. The aim of this article is to summarize the present status of Japan's energy systems and to clarify the major points of discussions for the realization of future sustainable energy systems. In addition, the major options of both energy supply and demand sides are summarized. The issues for realizing the future energy systems are discussed from the large-scale penetration of renewable systems, the demand side energy management and savings, the mobility, and the centralized electricity grid viewpoints, to provide a common basis for the discussion of future energy systems in Japan.

Introduction

Future energy policies have been an important issue in every country in the world when considering a sustainable future society. In the energy policy, the choices of primary resources, their supply chains, and technologies including the infrastructure are essentially important as well as the promotion of the options chosen. The International Energy Agency (IEA) has presented options for future energy scenarios considering the greenhouse gas (GHG) emissions from all over the world and discussed the schemes of key technologies (IEA, 2010). In the IEA's perspectives, it is pointed out that currently developing or spreading technologies have large potentials to reduce the GHG emission associated with the energy consumption by human activities. Referring to such global perspectives, energy policies specific to each country have been enacted in the last decades. Japan is obliged to change the direction of future energy policy after the great east Japan earthquake on March 11, 2011 and the subsequent nuclear power plant failure (Fukushima *et al.*, 2011). While the roles of nuclear energy in Japan's future energy are still controversial, it is expected that nuclear energy will not increase in capacity. This means

that the paradigm before 3.11, i.e., increasing the roles of nuclear energy to reduce GHG emissions for mitigating the global warming, has now become an unacceptable or at least less probable option. It is, therefore, necessary to discuss the paradigm in a future sustainable energy society in Japan. After 3.11, safety or the lowest risk and resilience from disaster have become important concerns in the discussion of Japan's energy, in addition to the traditional 3E's: environmental protection, energy security, and economic efficiency. Among those five concepts, safety and resilience can be regarded as urgent near term discussion issues.

Further, we need to consider a variety of aspects when we discuss the feasible options for the future energy systems in addition to the aforementioned aspects: e.g., limited availability of key elements required for constructing energy devices may limit the penetration of technologies into the society, thus recycling or reducing the amount used will promote their penetration (Fukushima *et al.*, 2004). While biomass resources are expected to play an increased role in the future, the limited resource of phosphorous, a vital element for all living species, may pose a big question on its large-scale usage for inedible biomass (Matsubae *et al.*, 2011). To address the diverse aspects of energy, holistic and fair analyses and a discussion on a variety of energy options considering a reasonable time horizon are important.

The approach to discuss the directions and pathways to a sustainable energy society can be classified into descriptive and normative approaches, as defined by McDowall and

Received on December 13, 2013; accepted on April 25, 2014

DOI: 10.1252/jcej.13we345

Correspondence concerning this article should be addressed to M. Koyama (E-mail address: koyama@ifrc.kyushu-u.ac.jp).

Eames (2006). Either descriptive or normative, we believe it is important to first understand the present status of energy use and the present technology options, then to identify important energy options and related technologies with high potential to contribute to Japan's future energy. Drawing pathways to an ideal status in the far future will require both descriptive and normative ways, i.e. forecasting the future considering the present trend and backcasting from the future to the present. Those steps will lead to the clarification of discussion points for envisioning the ideal status of Japan's future energy. In this review paper, we summarize the present status mainly from the aspects of technology options as a first step to develop a feasible pathway toward a future sustainable society in Japan. We also have made a preliminary effort to specify some of the discussion points considering the present trends and the near term targets already organized by local governments in Japan.

1. Present Status

1.1 Electric power supply capacity shortage after March 11, 2011

After the great east Japan earthquake, Japan has faced a shortage of electric power supply capacity. The shortage has been classified into three types. The first one is the shortage in March 2011. The supply capacity shortage was due to the damage of many thermal plants and the stop of nuclear power plants of the Tokyo Electric Power Company (TEPCO). TEPCO conducted rolling blackouts in its managing area during March 14 to March 27 when the demand was expected to exceed the supply capacity. Another is the shortage in the summer of 2011. This shortage has the same origin as the above. TEPCO has made efforts to recover the damaged thermal power plants as well as to restart the old thermal power plants that were legally in decommission and waiting for deconstruction. Thus, the shortage was not observed during the spring season with moderate demand. However, even after the recovery and the restart of thermal power plants, TEPCO did not have the supply capacity to

cover the peak demand in summer even considering the possible power interchange from other electric power companies (EPCO's). Thus, the government summarized the directions to cut the peak demand by 15% at the demand-side (METI, 2011b). It includes the regulation to the industrial contract consumers, the curbing of electricity use during the peak demand time of the day, the replacement of inefficient electric appliances, etc. The shortages after the summer of 2011, i.e. winter and summer peak demand periods in 2012 and 2013 have different origin, i.e. the shutdown of nuclear power plants for the periodic inspection of nuclear power plants. Therefore, the influence was on all regions of Japan except Okinawa and islands disconnected from the main grid. Similar measures for the shortage are discussed in a more moderate way during the periods of the supply capacity shortage. Though some of the measures taken after March 11, 2011 have shown implications such as the importance of energy savings at the demand side, the short-term urgent measures and long-term sustainable measures can be different. Therefore, we first summarize the present status in the following sections to consider the sustainable future directions.

1.2 Overview of Japan's energy

In 2010, the primary energy consumption of Japan ranked fifth after China, the United States, Russia and India, occupying approximately 4% of the world energy consumption (IEA, 2012). Japan's energy self-sufficiency ratio nowadays is 4% without counting the uranium for nuclear power generation (METI, 2011a). Japan thus spends a considerable amount of procurement cost to import primary energy resources from abroad.

Figure 1 shows the Japanese energy flow for FY2010, constructed on the basis of the comprehensive energy statistics by the Agency for Natural Resources and Energy (ANRE), Ministry of Economy, Trade and Industry (METI), Japan (2012). The left side of the figure shows the primary energy resources, and the flows to the corresponding sectors such as electricity generation, household usage, commercial, in-

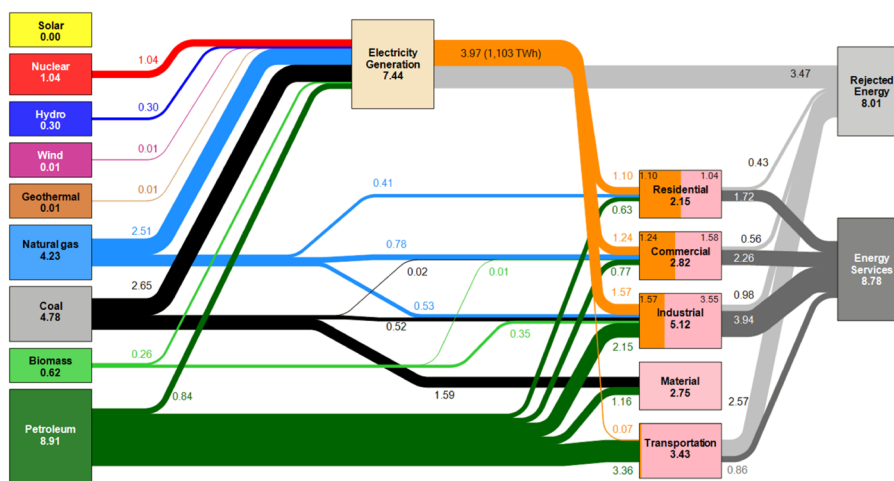

Fig. 1 Japan energy flow in FY2010 (HHV Base); based data from ANRE (2012)

dustrial and transportation are shown quantitatively. Note that the efficiency of the energy usage in each sector is considered: the energy efficiency of renewable energy and nuclear power generation is calculated as 100%. Energy use efficiency is assumed to be 25% in the transportation sector and 80% in residential, commercial and industrial sectors, like in the Lawrence Livermore National Laboratory (LLNL) statistics (LLNL, 2013). Note that each value possesses an error up to 2%.

In FY2010, Japan consumed 17.00 EJ of primary energy except for the usage of 2.75 EJ in basic materials industries such as iron & steel making and raw chemical materials syntheses. The consumption to generate electricity from primary energy was 7.44 EJ. Eighty percent was covered by fossil fuels; i.e. natural gas, coal, and petroleum. Japan thus used ca. 22% of imported fossil fuel in the electric power generation sector. Nuclear power, which did not operate

at all in March 2014, contributed to one fourth of the total electricity supply until the great earthquake.

Figure 2 depicts the transition of annual primary energy consumptions in Japan from FY1990 to FY2010. It can be seen that the total energy consumption is saturated at the level of ca. 20 EJ after FY1995 with some fluctuations. When we see the breakdown, the natural gas has increased its role, while the import of petroleum has decreased.

Figure 3 shows the annual import costs for the primary energy resources, constructed on the basis of the trade statistics by the Ministry of Finance Japan (2013). Note that inflation or deflation is not considered in the figure. The gross amount significantly increased since FY2004, even excluding the influence by a speculative bubble that collapsed in 2008. The cost to import primary resources was about 18 trillion yen in FY2010, which accounts for ca. 30% of the total import costs of Japan. It is apparent that Japan depends greatly on foreign countries for primary energy resources,

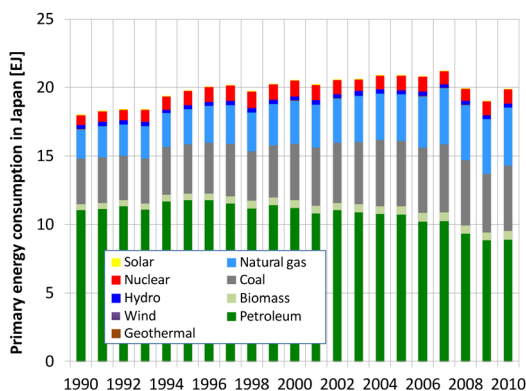

Fig. 2 Primary energy consumption in Japan from FY1990 to FY2010 (HHV Base); base data from ANRE (2012)

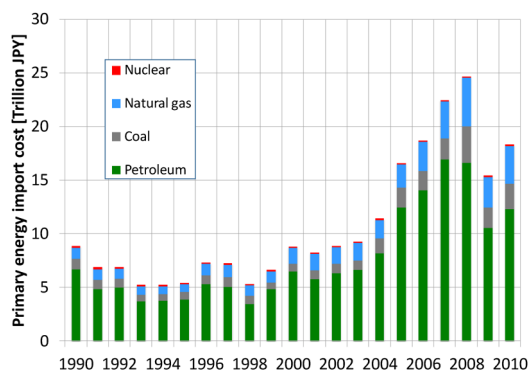

Fig. 3 Energy import cost of Japan from FY1990 to FY2010; base data from MOFJ (2013)

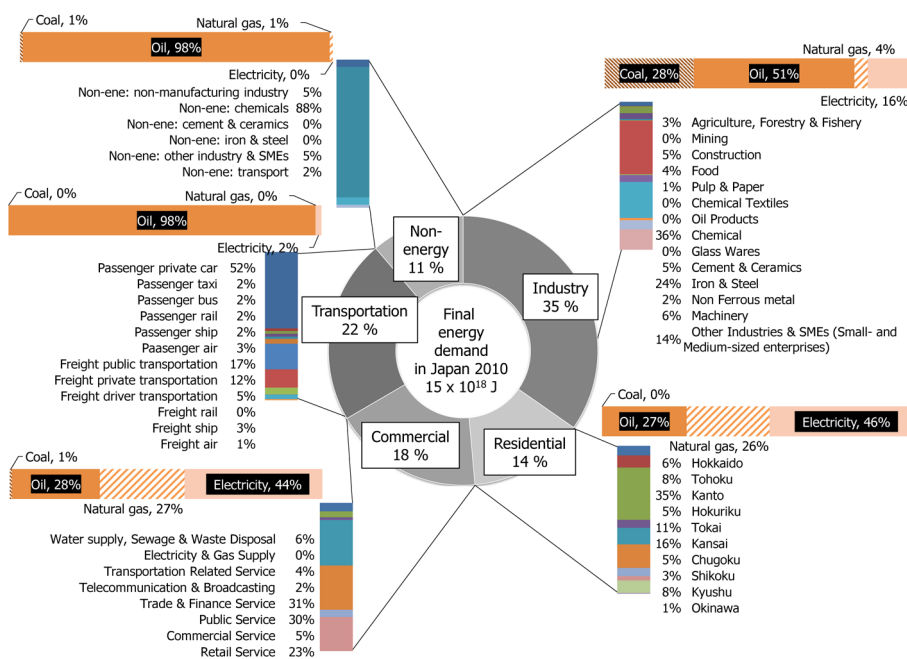

Fig. 4 Final energy demand of Japan in FY2010 based on comprehensive energy statistics. The values are rounded, and thus the summation will not necessarily be equal to 100%

and thus the important measure for improving the energy security has been to diversify the type of energy resources and importing countries. The import of primary energy resources will remain the major and practical option to cover the energy consumption in Japan for the coming several decades.

Here, we note that 95% of GHG emissions in Japan, i.e. 1,191 Mt-CO₂ in FY2010, is contributed by CO₂ (GGIO, 2013). Because almost all of the CO₂ emissions are from the use of fossil fuel in energy utilization and chemical processes, fossil fuel saving can be regarded as a reduction in GHG emission.

1.3 Energy demand

The statistical overview of Japanese energy demand is summarized in **Figure 4**, referring to the comprehensive energy statistics of Japan (ANRE, 2012). The industrial sector has the largest contribution to the final energy demand, where chemical and iron & steel making industries are the top two sub-sectors; in other words, major basic-materials industries have large energy demands. Transportation accounts for 22% of the total energy demand, where oils are mainly utilized. Contrary to the industrial and transportation sectors where fossil fuels and their derivatives were directly used, commercial and residential sectors require a higher ratio of electricity. In the residential sector, the

Kanto, Kansai, and Tokai regions have the top-three demands in Japan, because there are populated cities in each region: Tokyo, Osaka, and Nagoya, respectively. Non-energy use of resources is also incorporated in **Figure 4**. The 11% of the final energy demand is used as chemicals, such as solvents, lubricants and plastics.

The people in Japan have become aware of the temporal change of the electricity demand after 3.11 because the electricity supply capacity shortage during the peak demand period in the summer and winter was widely discussed. Japan's electric power grid is mainly organized by 10 companies: Hokkaido, Tohoku, Tokyo, Chubu, Hokuriku, Kansai, Chugoku, Shikoku, Kyushu, and Okinawa EPCO's. EPCO's except for Okinawa have now publicized the electricity demand data of their covering regions (see **Figure 5**). Depending on the seasons, weather, and regions, the daily demand curve shows different tendency. Most of the regions have a maximum peak power demand during the daytime of hot summer days. Companies covering the cold regions have peak demand in the morning or the evening of cold days in the winter. Those changing electric power demands must be timely supplied by managing facilities and load following properties of electric power generation systems to avoid quality fluctuation in electricity or the unscheduled power outages.

1.4 Supply of city gas, oils, and liquefied petroleum gas

Figure 6 shows the liquefied natural gas (LNG) terminals and major pipelines in Japan. In the event of the great earthquake, city gas supplies were stopped in many regions affected by the tsunami. Among the affected regions, Sendai was affected the most in terms of the number of households. It took more than one month to recover the city gas supply to the pre-earthquake level in Sendai except for the destroyed

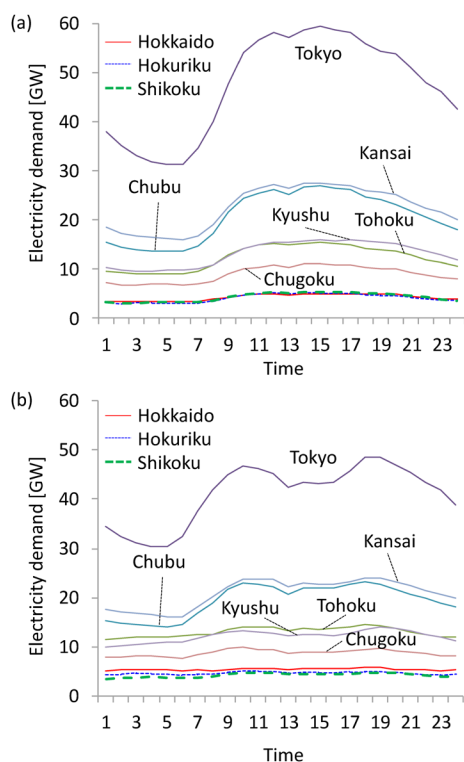

Fig. 5 Typical daily electricity demand profiles in Japan; average of three peak demands in (a) summer and (b) winter based on published data from nine EPCO's (Chubu-EPCO, 2013; Chugoku-EPCO, 2013; HEPSCO, 2013; Hokuriku-EPCO, 2013; KEPCO, 2013; Kyushu-EPCO, 2013; Shikoku-EPCO, 2013; Tohoku-EPCO, 2013; TEPCO 2013)

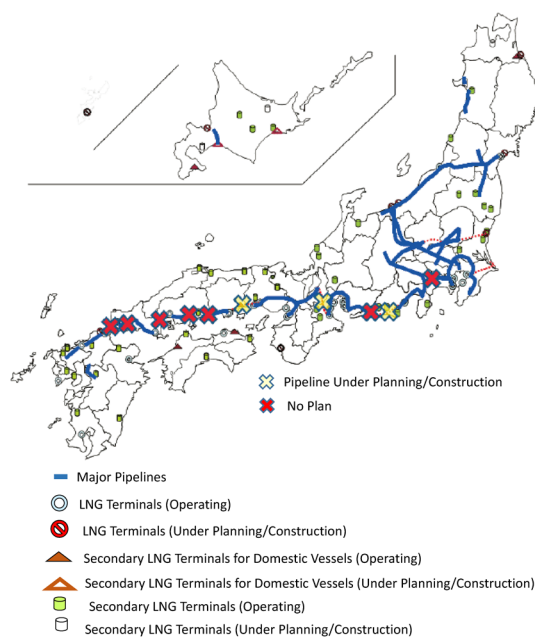

Fig. 6 LNG terminals and major pipelines in Japan (METI, 2012)

houses. This could be regarded as a quick recovery considering the situation that the LNG terminal of Sendai city gas had been fully destroyed. However, this could be regarded as a slow recovery considering the lives of people staying there. Therefore, the discussion of the resilience from the disaster has become active even in the context of energy systems. As can be seen from Figure 6, the areas covered by pipelines are still limited in Japan. Further, the existing pipelines are not well interconnected. To have access to multiple LNG terminals is desirable in terms of resilience from the disaster. Therefore, a wide-area gas pipeline infrastructure is being discussed seriously.

Like the LNG terminals, refineries are located near the sea shore, and thus some were also influenced by the tsunami. The supply of oils including gasoline, heating oil and light diesel oil depends on tanker lorry, railways, and vessels. Although the importance of their supply chains was not recognized explicitly before 3.11, the discussion from this aspect has been started considering the resilience from the disaster.

1.5 Electric power transmission grid

Figure 7 shows a schematic of Japan's centralized electric power grid infrastructure by nine major EPCO's. The Japanese electric power transmission grid is often called a prod structure against the mesh structure grid in Europe or the United States. Further, one can see that there are two different electricity frequencies in Japan. The eastern network consisting of Hokkaido, Tohoku and Tokyo EPCO's have introduced 50 Hz system, the western EPCO's including Okinawa, which is not connected with other companies due to its geological location, have adopted 60 Hz. The interchanges of electric power between companies in August 2013, which is scheduled as a result of the coordination by the Electric Power System Council of Japan, are also shown in the figure together with the estimated maximum summer electricity demand of each company.

The electricity grid was originally designed for each company to take responsibility for the secure supply to the consumer demands in its managing area, and thus the interchange capacities between companies are not well-developed in Japan, though the interconnection has been gradually strengthened between companies. The interchange

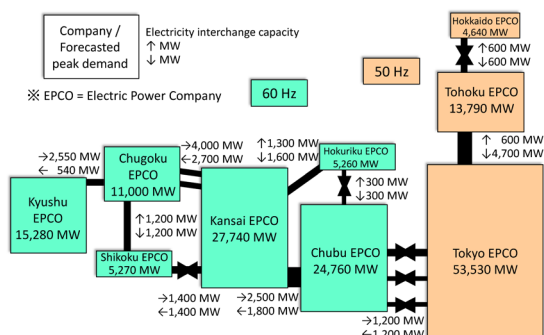

Fig. 7 Japan's electric power transmission grid with interchange capacities of electricity (Electric Power System Council of Japan, 2013)

capacity within the same frequency network is constrained usually by four factors: thermal capacity of transmission wire, voltage stability, frequency stability, and grid stability. Thermal capacity is set to avoid the wire burn out disconnection to the Joule heat. Voltage and frequency must be within the allowances defined by the law. Grid stability is important to avoid the loss of synchronism in the case of sudden disturbances such as troubles. Further, transmission between different frequency networks requires AC-DC conversion. Therefore, ca. 1 GW is the maximum interchange capacity between 50 Hz and 60 Hz networks. The interconnection of Hokkaido with Tohoku and Tokyo should also be noted that it is limited because its interconnection presently depends on AC-DC conversion, although those companies are adopting the same frequency.

1.6 Energy conversion technologies

1.6.1 Thermal power generation Thermal power generation is one of the most important options to generate electricity in Japan. To best utilize valuable imported fossil fuels, the conversion efficiency of the thermal power plants must be improved. Four types of thermal power plants are operating; 1) steam turbine (ST) power plant, 2) single cycle gas turbine power plant, 3) gas turbine combined with steam turbine cycle (GTCC) power plant, and 4) diesel power plant. The total capacity of thermal power plants including both utility and non-utility power generation is 182.4 GW as of the end of FY2010 and 771.3 TWh were generated in FY2010. The main components of the ST cycle are the steam boiler and steam turbine, and various fossil fuels such as coal, heavy-oil, diesel-oil and LNG are used to produce steam. Single-cycle gas turbine power plants were used for the centralized power generation due to its rapid start-up properties. Presently, it is not a popular option due to its lower efficiency compared with GTCC and the majority has been upgraded to GTCC. GTCC consists of a gas turbine, exhaust heat recovery boiler and steam turbine, and LNG is used as a fuel. Diesel power plants are used for isolated areas such as islands distant from the main islands of Japan. Therefore, the main thermal power plants in Japan are ST

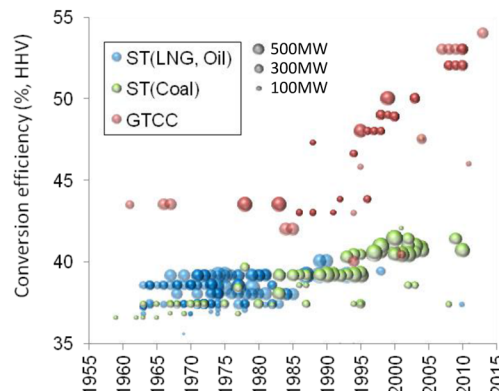

Fig. 8 Efficiency of newly-introduced thermal power generation (Thermal and Nuclear Power Engineering Society, 2008, cross-checked by other published data)

and GTCC.

Figure 8 shows the efficiencies of ST and GTCC systems constituting the grid, together with their installation years. GTCC efficiency has started to increase since the 1990's in accordance with the realization of the increase in the turbine inlet temperature from 1,100°C to higher. In 2013, GTCCs with a 1,600°C class gas turbine have started operation with 54% conversion efficiency (HHV). The efficiency of the ST cycle was improved along with the development of ultra-super critical boiler in the 1980's. Thermal power plants located in the area affected by the earthquake and the tsunami were damaged, but have been recovered from the disaster except for the No. 2 line of Shin-sendai plant, which has been decommissioned in October 2011. Due to the easier

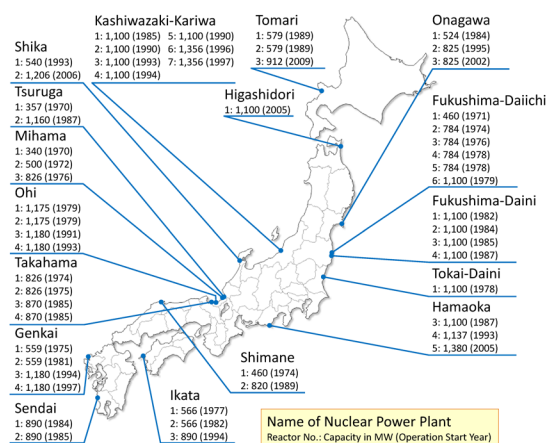

Fig. 9 Nuclear power plants in Japan before March 11, 2011, with their capacity and operation start years (The Federation of Electric Power Companies of Japan, 2011)

public acceptance compared with nuclear power plants, we do not need to consider the upper limit of the installed capacity for thermal power plants practically.

1.6.2 Nuclear power generation Nuclear power plants supplied 288.2TWh in FY2010, which is more than one fourth of the total electricity demand in Japan. Before the nuclear power plant failure associated with the great earthquake, the total supply capacity was 49GW (see **Figure 9**).

Two types of nuclear power plants are presently operating. One is a pressurized water reactor, and the other is a boiling water reactor. From the middle of the 1990's, advanced boiling water reactor plants were developed. In **Figure 9**, the reactors over 1.2GW, i.e. Hamaoka No. 5 and Shika No. 2 reactors, are the advanced boiling water reactor.

At the event of the 3.11 earthquake, reactor Nos. 1–4 of Fukushima-Daiichi were damaged and the decommissioning of those reactors was legally decided in April 2012, followed by the decommissioning of the reactor Nos. 5 and 6 in January 2014. Considering the situation that Japan is still facing the difficulty in restarting the nuclear power plants as of March 2014, it will be less probable to newly install nuclear power plants. Thus, the capacity of nuclear power plants in Japan will decrease, though we admit that there still remain controversial issues such as the life extension of the existing plants and the plants under construction at the event of 3.11.

1.6.3 Hydropower generation Hydropower was a main option to generate electricity until the 1960's in Japan. The capacity of hydropower plants has increased along with the economic growth of the country and total capacity of hydropower plants reached 48.1GW in FY2010 as shown in **Table 1**. Among the total capacity, 25.9GW is that of pumped hydroelectric power plants (The Federation of Elec-

Table 1 Current status and potential of energy resources for electricity generation

	Current status (March 2011)		Introduction potential		Capacity utilization ratio
	Capacity [GW]	TWh	Capacity [GW]	TWh	
Thermal	182.4	771.3	N/A	N/A	N/A
Nuclear	49.0	288.2	N/A	N/A	N/A
Hydro	48.1	90.7	17.9	N/A	N/A
Solar (Residential)	3.0	NA	13.8–193.6	14.5–203.5	
(Non Residential Total)	0.6		25.3–359.5	26.6–377.9	
Commercial buildings	N/A	N/A	0.8–23.9	0.8–25.1	
Public buildings	N/A	N/A	1.6–45.7	1.7–48.0	12%
Industrial buildings	N/A	N/A	17.5–96.6	18.4–101.5	
Unused, low utilization land	N/A	N/A	2.3–79.8	2.4–83.9	
Deserted cultivated land	N/A	N/A	3.1–113.5	3.3–119.3	
Wind power (Onshore)	2.3	4.0	65.2–1546.2	114.2–2708.9	20%
(Offshore Total)	N/A	N/A	68.2–2038.9	179.2–5358.2	
Fixed-bottom offshore wind turbine	N/A	N/A	29.5–368.4	51.7–645.4	30%
Floating type wind turbine	N/A	N/A	38.7–1670.5	67.8–2926.7	
Geothermal	0.5	2.6	2.2–23.6	15.4–165.2	80%
Biomass	1.95	N/A	N/A	15.3	N/A
Woody biomass	N/A	N/A	N/A	5.1	20%*
Methane production	N/A	N/A	N/A	10.2	45%*

* Thermal efficiency (HHV)

tric Power Companies of Japan, 2011), which are the main focus of development in the most recent couple of decades. Therefore, the total power generation was 90.7 TWh in FY2010, which is less than that expected from the total capacity.

Hydropower is an important option as a renewable energy. Presently, only small and intermediate sized sites are the remaining sites for potential development. The potential capacity and annual electric power generation from the viewpoints of economic and technological feasibilities are estimated to be 17.9GW and 7.3 TWh, respectively (METI, 2008; The Federation of Electric Power Companies of Japan, 2011). Development of small and intermediate size hydropower with a capacity less than 30MW is targeted in the scheme of feed-in tariff (FIT) that started in July, 2012. **Table 2** shows the status of the installed capacities of renewable options targeted in the FIT. Due to the longer lead time of hydropower plants, its registration is still limited.

1.6.4 Solar photovoltaic (PV) power generation Regarding solar energy utilization, PV has been popular and the thermal utilization is limited in Japan. PV power generation systems have been introduced gradually under the renewable portfolio standard regulation started in 2002 in Japan. As shown in Table 2, the total capacity of PV systems was ca. 5.6GW at the end of June 2012, just before the FIT started. PV systems have been registered for FIT and actually have been introduced the most due to much shorter lead time compared to the other options.

The introduction potential for PV is controversial. Table 1 shows the minimum and maximum introduction potentials of PV systems considering theoretical, physical, geological, and technological feasibilities, estimated by several organizations and companies (Photovoltaic Power Generation Technology Research Association, 2001; NEDO, 2009; EX Corporation *et al.*, 2010, 2011; Mizuho Information & Research Institute, 2011). Note that some analyses consider the economic feasibility in some ways. The total introduction potential of PV is 39.1 to 553.1GW by the summation of a variety of potential installation sites. Residential houses including apartments account for a considerable portion of the total introduction potential. Among the non-residential sites, 19.9–166.2GW is explained by commercial, public, and industrial buildings. Together with residential houses, the introduction potentials of buildings sum up to 33.7–359.8GW and the remaining is unused/low utilization, and deserted cultivated land areas. This is because Japan is

densely populated, and thus thinly populated or unutilized land areas are limited, compared with many other countries.

The potential amount of power generation from PV can be estimated by using the capacity utilization ratio of 12% (CVC, 2011). PV systems will potentially supply electric power of 41.1–581.4TWh.

1.6.5 Wind power generation Although the capacity of wind power has been increasing rapidly in the world, the installed capacity in Japan was ca. 2.6GW before FIT started. Even after the FIT enforcement, the registration and introduction are limited as shown in Table 2 due to its long lead time. On the contrary, a rich introduction potential is pointed out as can be seen from Table 1 (JWPA, 2010; Saito, 2010, 2011; EX Corporation *et al.*, 2010, 2011; Itochu Techno-Solutions Corporation, 2011). The introduction potential of onshore wind power generation systems is estimated to be 65.2–1,546.2GW. The lowest estimate is assuming the restriction of installation by the grid connection capacity before 3.11. This corresponds to 114.2–2,708.9TWh when we assume the capacity utilization ratio of 20% (CVC, 2011). The introduction potential of offshore wind systems competes with that onshore; i.e. 68.2–2,038.9GW. On the other hand, the expected electricity generation from offshore far exceeds that of onshore because of its higher capacity utilization ratio of 30% (CVC, 2011). There are two types of offshore wind systems: fixed-bottom and the floating types. Because the former is suitable for areas shallower than 50 m, the feasible sites could be constrained by the fishery industries, for example. Therefore, the floating type wind turbine is expected to be promising even though the technology is not mature compared with the fixed-bottom.

1.6.6 Geothermal power generation Japan is rich in geothermal resources. Geothermal utilization for electric power generation started in the 1960's, and plant developments continued until the middle of the 1990's. The installed capacity of geothermal power plants is, however, limited to ca. 0.5GW partly because the resource rich sites are located at hot spring towns or national parks. Like the wind, much registration and installation does not occur under the FIT scheme due to its long lead time as shown in Table 2, though geothermal is attracting much attention. The introduction potential of geothermal is estimated to be 2.2–23.6GW (see Table 1) (EX Corporation *et al.*, 2010, 2011). Exclusion of national park as installation sites gives 2.2GW, while its inclusion leads to 23.6GW. Traditionally, new installation of geothermal plants in national parks was prohibited; how-

Table 2 State of renewable options under the FIT scheme (METI, 2013)

	Before June 2012	July 2012 to June 2013	Total registration for FIT
PV (Residential)	ca. 4,700 MW	1,379 MW	1,633 MW
PV (Non residential)	ca. 900 MW	1,996 MW	19,755 MW
Wind	ca. 2,600 MW	66 MW	805 MW
Small hydro	ca. 9,600 MW	2 MW	79 MW
Biomass	ca. 2,300 MW	97 MW	639 MW
Geothermal	ca. 500 MW	1 MW	4 MW
Total	ca. 20,600 MW	3,540 MW	22,914 MW

ever, this is de-regulated so as to promote the installation of geothermal power plants in Japan. One of the advantages of geothermal is its high capacity utilization ratio compared to other renewable options. The high ratio of 80% (CVC, 2011) gives a stable electricity supply of 15.4–165.2 TWh.

1.6.7 Biomass power generation Biomass is a resource covering diverse materials such as wood, fallen leaves, sewage, livestock excretion, and agricultural crops. As of March 2011, 1.95 GW biomass power plants have been installed (see Table 1). Seventy five percent of those plants are waste and black-liquor power generations. Biomass power generation is usually based on mixed-combustion; coal or heavy oil is mixed with biomass to achieve a higher thermal efficiency. Thus, the biomass explains the 11.5% of input heat for power generation in FY2010. Iuchi (2004) conducted a potential assessment for 26 types of biomass. The biomass could be classified into two categories: those usable only for combustion and usable for methane production. The potential of biomass usable only for combustion was estimated to be 91.2 PJ, corresponding to 5.1 TWh of electricity when the thermal efficiency is 20% (CVC, 2011). The potential of methane production was estimated to be 81.6 PJ, corresponding to 10.2 TWh of electricity when the thermal efficiency of 45% by gas engine technology is assumed (CVC, 2011). Thus, the potential of biomass sums up to 15.3 TWh in Table 1.

2. Points of Discussion

2.1 Near term target

As a start, we will summarize the present trends and near-term targets organized by local governments, which will be an initial condition to discuss the long-term targets. Because the contribution of nuclear power plants is limited after March 11, 2011 in Japan, the role of thermal power plants has increased. While the safety of nuclear is still controversial as of March 2014, the increased role of thermal power plants in EPCO's is not favorable in terms of environment, economic efficiency, and energy security. From this aspect, the increased role of renewable resources, the efficiency increase of the thermal power plants, and the energy savings at the demand side are the important measures. Also, the CO₂ capture and storage (CCS) could be considered as a suboptimum future option to reduce the CO₂ emissions, sacrificing energy conversion efficiency. The concept of resilience against severe disasters or accidents is not yet fixed; however, one consensus on better resilience in the context of energy could be access to multiple sources. Examples will cover distributed energy systems and vehicle-to-home power supply.

The direction of Japan's energy policy is not yet fixed as of March 2014, and the controversy will continue even after approval by the government, however, one noticeable change after March 11, 2011 is the energy policies initiated by the local government, which are possibly because of the social recognition of demand-side energy measures as important options. Examples of energy strategies by the local

governments are Yamagata prefecture (2012), Nagano prefecture (2013), and Osaka prefecture & city (2013). Another example is the proposal of energy strategy for Fukuoka city organized by its advisory council (2013). The proposal summarized the practical demand side measures emphasizing three aspects; i.e. the promotion of energy savings, the utilization of the distributed energy systems such as renewable technology systems, and the area management of the energy.

In the following, we will discuss the demand-side options and their associated issues as well as the options of the centralized electric power grid.

2.2 Large-scale penetration of unadjustable renewable options

Renewable energy technologies can be classified into adjustable and unadjustable ones. Typical examples of the former are geothermal and hydro power generations and the latter options are PV and wind power. As unadjustable renewable power generation technologies are introduced on a larger scale, the control of electric power quality becomes difficult. More specifically, EPCO's in Japan have to keep the frequency of the grid within the allowance of 0.2 Hz, except for the Hokkaido where the allowance is 0.3 Hz. The frequency increases when the supply from power generation exceeds the power demand and vice versa. It is therefore necessary to adjust the output of power generation systems connected to the grid as well as to best estimate the power demand that also changes with time. As one of countermeasures to avoid the frequency control difficulty associated with the unadjustable renewable increase, upper limits of the grid connection are set by EPCO's for both PV and wind power. The near term target to increase the penetration of PV and wind power is to increase the upper limit by developing an advanced quality control method, such as a wide-area solar irradiation forecasting method and disconnection of the system from the grid during a certain period of the year.

When we assume further drastic penetration of unadjustable renewable technology, we are to face a totally different issue. Here, we discuss the issue by assuming a future situation when PV systems have been introduced on a large scale meeting 30% of the annual electricity demand in kWh. **Figure 10** is a simple schematic illustration of the electricity demand on a sunny summer day with large penetration of PV systems. The dark blue line in the figure represents the hypothetical electricity demand on a day in the future. When PV systems supply 30% of the annual electricity demand in kWh, the amount of electricity generated on a sunny day shown by the red line in this figure largely exceeds the peak demand of the day. This is because PV systems do not generate electricity at night or on rainy days. If we assume an extreme situation where the PV generates electricity without any storage measures, the profile shown by the light blue line in the figure is for the EPCO. Here, the cases of 10 and 20% PV supply to the annual electricity demand are also shown for comparison. If we stick to the present discipline that the EPCO's solely take the responsibility for a stable

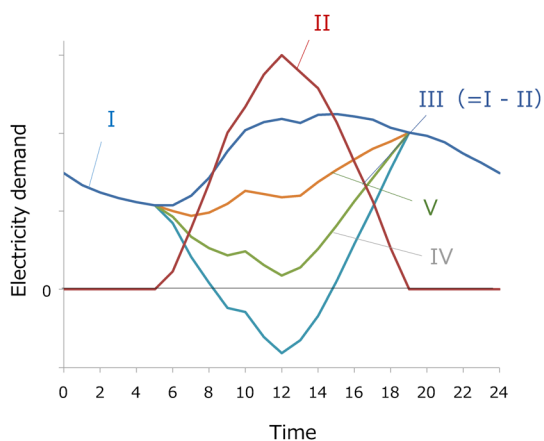

Fig. 10 Schematic of electricity demand on a future sunny day with large-scale penetration of PV systems. I: hypothetical future electricity demand of a day, II: electricity generated by PV assuming PV supplies 30% of annual electricity demand, III: a supply need for the centralized grid calculated by subtracting II from I, IV: a supply need assuming 20% supply of annual demand by PV, V: a supply need assuming 10% supply of annual demand by PV

electricity supply, it may lead to the traditional attitude to set a cap on the grid connection of PV and wind, which will hinder the drastic introduction of those technologies. From Figure 10, it is apparent that certain measures to bridge the gaps between supply and demand are necessary such as storage or advanced energy management. A new paradigm should be seriously sought to establish the required technologies and the framework to accommodate a considerable amount of unadjustable PV and wind systems, realizing grid stability simultaneously. We would like to point out that the time when we will face this issue in Japan is not far in the future because favorable places for installing photovoltaic and wind power generation systems are abundant in Hokkaido, Tohoku, and Kyushu regions of Japan where the demands are relatively small due to the smaller populations. Such a spatial gap between resource rich areas and energy-consuming areas should also be considered.

2.3 Demand side measures in residential, commercial, and industrial sectors

As mentioned in Section 2.2, discussion of the demand side measures is important from at least two aspects; i.e. the energy saving and the demand-side management of energy use. Energy saving is important in the near term to avoid the excess use of fossil fuels after 3.11 due to the limited operation of nuclear plants. The meaning of energy saving will be different in the context of long term perspective. Japan is expecting a decline in population, with an estimate being from the present 127.8 million to 97 million by 2050 (Ministry of Internal Affairs and Communications, 2013). To roughly estimate the energy consumption in the future, here we assume that the energy consumption can be expressed by (population) \times (per capita consumption). It is apparent that the energy consumption will decrease in 2050 by ca. 25% if

per capita consumption is constant. To see the effect of per capita consumption, here we assume steady changes in per capita consumption of -1.0 , -0.5 , $+0.5$, and $+1.0\%/yr$. A rough estimation gives us changes in energy consumption by ca. -50% , -40% , -10% , and $+10\%$ including population decline. It is apparent that the reduction in per capita consumption will have a significant impact. Although one may claim that the continuous reduction for several decades will not be realistic, one hope is that Japan is now oversaturated with functions and amenities, including air conditioners, televisions and refrigerators, and recently, the electricity consumption per household has nearly stabilized over the past decade.

The demand-side energy management is intensively discussed to realize the smart use of energy. Traditionally, EPCO's manage electricity systems and electricity consumers have been totally unaware of the supply-side management. If the consumers cooperate for the management, the energy efficiency can be improved and the total cost could become cheaper, for example, by shifting the energy consumption from the peak demand time to a smaller demand time of the day or the week. Adjustable energy consumption, such as air-conditioning, cooling, charging battery, and hydrogen production in the future, are candidate measures to bridge the demand by the consumers and the fluctuating supply from unadjustable PV and wind systems. These efforts can be presently found under the keywords of energy management system and demand response. The implementations of those combined with the decentralized energy system can play important roles not only in terms of efficient energy use but also the large-scale penetration of unadjustable renewable systems.

2.3.1 Energy use in residential and commercial sectors Space heating and hot water supply account for the largest part of energy consumption in residential and commercial sectors: 57% and 43%, respectively (IEEJ, 2012). Electric appliances such as refrigerators, lighting, television and electronic devices occupy the majority of the remaining energy consumption in those sectors.

Gas and oil are usually used in stoves or boilers directly for space heating and hot water supply. The efficiency of the latest gas-fired boiler reaches around 95% in HHV (JGA, 2013a); therefore, little room remains for a further efficiency improvement. Electricity consumption for space heating and cooling is mainly explained by the use of air conditioners based on heat-pump technology. Heat-pumps can be regarded as the most innovative technology to save energy for those services during the last decade (Chua *et al.*, 2010). The COP of air conditioners in residential sectors has been improved over the last decades as shown in **Figure 11**. We can see that the COP reached over 4 in 2007. The COP value of 4 means that 4 units of thermal energy are available by using a unit of electricity. Thus, thermal energy larger than that of original fossil fuel energy is available even considering the electric power conversion efficiency of thermal power plants when we can properly use the heat pump. Note that heat pump technology can be applied for water heating with the

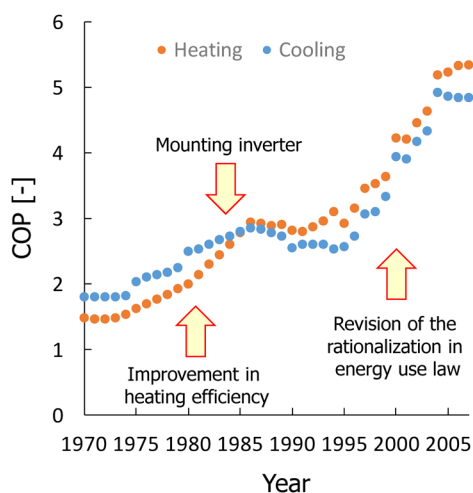

Fig. 11 Trend of COP of heat pump system for air conditioning in residential sector (Japan Center for Climate Change Actions, 2007)

COP of 3–4 presently. Therefore, the use of advanced heat pumps will play a key role to drastically save energy used for space heating, cooling and hot water supply.

Residential cogeneration systems based on fuel cell technologies are emerging in Japan. Polymer electrolyte fuel cell based systems were commercialized in May 2009 followed by the commercialization of solid oxide fuel cell (SOFC) based system in October 2011. Fuel cell based residential cogeneration systems are denoted as Ene-Farm, a common name in Japan. Its installation has gradually increased along with a strong need for decentralized systems after 3.11 as shown in Figure 12. Ene-Farm can save energy for residential use because it co-generates electricity and heat with respective conversion efficiencies of 36–42% and 39–45% in HHV (JGA, 2013a). One important advantage of Ene-Farm is the better heat to power ratio compared to conventional co-generation systems such as gas engine and gas turbine, realizing a large energy saving compared with the conventional systems. Further improvement of electricity conversion efficiency is expected, which will drive the penetration of Ene-Farm into not only residential, but also commercial and business buildings.

In summary, the heat pump and the small-sized cogeneration technologies as well as ultra-low energy consuming electric appliances will be key technologies to realize drastic energy savings in residential and commercial sectors.

The development target of the heat pump technology will be a novel refrigerant for further penetration and COP improvement (Chua *et al.*, 2010), as well as improvements in performance in cold regions where the products' COP for those regions is currently significantly lower. Figure 13 shows the estimation of the relative COP of heat pumps in different temperature conditions, estimated on the basis of the work by Ueno and Kitahara (2011). We can clearly see that the COP will decrease drastically when the heat pump is used in a cold region where the ambient temperature falls below zero. Defrost of the outdoor unit of the heat pump is

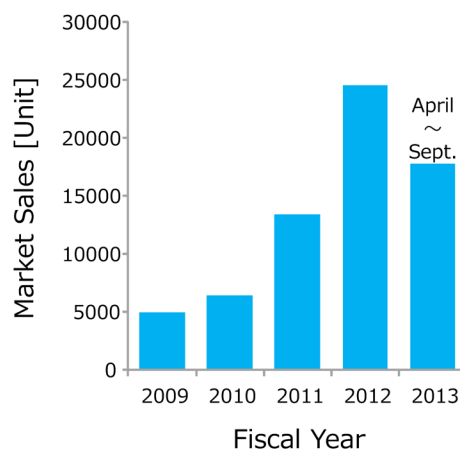

Fig. 12 Installation of residential fuel cell systems (Advanced Cogeneration and Energy Utilization Center Japan, 2013)

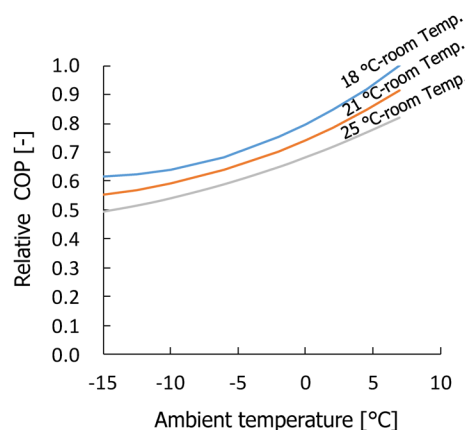

Fig. 13 Estimated relative COP of room heating. The reference is the condition that the ambient and the room temperatures are 7 and 18°C, respectively

noted as an additional factor for the reduced practical COP (Ueno and Kitahara, 2012). Therefore, the improved COP for the use in cold conditions is an important target.

Cost reduction and durability are the most prioritized development targets of fuel cell systems, followed by an electrical conversion efficiency improvement to compete with the advanced thermal power generation systems of the grid (NEDO, 2010; personal communications with developers).

The efficiency of refrigerators has been improved over the last decade due to the good insulation panels and inverter control technologies (Ikeboh, 2012). Further improvement will depend on, for example, low friction compressors (Ichimoto, 2010). The lighting efficiency has also improved recently by the use of light-emitting diodes. Cost reduction as well as further efficiency improvement are important. The realization of technologies such as ultra-low energy consuming electric appliances (JST, 2010, 2012) and high-efficiency AC-DC converters are important.

In addition to the above mentioned technologies, the introduction of energy management systems as well as novel building design such as better insulation (Japan Center for

Climate Change Actions, 2006) or space arrangement will be important for the better use of energy.

2.3.2 Energy use in industrial sector The industrial sector requires various energy resources for diverse purposes. Energy is used to meet demands specific to each industry such as high-temperature and pressure thermal energy and high-quality electricity for accurate processing. The characteristics of energy demand such as heat-to-power ratio and daily profile strongly depend on each industry. Decentralized power plants are installed in many industrial factories to meet such demand by themselves, simultaneously meeting other purposes such as economic efficiency and operation security against grid blackout risks due to, for example, the lightning weather. For a further improvement, energy symbiosis will be an important and effective future option (Chertow and Ehrenfeld, 2012). An example of energy symbiosis is the integrated energy supply system for multiple sites with different demand characteristics such as those between different industries. Such integration of different demand characteristics may lead to a better match with the heat to power ratio of a decentralized energy system, better heat management in terms of exergy, etc. For facilitating energy symbiosis, understanding the present picture of actual heat and power demands is important for designing an integrated energy use between different demand sites.

Fossil fuel resources as materials are also important for base material industries. The use of materials is mainly classified into two types: process chemical and raw material. The former does not compose final products, but are used to fulfill specific functions within production processes as solvents, catalysts, reduction agents, etc. to convert raw materials to products. The latter is literally used and usually composes the final products.

Some major possible options in the industrial sector are the replacement of the existing aged facilities and the installation of non-conventional technologies. The facility replacement includes advanced thermal management such as combined heat and power production, exergy recuperation, rapid heat transfer or exchange, and the integration of different processes. Those will lead to energy savings in industry. When we aim at a further drastic reduction in the CO₂ emissions from the industrial sector, we need to reduce the CO₂ emission associated with all fossil resource uses in the industry. Because it will be difficult to replace the fossil resource used in industry by renewable energy considering the quality and the reliability of energy needs and the nature of the use as materials, we may need non-conventional technologies such as CCS and the production of chemicals from renewable resources. The former is a possible measure to reduce CO₂ emissions from the decentralized energy system, while its installation is associated with the excess use of fossil fuels and may induce controversy. Examples of the latter will be technologies to produce valuable chemicals from biomass or renewable electricity.

2.4 Measures in transportation sector

The total energy consumption in the transportation sector

is 22% of Japanese energy demand in FY2010 from Figure 4. Eighty-nine percent of energy consumption in the transportation sector is by automobiles, 2% by railway, 5% by shipping, and 4% by aviation. Ninety-eight percent of the demand is covered by oil and the remaining is by electricity, which is mainly used for railways. Passenger cars occupy 52% out of the 89% total automobile energy consumption. Diesel freight vehicles (28%) and gasoline freight vehicles (10%) follow passenger cars, and the remaining are taxis and buses. It makes us first focus on the passenger cars for a CO₂ emission reduction in the transportation sector.

A variety of options are discussed for this purpose (Daisho, 2008, 2011; MoE, 2010), which could be classified into: 1) fuel consumption improvement of conventional vehicles and penetration of next generation vehicles, 2) use of low carbon fuel, 3) low carbon use of vehicles and 4) traffic flow improvement, which are described more specifically in the following.

Examples of the fuel consumption improvements of conventional vehicles are the improvement of engines, the use of light materials, a reduction in auxiliary system losses, improvement in drive systems and driving resistance reductions such as frictional and air resistances. Daisho (2011) has quantitatively evaluated mileage improvements by a number of measures such as direct injection systems for internal combustion engines and continuously variable transmissions. The Japanese government has set a target for car manufacturers to achieve, for promoting a fuel consumption improvement, as well as support for research and development. Next generation vehicles include battery electric vehicles (BEV), fuel cell vehicles (FCV), hybrid electric vehicles (HEV) and plug-in hybrid electric vehicles (PHEV). Their improved mileages are evaluated in terms of tank to wheel efficiency against a standard five-passenger 1,500cc class internal combustion engine vehicle (ICEV) (JARI, 2011). The energy consumption of BEV, FCV, and HEV are evaluated to be 24%, 43%, and 63%, respectively, compared with ICEV. PHEV ranges between 25 and 67%, depending on the driving mode.

Examples of low carbon fuel are bio-derived fuels and natural gas. The contribution of the former measure is limited unless we assume bio-derived fuel production abroad, due to the limited land area of Japan. According to an estimation carried out by Ministry of Agriculture, Forestry and Fisheries (MAFF), the potential of domestic bio-derived fuel production in 2030 is 6 billion L or 0.13 EJ of ethanol equivalent (MAFF, 2007). This is less than 5% of the energy consumption of automobiles in Japan. It is noted that the potential quantity of ethanol production by sugar, i.e. excluding rice and wheat straw that strongly affect food production, is 50 million L, less than 1% of the total biomass fuel. The use of compressed natural gas vehicles is not popular in Japan. According to the Japan Gas Association, 43.9% of the total 42,590 compressed natural gas vehicles are trucks (JGA, 2013b). The keys to its diffusion will be the cost reduction and refueling stations. Note that the hydrogen produced from renewable energy or from fossil fuels with

CCS technology can be future options as low-carbon fuels. To realize as a feasible system, we need to carefully discuss the technological and economic feasibilities of renewable-derived hydrogen assuming the future development of related technologies such as electrolysis, catalysis, CCS and infrastructure.

The low carbon use of vehicles includes measures such as eco-driving like idling stop, car sharing and the change of drivers' behavior.

Measures for traffic flow include a modal shift, the promotion of public transportation usage, and intelligent transportation systems for mitigating traffic jams.

It is concluded that the fuel consumption improvement of vehicles and the penetration of next generation vehicles are the most effective among the above four categories to reduce CO₂ emissions in 2020. The importance of next-generation vehicles is explicitly pointed out as an effective measure in both near and long terms. Therefore, the design of an infrastructure that can facilitate the next-generation vehicles is an important point of discussion. Also, the availability of key elements such as platinum used in next-generation vehicles should be carefully discussed.

2.5 Centralized electric power conversion and storage

The role of the centralized electric power system is the timely supply of the good quality electricity required by the consumers. For the coming decades, thermal power generation based on fossil fuel is expected to play a key role. It is thus important to improve the electric power conversion efficiency to reduce the use of fossil fuels as well as the CO₂ emission associated with its use.

Coal-fired power plants will improve efficiency by either increasing the boiler temperature or the use of the gasification process. The 42% HHV efficiency of the state of the art boiler operating at over 600°C is expected to reach 46% HHV by increasing the steam temperature up to over 700°C (Makino, 2012). Besides, the integrated coal gasification combined cycle (IGCC) consisting of gasification process, gas turbine, and steam turbine can achieve higher conversion efficiency depending on the inlet temperature of the gas turbine. IGCC is now in the final phase of demonstration and is being considered for installation in the Fukushima prefecture with the plan of operation start around 2020.

The efficiency improvement of natural gas fired thermal power generation depends on the inlet temperature of the gas turbine. Three GTCC's with the turbine inlet temperature of ca. 1,600°C are commercially operating as of March 2014 achieving the conversion efficiency of 54% HHV. Further improvement is presently targeted by increasing the turbine inlet temperature to 1,700°C, leading to the conversion efficiency of 57% HHV (Kobayashi *et al.*, 2011).

The efficiency improvement of fossil fuel usage in the centralized electric power conversion systems could be achieved by technologies different from the thermal cycles. The most promising and feasible technology will be fuel cell technology. Among the several types of fuel cells, SOFC is expected to match well with the centralized power generation

purpose. SOFC-based combined cycles will be an ultimate target (Koyama *et al.*, 2004; Kobayashi *et al.*, 2011; Makino, 2012). LNG-fueled SOFC combined cycles are expected to achieve the efficiency over 65% HHV in the future (Koyama *et al.*, 2004; Kobayashi *et al.*, 2011), while when SOFC is integrated with IGCC, the expected efficiency will reach over 54% ultimately (Makino, 2012). Though the SOFC-based combined cycle can achieve higher efficiency than the conventional thermal cycles, it still requires research and development, as well as advanced systems engineering such as high level system integration and the scaling up of the SOFC. Because the system operates at higher temperature and pressure, the durability of the SOFC will be different from that of residential SOFC working at lower temperature and ambient pressure. When integrated with coal gasification, the durability against minor impurity species in coal gas will become more significant (Kuramoto *et al.*, 2012).

When we target a carbon-neutral society, the CO₂ emissions from the use of fossil fuels must be avoided where possible. It is apparent that renewable energies are important in this context. To counter the fluctuating output from the unadjustable renewables, the thermal electric power generation plants will play an important role in stabilizing the frequency of the grid by their flexible output capabilities. There are thus two directions to reduce CO₂ emissions from the centralized grid keeping the adjustable capability: to use CCS technology and to use energy storage technologies to counter the fluctuating supply and demand gap. CCS can reduce the large fraction of CO₂ in the exhaust of thermal electric power plants sacrificing a certain energy efficiency of the plant. While CCS is proven to be technologically feasible under specific conditions for oil and gas fields and saline formations (IPCC, 2005), feasibility including social acceptance in Japan must be carefully discussed. The storage of electricity will be an important option to largely install renewable energy keeping a grid connection. The pumped storage hydroelectric plant is presently the most feasible option in Japan, while its increase will be limited. Sodium-sulfur batteries will be the second feasible option, possibly followed by the flow-battery. Note that other options including next generation technologies and recycling of used batteries should be carefully considered as future feasible options. When we assume the future condition hypothetically illustrated in Figure 10, chemical storage of renewable electricity can be a possible option when we consider its stability for the long-term storage. Note that chemical storage may play a role in bridging the spatial gap between the resource-rich and energy-consuming regions.

Conclusions

Energy is the base of all activities in a country, and thus constitutes an essential part of the nation's being. When we envision future energy systems, the important factors will specifically be the design of energy infrastructure considering the best use of the existing systems, the pursuit of saving exhaustible resources and energy usage, the environmental

preservation, and so on.

As discussed in Section 2.1, Japan has to challenge maximizing renewable energies, as well as minimizing the conventional exhaustible resources in the ultra-long term perspective, considering that Japan is not rich in conventional primary energy resources: i.e. fossil and nuclear fuels. Because rapid transition is unrealistic considering the lifetime of the energy infrastructure, conventional resources will keep their major roles in Japan's energy system, thereby making the energy savings at the demand sides more important.

The potential of renewable energy to be developed in Japan is expected to be larger in the order of wind, solar, and geothermal, though it is admitted that their feasibilities are still controversial. Because the electricity output from wind and solar are unadjustable, the advanced energy management and measures for electricity storage have to be implemented on a large scale. The advanced energy management will need a transition of paradigm, i.e. from management by the centralized energy suppliers to that considering both supply and demand sides possibly by utilizing the advanced information technologies. While the pumped hydro and batteries will be near-term feasible storage options, chemical storage can be considered seriously to bridge the extreme temporal and spatial gaps between the energy supply and demand. To cover the use of fossil resources as materials, the development of renewable chemicals will be necessary in the ultra-long perspective, which may also cover electricity, automobile fuel and fuel for distributed power generation systems in the industrial sector. The success of next generation vehicles is important to realize a drastic reduction in CO₂ emissions in the transportation sector. The most important option for the centralized electric power conversion sector will be an efficiency improvement in thermal power plants, considering the decreased role of nuclear. CCS can be another option, although its feasibility in Japan must be carefully considered.

Acknowledgements

The authors are grateful to Profs. Kuniaki Honda, Mark Paster, James Stubbins, Dr. Xuping Li, Ms. Motoko Yanagi, and Mr. Yoshitaka Okamoto for their fruitful discussions and support. The Committee on Future Energy and Social Systems, Center for Strategic Planning, the Society of Chemical Engineers, Japan is also highly acknowledged for discussions on future energy systems. The activities of INAMORI Frontier Research Center are supported by KYOCERA Corporation. The activities of Presidential Endowed Chair for "Platinum Society" in the University of Tokyo are supported by the KAITEKI Institute Incorporated, Nippon Telegraph and Telephone Corporation, FUJIFILM Holdings Corporation, Mitsui Fudosan Corporation, and LIXIL Corporation.

Literature Cited

Advanced Cogeneration and Energy Utilization Center Japan; <http://www.ace.or.jp/> (2013)
Agency for Natural Resources and Energy (ANRE), Ministry of Economy, Trade and Industry, Japan; "Table of the FY1990–FY2010

Comprehensive Energy Statistics," Agency for Natural Resources and Energy, Tokyo, Japan (2012)
Chertow, M. and J. Ehrenfeld; "Organizing Self-Organizing Systems: Toward a Theory of Industrial Symbiosis," *J. Ind. Ecol.*, **16**, 13–27 (2012)
Chua, K. J., S. K. Chou and W. M. Yang; "Advances in Heat Pump Systems: A Review," *Appl. Energy*, **87**, 3611–3624 (2010)
Chubu Electric Power Company (Chubu-EPCO); "Past Records of Power Demand," <https://www.chuden.co.jp/> (2013)
Chugoku Electric Power Company (Chugoku-EPCO); "Past Records of Power Demand," <https://www.chuden.co.jp/> (2013)
Cost Verification Committee (CVC), Cabinet Office, Government of Japan; "Report of the Cost Verification Committee (Kosuto tou kensho iinkai repohto)" (2011)
Daisho, Y.; "Perspectives on Future Motor Vehicle Technologies Associated with Environment and Energy," *IATSS Rev.*, **33**, 51–56 (2008)
Daisho, Y.; "Prospect on Environmental and Energy Vehicle Technologies," *NTN Technical Review*, **79**, 2–11 (2011)
Electric Power System Council of Japan ed.; "Operation Capacity Forecast of Interconnected Power System in FY2013 (Kaku chiiki kan renkei setsubi no unyo yoryo santei kekka—Heisei 25 nendo—)," Electric Power System Council of Japan, Tokyo, Japan (2013)
EX Corporation, Asia Air Survey Co., Ltd., Pacific Consultants Co., Ltd. and Itochu Techno-Solutions Corporation; "Study of Potential for the Introduction of Renewable Energy (FY2009)," Ministry of Environment, Tokyo, Japan (2010)
EX Corporation, Asia Air Survey Co., Ltd., Pacific Consultants Co., Ltd. and Itochu Techno-Solutions Corporation; "Study of Potential for the Introduction of Renewable Energy (FY2010)," Ministry of Environment, Tokyo, Japan (2011)
Fukushima, Y., M. Shimada, S. Kraines, M. Hirao and M. Koyama; "Scenarios of Solid Oxide Fuel Cell Introduction into Japanese Society," *J. Power Sources*, **131**, 327–339 (2004)
Fukushima, Y., Y. Kikuchi, Y. Kajikawa, M. Kubota, T. Nakagaki, M. Matsukata, Y. Kato and M. Koyama; "Tackling Power Outages in Japan: The Earthquake Compels a Swift Transformation of the Power Supply," *J. Chem. Eng. Japan*, **44**, 365–369 (2011)
Greenhouse Gas Inventory Office of Japan (GGIO); "The GHG Emissions Data of Japan (1990–2011)," National Institute for Environmental Studies, Tsukuba, Japan (2013)
Hokkaido Electric Power Company (HEPCO); "Past Records of Power Demand," <http://www.hepco.co.jp/> (2013)
Hokuriku Electric Power Company (Hokuriku-EPCO); "Past Records of Power Demand," <http://www.rikuden.co.jp/> (2013)
Ichimoto, K., H. Nakamura and R. Kawai; "More Convenience" Pursuit of Large Capacity and Energy-Saving for Refrigerators," *Hitachi Review*, **92**, 762–763 (2010)
Ikeboh, Y.; "The Latest Technology for Refrigerator," *Journal of the Institute of Electrical Engineers of Japan*, **132**, 539–541 (2012)
Intergovernmental Panel on Climate Change (IPCC); IPCC Special Report on Carbon Dioxide Capture and Storage, pp. 51–74, Cambridge University Press, Cambridge, U.K. (2005)
International Energy Agency (IEA); "Energy Technology Perspectives 2010," International Energy Agency, Paris, France (2010)
International Energy Agency (IEA); "2012 Key World Energy Statistics," International Energy Agency, Paris, France (2012)
Itochu Techno-Solutions Corporation ed.; FY2010 Report on Fundamental Survey on the Promotion of Introducing New Energies (The Study of Potential for the Introduction of Wind Energy) (Heisei 22 nendo Shin enerugi tou dounyu sokushin kiso tyousa jigyo (huryoku enerugi no dounyu kanouryo ni kansuru tyousa) tyousa hokokusyo, Ministry of Economy, Trade and Industry,

- Tokyo, Japan (2011)
- Iuchi, M.; "Development of the Support System for Biomass Energy Business Plans—The Data Base and Evaluation Models to Simulate the Collection Cost—," *CRIEPI Report*, Y03023 (2004)
- Japan Automobile Research Institute (JARI); Report of Analysis on Overall Efficiency and GHG Emissions (Sougou koritsu to GHG haisyutsu no bunseki houkokusyo), Tsukuba, Japan (2011)
- Japan Center for Climate Change Actions ed.; A Fact Sheet of Residences for Energy-Saving (Syō enerugi jutaku fakuto shihto), Japan Center for Climate Change Actions, Tokyo, Japan (2006)
- Japan Center for Climate Change Actions ed.; "A Fact Sheet of Home Electric Appliances for Energy-Saving (Syō enerugi kaden fakuto shihto)," Japan Center for Climate Change Actions, Tokyo, Japan (2007)
- Japan Gas Association (JGA); "Outline of Technology Development in City Gas Business (toshi gasu jigyo ni okeru gijutsukaihatsu no gaiyo)" <http://www.gas.or.jp/outline/technology/> (2013a)
- Japan Gas Association (JGA); "State of Dissemination in Japan (Nihon no fukyu jokyo)" http://www.gas.or.jp/ngvj/spread/jpn_spread.html (2013b)
- Japan Science and Technology Agency (JST); "Can Spintronics Go beyond Silicon Device? (supintononikusu ha sirikon debaisu wo koerareruka?)," *JST News*, 7, 6–9 (2010)
- Japan Science and Technology Agency (JST); "Energy Saving Device Breaking the Theoretical Barrier (Riron genkai wo toppasuru syoene debaisu)," *JST News*, 9, 8–11 (2012)
- Japan Wind Power Association (JWPA) ed.; "Available Resources and Potentials of Wind Power and the Calculation of Long-Term Introduction Target and Roadmap (Ver.1.1) (Huryoku hatsuden no fuzonryo to potensyaru oyobi koreni motodoku tyoki dounyu mokuhyo to ro-do mappu no santei)," Japan Wind Power Association, Tokyo, Japan (2010)
- Kansai Electric Power Company (KEPCO); "Past Records of Power Demand," <http://www.kepco.co.jp/> (2013)
- Kobayashi, Y., Y. Ando, T. Kabata, M. Nishiura, K. Tomida and N. Mataka; "Extremely High-Efficiency Thermal Power System-Solid Oxide Fuel Cell (SOFC) Triple Combined-Cycle System," *Mitsubishi Heavy Industries Technical Review*, 48, 9–15 (2011)
- Koyama, M., S. Kraines, K. Tanaka, D. Wallace, K. Yamada and H. Komiyama; "Integrated Model Framework for the Evaluation of an SOFC/GT System as a Centralized Power Source," *Int. J. Energy Res.*, 28, 13–30 (2004)
- Kuramoto, K., T. Fukushima, K. Matsuoka, Y. Suzuki, H. Kishimoto, K. Yamaji, T. Horita, M. E. Brito and H. Yokokawa; "Chemical Degradation Behavior of SOFC Anode Due to Trace Impurities of ppm Order Contained in a Coal Derived Syngas," *ECS Trans.*, 41, 81–90 (2012)
- Kyushu Electric Power Company (Kyushu-EPCO); "Past Records of Power Demand," <http://www.kyuden.co.jp/> (2013)
- Lawrence Livermore National Laboratory (LLNL) ed.; U.S. Energy Flow 2012, Lawrence Livermore National Laboratory, Livermore, U.S.A. (2013)
- Makino, K.; "Introduction of Up-to-Date Technology of High Efficient Pulverized Coal Fired Power Generation and Integrated Gasification Combined Cycle," *Journal of the Japan Institute of Energy*, 91, 570–575 (2012)
- Matsubae, K., J. Kajiyama, T. Hiraki and T. Nagasaka; "Virtual Phosphorus Ore Requirement of Japanese Economy," *Chemosphere*, 84, 767–772 (2011)
- McDowall, W. and M. Eames; "Forecasts, Scenarios, Visions, Backcasts and Roadmaps to the Hydrogen Economy: A Review of the Hydrogen Futures Literature," *Energy Policy*, 34, 1236–1250 (2006)
- Ministry of Agriculture; Forestry and Fisheries (MAFF); "Drastic Expansion of Domestic Biofuel Production (Kokusan baio nenryo no ohabana seisan kakudai)," MAFF, Tokyo, Japan (2007)
- Ministry of Economy, Trade and Industry (METI); Midterm Report for Hydro Power Generation (Suiryoku hatsuden ni kansuru kenkyukai chukan houkoku), METI, Tokyo, Japan (2008)
- Ministry of Economy, Trade and Industry (METI); 2011 Annual Report on Energy in Japan (Japan's Energy White Paper 2011), METI, Tokyo, Japan (2011a)
- Ministry of Economy, Trade and Industry (METI); Countermeasures for Electricity Demand-Supply Gap in Summer (Kaki no denryoku jukyu taisaku ni tsuite), METI, Tokyo, Japan (2011b)
- Ministry of Economy, Trade and Industry (METI); "News Release of Publication of Introduction Statuses of Renewable Power Generation Facilities as of June 30, 2013 (Saisei kanou enerugi hatsuden setsubi no dounyu jokyo wo kohyo shimasu (Heisei 25 nen 6 gatsu matsu jiten)), METI, Tokyo, Japan (2013)
- Ministry of Finance Japan (MOF); "Trade Statistics of Japan," http://www.customs.go.jp/toukei/info/index_e.htm (2013)
- Ministry of Internal Affairs and Communications of Japan ed.; Statistics of Japan 2013, Ministry of Internal Affairs and Communications of Japan, Tokyo, Japan (2013)
- Ministry of the Environment (MoE); Concrete Vision of Measures and Policies to Achieve Mid- and Long-Term Greenhouse Gas Reduction Target (Mid- and Long-Term Roadmap) (An Interim Report) (Chutyoki no onshitsukouka gasu sakugen mokuhyo wo jitsugen surutameno taisaku shisaku no gutaitekina sugata (Chutyoki ro-do mappu) (Chukan seiri)), MoE, Tokyo, Japan (2010)
- Mizuho Information & Research Institute; FY2010 Report on Fundamental Survey on the Promotion of Introducing New Energies (The Study of Potential for the Introduction of Photovoltaic Cell and Solar Thermal Energy) (Heisei 22 nendo Shin enerugi tou dounyu sokushin kiso tyousa jigyo (Taiyokou hatsuden oyobi taiyou netsu riyou no dounyu kanouryo ni kansuru tyosa)), Mizuho Information & Research Institute, Tokyo, Japan (2011)
- New Energy and Industrial Technology Development Organization (NEDO) ed.; Photovoltaic Cell Roadmap (PV2030+) (Taiyokou hatsuden ro-do mappu (PV2030+)), Kawasaki, Japan (2009)
- New Energy and Industrial Technology Development Organization (NEDO) ed.; Fuel Cell and Hydrogen Technology Development Roadmap 2010 (Nenryo denchi suiso gijutsu kaihatsu ro-do mappu 2010, Kawasaki, Japan (2010)
- Photovoltaic Power Generation Technology Research Association; Survey on the Evaluation of Photovoltaic Power Generation; (Taiyokou hatsuden hyouka no tyousa kenkyu), NEDO, Kawasaki, Japan (2001)
- Saito, T.; "Available Resources and Potentials of Wind Power—Long Term Target and Roadmap V2.1— (Huryoku hatsuden no fuzonryo to potensyaru—Tyoki dounyu mokuhyo to ro-do mappu V2.1—)," *JWPA*, Aug. 2010, 38–43 (2010)
- Saito, T.; "Available Resources and Potentials of Wind Power (Huryoku hatsuden no fuzonryo to potensyaru V3.0)," *JWPA*, Aug. 2011, 37–39 (2011)
- Shikoku Electric Power Company (Shikoku-EPCO); "Past Records of Power Demand," <http://www.yonden.co.jp/> (2013)
- The Federation of Electric Power Companies of Japan ed.; Handbook of Electric Power Industry 2011, the Japan Electric Association, Tokyo, Japan (2011)
- The Institute of Energy Economics; Japan (IEEJ) ed.; "EDMC Handbook of Energy & Economic Statistics in Japan 2012," the Energy Conservation Center, Japan, Tokyo, Japan (2012)
- Thermal and Nuclear Power Engineering Society ed.; Handbook of

Thermal and Nuclear Power Plants (Karyoku genshiryoku hatudensyo setsubi youran), Thermal and Nuclear Power Engineering Society, Tokyo, Japan (2008)

Tohoku Electric Power Company (Tohoku-EPCO); "Past Records of Power Demand," <http://www.tohoku-epco.co.jp/> (2013)

Tokyo Electric Power Company (TEPCO); "Past Records of Power Demand," <http://www.tepco.co.jp/index-j.html> (2013)

Ueno, T. and H. Kitahara; "Development of Heat Characteristic Model of Home User Air Conditioner—Part 3: Characteristics Model for Heating Period," *CRIEPI Report R10009* (2011)

Ueno, T. and H. Kitahara; "Development of Heat Characteristic Model of Home User Air Conditioner—Part 3: Characteristics Model for Heating Containing Defrost Period," *CRIEPI Report R11017* (2012)