

# Drawing graphs with *dot*

Emden Gansner and Eleftherios Koutsofios and Stephen North

January 26, 2006

## Abstract

*dot* draws directed graphs as hierarchies. It runs as a command line program, web visualization service, or with a compatible graphical interface. Its features include well-tuned layout algorithms for placing nodes and edge splines, edge labels, “record” shapes with “ports” for drawing data structures; cluster layouts; and an underlying file language for stream-oriented graph tools. Below is a reduced module dependency graph of an SML-NJ compiler that took 0.98 seconds of user time on a 1.4 Ghz AMD Athlon.

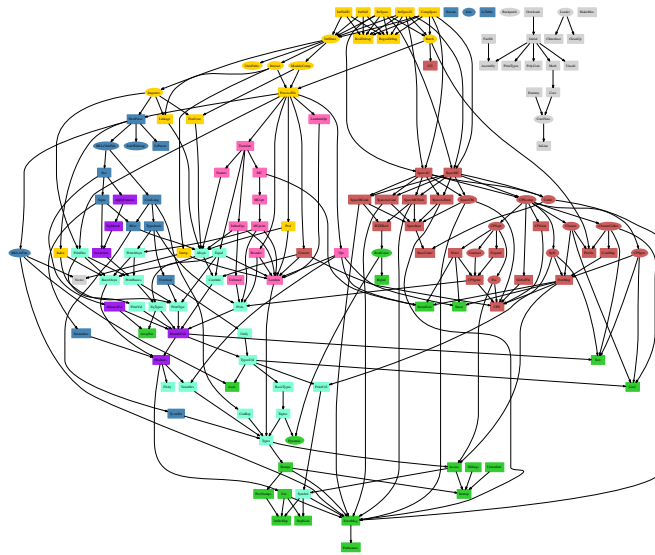

## 1 Basic Graph Drawing

*dot* draws directed graphs. It reads attributed graph text files and writes drawings, either as graph files or in a graphics format such as GIF, PNG, SVG or PostScript (which can be converted to PDF).

*dot* draws a graph in four main phases. Knowing this helps you to understand what kind of layouts *dot* makes and how you can control them. The layout procedure used by *dot* relies on the graph being acyclic. Thus, the first step is to break any cycles which occur in the input graph by reversing the internal direction of certain cyclic edges. The next step assigns nodes to discrete ranks or levels. In a top-to-bottom drawing, ranks determine *Y* coordinates. Edges that span more than one rank are broken into chains of “virtual” nodes and unit-length edges. The third step orders nodes within ranks to avoid crossings. The fourth step sets *X* coordinates of nodes to keep edges short, and the final step routes edge splines. This is the same general approach as most hierarchical graph drawing programs, based on the work of Warfield [War77], Carpano [Car80] and Sugiyama [STT81]. We refer the reader to [GKNV93] for a thorough explanation of *dot*'s algorithms.

*dot* accepts input in the *DOT* language (cf. Appendix A). This language describes three kinds of objects: graphs, nodes, and edges. The main (outermost) graph can be directed (*digraph*) or undirected *graph*. Because *dot* makes layouts of directed graphs, all the following examples use *digraph*. (A separate layout utility, *neato*, draws undirected graphs [Nor92].) Within a main graph, a *subgraph* defines a subset of nodes and edges.

Figure 1 is an example graph in the *DOT* language. Line 1 gives the graph name and type. The lines that follow create nodes, edges, or subgraphs, and set attributes. Names of all these objects may be C identifiers, numbers, or quoted C strings. Quotes protect punctuation and white space.

A node is created when its name first appears in the file. An edge is created when nodes are joined by the edge operator *->*. In the example, line 2 makes edges from *main* to *parse*, and from *parse* to *execute*. Running *dot* on this file (call it *graph1.dot*)

```
$ dot -Tps graph1.dot -o graph1.ps
```

yields the drawing of Figure 2. The command line option *-Tps* selects PostScript (EPSF) output. *graph1.ps* may be printed, displayed by a PostScript viewer, or embedded in another document.

It is often useful to adjust the representation or placement of nodes and edges in the layout. This is done by setting attributes of nodes, edges, or subgraphs in the input file. Attributes are name-value pairs of character strings. Figures 3 and 4 illustrate some layout attributes. In the listing of Figure 3, line 2 sets the graph's

```
1: digraph G {
2:     main -> parse -> execute;
3:     main -> init;
4:     main -> cleanup;
5:     execute -> make_string;
6:     execute -> printf
7:     init -> make_string;
8:     main -> printf;
9:     execute -> compare;
10: }
```

Figure 1: Small graph

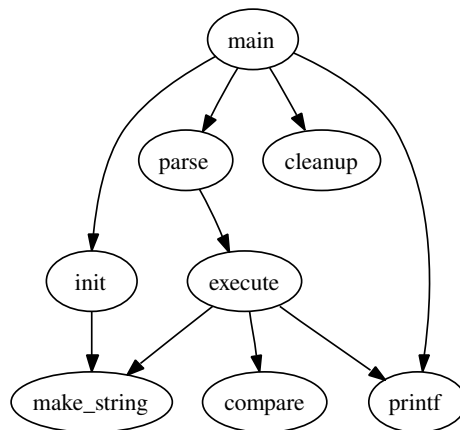

Figure 2: Drawing of small graph

size to 4,4 (in inches). This attribute controls the size of the drawing; if the drawing is too large, it is scaled as necessary to fit.

Node or edge attributes are set off in square brackets. In line 3, the node `main` is assigned shape `box`. The edge in line 4 is straightened by increasing its `weight` (the default is 1). The edge in line 6 is drawn as a dotted line. Line 8 makes edges from `execute` to `make_string` and `printf`. In line 10 the default edge color is set to `red`. This affects any edges created after this point in the file. Line 11 makes a bold edge labeled `100 times`. In line 12, node `make_string` is given a multi-line label. Line 13 changes the default node to be a box filled with a shade of blue. The node `compare` inherits these values.

## 2 Drawing Attributes

The complete list of attributes that affect graph drawing is summarized in Tables 1, 2 and 3.

### 2.1 Node Shapes

Nodes are drawn, by default, with `shape=ellipse`, `width=.75`, `height=.5` and labeled by the node name. Other common shapes include `box`, `circle`, `record` and `plaintext`. A complete list of node shapes is given in Appendix E. The node shape `plaintext` is of particular interest in that it draws a node without any outline, an important convention in some kinds of diagrams. In cases where the graph structure is of main concern, and especially when the graph is moderately large, the `point` shape reduces nodes to display minimal content. When drawn, a node's actual size is the greater of the requested size and the area needed for its text label, unless `fixedsize=true`, in which case the `width` and `height` values are enforced.

Node shapes fall into two broad categories: polygon-based and record-based.<sup>1</sup> All node shapes except `record` and `Mrecord` are considered polygonal, and are modeled by the number of sides (ellipses and circles being special cases), and a few other geometric properties. Some of these properties can be specified in a graph. If `regular=true`, the node is forced to be regular. The parameter `peripheries` sets the number of boundary curves drawn. For example, a `doublecircle` has `peripheries=2`. The `orientation` attribute specifies a clockwise rotation of the polygon, measured in degrees.

---

<sup>1</sup>There is a way to implement custom node shapes, using `shape=epsf` and the `shapefile` attribute, and relying on PostScript output. The details are beyond the scope of this user's guide. Please contact the authors for further information.

```

1: digraph G {
2:     size = "4,4";
3:     main [shape=box]; /* this is a comment */
4:     main -> parse [weight=8];
5:     parse -> execute;
6:     main -> init [style=dotted];
7:     main -> cleanup;
8:     execute -> { make_string; printf}
9:     init -> make_string;
10:    edge [color=red]; // so is this
11:    main -> printf [style=bold,label="100 times"];
12:    make_string [label="make a\nstring"];
13:    node [shape=box,style=filled,color=".7 .3 1.0"];
14:    execute -> compare;
15: }

```

Figure 3: Fancy graph

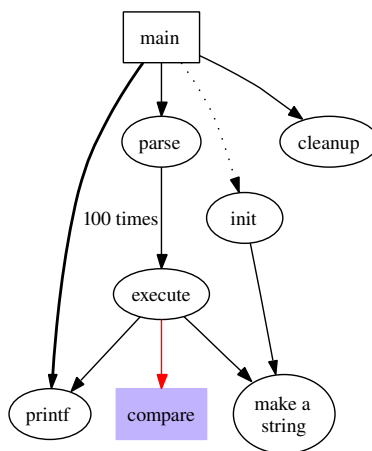

Figure 4: Drawing of fancy graph

The shape `polygon` exposes all the polygonal parameters, and is useful for creating many shapes that are not predefined. In addition to the parameters `regular`, `peripheries` and `orientation`, mentioned above, polygons are parameterized by number of sides `sides`, `skew` and `distortion`. `skew` is a floating point number (usually between  $-1.0$  and  $1.0$ ) that distorts the shape by slanting it from top-to-bottom, with positive values moving the top of the polygon to the right. Thus, `skew` can be used to turn a box into a parallelogram. `distortion` shrinks the polygon from top-to-bottom, with negative values causing the bottom to be larger than the top. `distortion` turns a box into a trapezoid. A variety of these polygonal attributes are illustrated in Figures 6 and 5.

Record-based nodes form the other class of node shapes. These include the shapes `record` and `Mrecord`. The two are identical except that the latter has rounded corners. These nodes represent recursive lists of fields, which are drawn as alternating horizontal and vertical rows of boxes. The recursive structure is determined by the node's `label`, which has the following schema:

```

rlabel      → field ( '|' field ) *
field       → boxLabel | '' rlabel ''
boxLabel    → [ '<' string '>' ] [ string ]

```

Literal braces, vertical bars and angle brackets must be escaped. Spaces are interpreted as separators between tokens, so they must be escaped if they are to appear literally in the text. The first string in a `boxLabel` gives a name to the field, and serves as a port name for the box (cf. Section 3.1). The second string is used as a label for the field; it may contain the same escape sequences as multi-line labels (cf. Section 2.2). The example of Figures 7 and 8 illustrates the use and some properties of records.

## 2.2 Labels

As mentioned above, the default node label is its name. Edges are unlabeled by default. Node and edge labels can be set explicitly using the `label` attribute as shown in Figure 4.

Though it may be convenient to label nodes by name, at other times labels must be set explicitly. For example, in drawing a file directory tree, one might have several directories named `src`, but each one must have a unique node identifier. The inode number or full path name are suitable unique identifiers. Then the label of each node can be set to the file name within its directory.

```
1: digraph G {  
2:   a -> b -> c;  
3:   b -> d;  
4:   a [shape=polygon,sides=5,peripheries=3,color=lightblue,style=filled];  
5:   c [shape=polygon,sides=4,skew=.4,label="hello world"]  
6:   d [shape=invtriangle];  
7:   e [shape=polygon,sides=4,distortion=.7];  
8: }
```

Figure 5: Graph with polygonal shapes

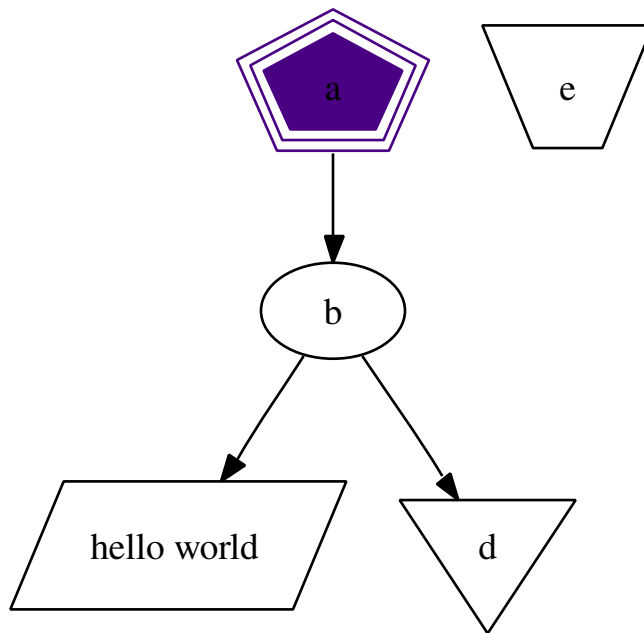

Figure 6: Drawing of polygonal node shapes

```

1: digraph structs {
2:   node [shape=record];
3:     struct1 [shape=record,label="<f0> left|<f1> mid\ dle|<f2> right"];
4:     struct2 [shape=record,label="<f0> one|<f1> two"];
5:     struct3 [shape=record,label="hello\nworld |{ b |{c|<here> d|e}| f}| g | h"];
6:     struct1 -> struct2;
7:     struct1 -> struct3;
8: }

```

Figure 7: Records with nested fields

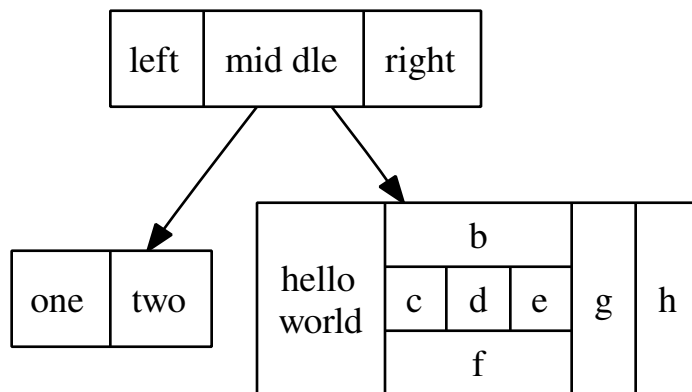

Figure 8: Drawing of records



Multi-line labels can be created by using the escape sequences `\n`, `\l`, `\r` to terminate lines that are centered, or left or right justified.<sup>2</sup>

The node shape `Mdiamond`, `Msquare` and `Mcircle` use the attributes `toplabel` and `bottomlabel` to specify additional labels appearing near the top and bottom of the nodes, respectively.

Graphs and cluster subgraphs may also have labels. Graph labels appear, by default, centered below the graph. Setting `labelloc=t` centers the label above the graph. Cluster labels appear within the enclosing rectangle, in the upper left corner. The value `labelloc=b` moves the label to the bottom of the rectangle. The setting `labeljust=r` moves the label to the right.

The default font is 14-point Times-Roman, in black. Other font families, sizes and colors may be selected using the attributes `fontname`, `fontsize` and `fontcolor`. Font names should be compatible with the target interpreter. It is best to use only the standard font families Times, Helvetica, Courier or Symbol as these are guaranteed to work with any target graphics language. For example, `Times-Italic`, `Times-Bold`, and `Courier` are portable; `AvanteGarde-DemiOblique` isn't.

For bitmap output, such as GIF or JPG, *dot* relies on having these fonts available during layout. The `fontpath` attribute can specify a list of directories<sup>3</sup> which should be searched for the font files. If this is not set, *dot* will use the `DOTFONTPATH` environment variable or, if this is not set, the `GDFONTPATH` environment variable. If none of these is set, *dot* uses a built-in list.

Edge labels are positioned near the center of the edge. Usually, care is taken to prevent the edge label from overlapping edges and nodes. It can still be difficult, in a complex graph, to be certain which edge a label belongs to. If the `decorate` attribute is set to true, a line is drawn connecting the label to its edge. Sometimes avoiding collisions among edge labels and edges forces the drawing to be bigger than desired. If `labelfloat=true`, *dot* does not try to prevent such overlaps, allowing a more compact drawing.

An edge can also specify additional labels, using `headlabel` and `taillabel`, which are placed near the ends of the edge. The characteristics of these labels are specified using the attributes `labelfontname`, `labelfontsize` and `labelfontcolor`. These labels are placed near the intersection of the edge and the node and, as such, may interfere with them. To tune a drawing, the user can set the `labelangle` and `labeldistance` attributes. The former sets the angle, in degrees, which the label is rotated from the angle the edge makes incident with

---

<sup>2</sup>The escape sequence `\N` is an internal symbol for node names.

<sup>3</sup>For Unix-based systems, this is a concatenated list of pathnames, separated by colons. For Windows-based systems, the pathnames are separated by semi-colons.

the node. The latter sets a multiplicative scaling factor to adjust the distance that the label is from the node.

### 2.3 Graphics Styles

Nodes and edges can specify a `color` attribute, with black the default. This is the color used to draw the node's shape or the edge. A `color` value can be a hue-saturation-brightness triple (three floating point numbers between 0 and 1, separated by commas); one of the colors names listed in Appendix G (borrowed from some version of the X window system); or a red-green-blue (RGB) triple<sup>4</sup> (three hexadecimal number between 00 and FF, preceded by the character '#'). Thus, the values "orchid", "0.8396,0.4862,0.8549" and #DA70D6 are three ways to specify the same color. The numerical forms are convenient for scripts or tools that automatically generate colors. Color name lookup is case-insensitive and ignores non-alphanumeric characters, so `warmgrey` and `Warm_Grey` are equivalent.

We can offer a few hints regarding use of color in graph drawings. First, avoid using too many bright colors. A "rainbow effect" is confusing. It is better to choose a narrower range of colors, or to vary saturation along with hue. Second, when nodes are filled with dark or very saturated colors, labels seem to be more readable with `fontcolor=white` and `fontname=Helvetica`. (We also have PostScript functions for *dot* that create outline fonts from plain fonts.) Third, in certain output formats, you can define your own color space. For example, if using PostScript for output, you can redefine `nodecolor`, `edgecolor`, or `graphcolor` in a library file. Thus, to use RGB colors, place the following line in a file `lib.ps`.

```
/nodecolor {setrgbcolor} bind def
```

Use the `-l` command line option to load this file.

```
dot -Tps -l lib.ps file.dot -o file.ps
```

The `style` attribute controls miscellaneous graphics features of nodes and edges. This attribute is a comma-separated list of primitives with optional argument lists. The predefined primitives include `solid`, `dashed`, `dotted`, `bold` and `invis`. The first four control line drawing in node boundaries and edges and have the obvious meaning. The value `invis` causes the node or edge to be left undrawn. The style for nodes can also include `filled`, `diagonals` and

---

<sup>4</sup>A fourth form, RGBA, is also supported, which has the same format as RGB with an additional fourth hexadecimal number specifying alpha channel or transparency information.

Name	Default	Values
bottomlabel		auxiliary label for nodes of shape M*
color	black	node shape color
comment		any string (format-dependent)
distortion	0.0	node distortion for shape=polygon
fillcolor	lightgrey/black	node fill color
fixedsize	false	label text has no affect on node size
fontcolor	black	type face color
fontname	Times-Roman	font family
fontsize	14	point size of label
group		name of node's group
height	.5	height in inches
label	node name	any string
layer	overlay range	all, <i>id</i> or <i>id:id</i>
orientation	0.0	node rotation angle
peripheries	shape-dependent	number of node boundaries
regular	false	force polygon to be regular
shape	ellipse	node shape; see Section 2.1 and Appendix E
shapefile		external EPSF or SVG custom shape file
sides	4	number of sides for shape=polygon
skew	0.0	skewing of node for shape=polygon
style		graphics options, e.g. bold, dotted, filled; cf. Section 2.3
toplabel		auxiliary label for nodes of shape M*
URL		URL associated with node (format-dependent)
width	.75	width in inches
z	0.0	z coordinate for VRML output

Table 1: Node attributes

Name	Default	Values
arrowhead	normal	style of arrowhead at head end
arrowsize	1.0	scaling factor for arrowheads
arrowtail	normal	style of arrowhead at tail end
color	black	edge stroke color
comment		any string (format-dependent)
constraint	true	use edge to affect node ranking
decorate		if set, draws a line connecting labels with their edges
dir	forward	forward, back, both, or none
fontcolor	black	type face color
fontname	Times-Roman	font family
fontsize	14	point size of label
headlabel		label placed near head of edge
headport		n, ne, e, se, s, sw, w, nw
headURL		URL attached to head label if output format is ismap
label		edge label
labelangle	-25.0	angle in degrees which head or tail label is rotated off edge
labeldistance	1.0	scaling factor for distance of head or tail label from node
labelfloat	false	lessen constraints on edge label placement
labelfontcolor	black	type face color for head and tail labels
labelfontname	Times-Roman	font family for head and tail labels
labelfontsize	14	point size for head and tail labels
layer	overlay range	all, <i>id</i> or <i>id:id</i>
lhead		name of cluster to use as head of edge
ltail		name of cluster to use as tail of edge
minlen	1	minimum rank distance between head and tail
samehead		tag for head node; edge heads with the same tag are merged onto the same port
sametail		tag for tail node; edge tails with the same tag are merged onto the same port
style		graphics options, e.g. bold, dotted, filled; cf. Section 2.3
taillabel		label placed near tail of edge
tailport		n, ne, e, se, s, sw, w, nw
tailURL		URL attached to tail label if output format is ismap
weight	1	integer cost of stretching an edge

Table 2: Edge attributes

Name	Default	Values
bgcolor		background color for drawing, plus initial fill color
center	false	center drawing on page
clusterrank	local	may be global or none
color	black	for clusters, outline color, and fill color if fillcolor not defined
comment		any string (format-dependent)
compound	false	allow edges between clusters
concentrate	false	enables edge concentrators
fillcolor	black	cluster fill color
fontcolor	black	type face color
fontname	Times-Roman	font family
fontpath		list of directories to search for fonts
fontsize	14	point size of label
label		any string
labeljust	centered	"l" and "r" for left- and right-justified cluster labels, respectively
labelloc	top	"t" and "b" for top- and bottom-justified cluster labels, respectively
layers		<i>id:id:id...</i>
margin	.5	margin included in page, inches
mclimit	1.0	scale factor for mincross iterations
nodesep	.25	separation between nodes, in inches.
nslimit		if set to <i>f</i> , bounds network simplex iterations by <i>f</i> (number of nodes) when setting x-coordinates
nslimit1		if set to <i>f</i> , bounds network simplex iterations by <i>f</i> (number of nodes) when ranking nodes
ordering		if out out edge order is preserved
orientation	portrait	if rotate is not used and the value is landscape, use landscape orientation
page		unit of pagination, e.g. "8.5,11"
pagedir	BL	traversal order of pages
quantum		if quantum $\leq$ 0.0, node label dimensions will be rounded to integral multiples of quantum
rank		same, min, max, source or sink
rankdir	TB	LR (left to right) or TB (top to bottom)
ranksep	.75	separation between ranks, in inches.
ratio		approximate aspect ratio desired, fill or auto
remincross		if true and there are multiple clusters, re-run crossing minimization
rotate		If 90, set orientation to landscape
samplepoints	8	number of points used to represent ellipses and circles on output (cf. Appendix C)
searchsize	30	maximum edges with negative cut values to check when looking for a minimum one during network simplex
size		maximum drawing size, in inches
style		graphics options, e.g. filled for clusters
URL		URL associated with graph (format-dependent)

Table 3: Graph attributes

rounded. filled shades inside the node using the color `fillcolor`. If this is not set, the value of `color` is used. If this also is unset, light grey<sup>5</sup> is used as the default. The `diagonals` style causes short diagonal lines to be drawn between pairs of sides near a vertex. The `rounded` style rounds polygonal corners.

User-defined style primitives can be implemented as custom PostScript procedures. Such primitives are executed inside the `gsave` context of a graph, node, or edge, before any of its marks are drawn. The argument lists are translated to PostScript notation. For example, a node with `style="setlinewidth(8)"` is drawn with a thick outline. Here, `setlinewidth` is a PostScript built-in, but user-defined PostScript procedures are called the same way. The definition of these procedures can be given in a library file loaded using `-l` as shown above.

Edges have a `dir` attribute to set arrowheads. `dir` may be `forward` (the default), `back`, `both`, or `none`. This refers only to where arrowheads are drawn, and does not change the underlying graph. For example, setting `dir=back` causes an arrowhead to be drawn at the tail and no arrowhead at the head, but it does not exchange the endpoints of the edge. The attributes `arrowhead` and `arrowtail` specify the style of arrowhead, if any, which is used at the head and tail ends of the edge. Allowed values are `normal`, `inv`, `dot`, `invdot`, `odot`, `invodot` and `none` (cf. Appendix F). The attribute `arrowsize` specifies a multiplicative factor affecting the size of any arrowhead drawn on the edge. For example, `arrowsize=2.0` makes the arrow twice as long and twice as wide.

In terms of style and color, clusters act somewhat like large box-shaped nodes, in that the cluster boundary is drawn using the cluster's `color` attribute and, in general, the appearance of the cluster is affected the `style`, `color` and `fillcolor` attributes.

If the root graph has a `bgcolor` attribute specified, this color is used as the background for the entire drawing, and also serves as the default fill color.

## 2.4 Drawing Orientation, Size and Spacing

Two attributes that play an important role in determining the size of a *dot* drawing are `nodesep` and `ranksep`. The first specifies the minimum distance, in inches, between two adjacent nodes on the same rank. The second deals with rank separation, which is the minimum vertical space between the bottoms of nodes in one rank and the tops of nodes in the next. The `ranksep` attribute sets the rank separation, in inches. Alternatively, one can have `ranksep=equally`. This guarantees that all of the ranks are equally spaced, as measured from the centers of nodes on adjacent ranks. In this case, the rank separation between two ranks is at least the

---

<sup>5</sup>The default is black if the output format is MIF, or if the shape is `point`.

default rank separation. As the two uses of `ranksep` are independent, both can be set at the same time. For example, `ranksep="1.0 equally"` causes ranks to be equally spaced, with a minimum rank separation of 1 inch.

Often a drawing made with the default node sizes and separations is too big for the target printer or for the space allowed for a figure in a document. There are several ways to try to deal with this problem. First, we will review how *dot* computes the final layout size.

A layout is initially made internally at its “natural” size, using default settings (unless `ratio=compress` was set, as described below). There is no bound on the size or aspect ratio of the drawing, so if the graph is large, the layout is also large. If you don't specify `size` or `ratio`, then the natural size layout is printed.

The easiest way to control the output size of the drawing is to set `size="x,y"` in the graph file (or on the command line using `-G`). This determines the size of the final layout. For example, `size="7.5,10"` fits on an 8.5x11 page (assuming the default page orientation) no matter how big the initial layout.

`ratio` also affects layout size. There are a number of cases, depending on the settings of `size` and `ratio`.

**Case 1.** `ratio` was not set. If the drawing already fits within the given `size`, then nothing happens. Otherwise, the drawing is reduced uniformly enough to make the critical dimension fit.

If `ratio` was set, there are four subcases.

**Case 2a.** If `ratio=x` where  $x$  is a floating point number, then the drawing is scaled up in one dimension to achieve the requested ratio expressed as drawing *height/width*. For example, `ratio=2.0` makes the drawing twice as high as it is wide. Then the layout is scaled using `size` as in Case 1.

**Case 2b.** If `ratio=fill` and `size=x,y` was set, then the drawing is scaled up in one dimension to achieve the ratio  $y/x$ . Then scaling is performed as in Case 1. The effect is that all of the bounding box given by `size` is filled.

**Case 2c.** If `ratio=compress` and `size=x,y` was set, then the initial layout is compressed to attempt to fit it in the given bounding box. This trades off layout quality, balance and symmetry in order to pack the layout more tightly. Then scaling is performed as in Case 1.

**Case 2d.** If `ratio=auto` and the `page` attribute is set and the graph cannot be drawn on a single page, then `size` is ignored and *dot* computes an “ideal” size. In particular, the size in a given dimension will be the smallest integral multiple of the page size in that dimension which is at least half the current size. The two dimensions are then scaled independently to the new size.

If `rotate=90` is set, or `orientation=landscape`, then the drawing is rotated 90° into landscape mode. The  $X$  axis of the layout would be along the  $Y$  axis of each page. This does not affect *dot*'s interpretation of `size`, `ratio` or

page.

At this point, if `page` is not set, then the final layout is produced as one page.

If `page=x,y` is set, then the layout is printed as a sequence of pages which can be tiled or assembled into a mosaic. Common settings are `page="8.5,11"` or `page="11,17"`. These values refer to the full size of the physical device; the actual area used will be reduced by the margin settings. (For printer output, the default is 0.5 inches; for bitmap-output, the *X* and *Y* margins are 10 and 2 points, respectively.) For tiled layouts, it may be helpful to set smaller margins. This can be done by using the `margin` attribute. This can take a single number, used to set both margins, or two numbers separated by a comma to set the *x* and *y* margins separately. As usual, units are in inches. Although one can set `margin=0`, unfortunately, many bitmap printers have an internal hardware margin that cannot be overridden.

The order in which pages are printed can be controlled by the `pagedir` attribute. Output is always done using a row-based or column-based ordering, and `pagedir` is set to a two-letter code specifying the major and minor directions. For example, the default is `BL`, specifying a bottom-to-top (`B`) major order and a left-to-right (`L`) minor order. Thus, the bottom row of pages is emitted first, from left to right, then the second row up, from left to right, and finishing with the top row, from left to right. The top-to-bottom order is represented by `T` and the right-to-left order by `R`.

If `center=true` and the graph can be output on one page, using the default page size of 8.5 by 11 inches if `page` is not set, the graph is repositioned to be centered on that page.

A common problem is that a large graph drawn at a small size yields unreadable node labels. To make larger labels, something has to give. There is a limit to the amount of readable text that can fit on one page. Often you can draw a smaller graph by extracting an interesting piece of the original graph before running *dot*. We have some tools that help with this.

**sccmap** decompose the graph into strongly connected components

**tred** compute transitive reduction (remove edges implied by transitivity)

**gvpr** graph processor to select nodes or edges, and contract or remove the rest of the graph

**unflatten** improve aspect ratio of trees by staggering the lengths of leaf edges

With this in mind, here are some thing to try on a given graph:

1. Increase the node `fontsize`.



2. Use smaller `ranksep` and `nodesep`.
3. Use `ratio=auto`.
4. Use `ratio=compress` and give a reasonable `size`.
5. A sans serif font (such as Helvetica) may be more readable than Times when reduced.

## 2.5 Node and Edge Placement

Attributes in *dot* provide many ways to adjust the large-scale layout of nodes and edges, as well as fine-tune the drawing to meet the user's needs and tastes. This section discusses these attributes<sup>6</sup>.

Sometimes it is natural to make edges point from left to right instead of from top to bottom. If `rankdir=LR` in the top-level graph, the drawing is rotated in this way. `TB` (top to bottom) is the default. The mode `rankdir=BT` is useful for drawing upward-directed graphs. For completeness, one can also have `rankdir=RL`.

In graphs with time-lines, or in drawings that emphasize source and sink nodes, you may need to constrain rank assignments. The `rank` of a subgraph may be set to `same`, `min`, `source`, `max` or `sink`. A value `same` causes all the nodes in the subgraph to occur on the same rank. If set to `min`, all the nodes in the subgraph are guaranteed to be on a rank at least as small as any other node in the layout<sup>7</sup>. This can be made strict by setting `rank=source`, which forces the nodes in the subgraph to be on some rank strictly smaller than the rank of any other nodes (except those also specified by `min` or `source` subgraphs). The values `max` or `sink` play an analogous role for the maximum rank. Note that these constraints induce equivalence classes of nodes. If one subgraph forces nodes A and B to be on the same rank, and another subgraph forces nodes C and B to share a rank, then all nodes in both subgraphs must be drawn on the same rank. Figures 9 and 10 illustrate using subgraphs for controlling rank assignment.

In some graphs, the left-to-right ordering of nodes is important. If a subgraph has `ordering=out`, then out-edges within the subgraph that have the same tail node will fan-out from left to right in their order of creation. (Also note that flat edges involving the head nodes can potentially interfere with their ordering.)

There are many ways to fine-tune the layout of nodes and edges. For example, if the nodes of an edge both have the same `group` attribute, *dot* tries to keep

---

<sup>6</sup>For completeness, we note that *dot* also provides access to various parameters which play technical roles in the layout algorithms. These include `mclimit`, `nslimit`, `nslimit1`, `remincross` and `searchsize`.

<sup>7</sup>Recall that the minimum rank occurs at the top of a drawing.

```

digraph asde91 {
    ranksep=.75; size = "7.5,7.5";

    {
        node [shape=plaintext, fontsize=16];
        /* the time-line graph */
        past -> 1978 -> 1980 -> 1982 -> 1983 -> 1985 -> 1986 ->
            1987 -> 1988 -> 1989 -> 1990 -> "future";
        /* ancestor programs */
        "Bourne sh"; "make"; "SCCS"; "yacc"; "cron"; "Reiser cpp";
        "Cshell"; "emacs"; "build"; "vi"; "<curses>"; "RCS"; "C*";
    }

    { rank = same;
      "Software IS"; "Configuration Mgt"; "Architecture & Libraries";
      "Process";
    };

    node [shape=box];
    { rank = same; "past"; "SCCS"; "make"; "Bourne sh"; "yacc"; "cron"; }
    { rank = same; 1978; "Reiser cpp"; "Cshell"; }
    { rank = same; 1980; "build"; "emacs"; "vi"; }
    { rank = same; 1982; "RCS"; "<curses>"; "IMX"; "SYNED"; }
    { rank = same; 1983; "ksh"; "IFS"; "TTU"; }
    { rank = same; 1985; "nmake"; "Peggy"; }
    { rank = same; 1986; "C*"; "ncpp"; "ksh-i"; "<curses-i>"; "PG2"; }
    { rank = same; 1987; "Ansi cpp"; "nmake 2.0"; "3D File System"; "fdelta";
      "DAG"; "CSAS"; }
    { rank = same; 1988; "CIA"; "SBCS"; "ksh-88"; "PEGASUS/PML"; "PAX";
      "backtalk"; }
    { rank = same; 1989; "CIA++"; "APP"; "SHIP"; "DataShare"; "ryacc";
      "Mosaic"; }
    { rank = same; 1990; "libft"; "CoShell"; "DIA"; "IFS-i"; "kyacc"; "sfio";
      "yeast"; "ML-X"; "DOT"; }
    { rank = same; "future"; "Adv. Software Technology"; }

    "PEGASUS/PML" -> "ML-X";
    "SCCS" -> "nmake";
    "SCCS" -> "3D File System";
    "SCCS" -> "RCS";
    "make" -> "nmake";
    "make" -> "build";
    .
    .
    .
}

```

Figure 9: Graph with constrained ranks

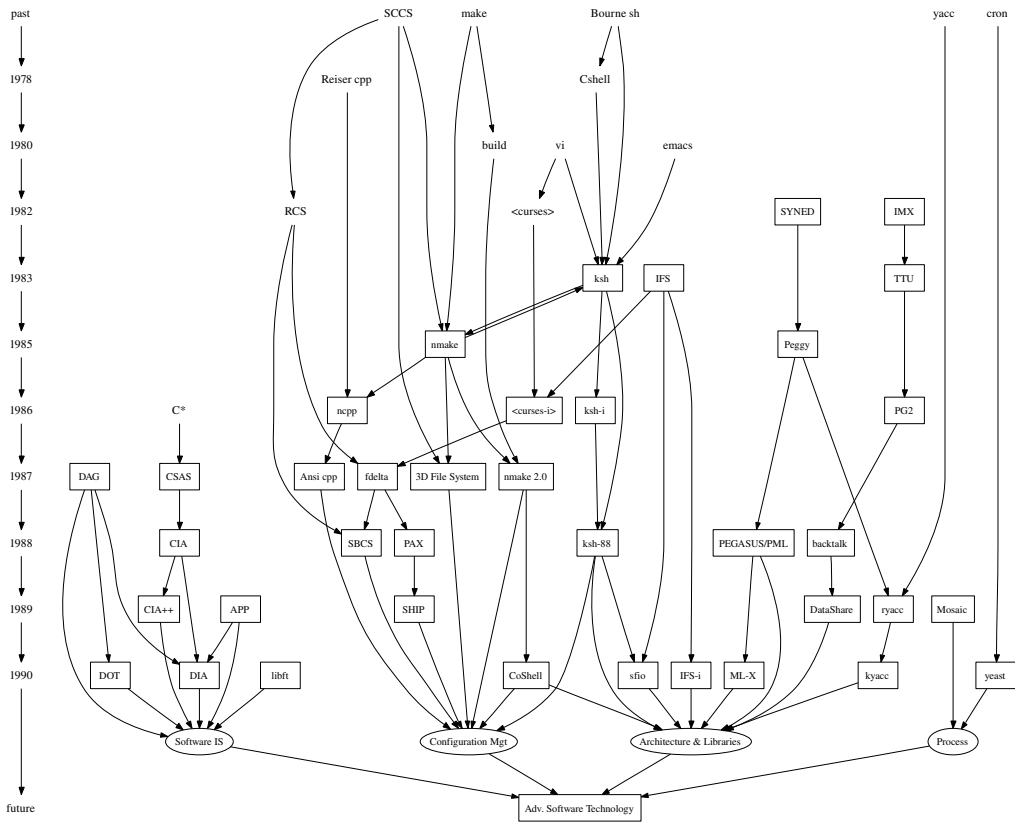

Figure 10: Drawing with constrained ranks

the edge straight and avoid having other edges cross it. The `weight` of an edge provides another way to keep edges straight. An edge's `weight` suggests some measure of an edge's importance; thus, the heavier the weight, the closer together its nodes should be. *dot* causes edges with heavier weights to be drawn shorter and straighter.

Edge weights also play a role when nodes are constrained to the same rank. Edges with non-zero weight between these nodes are aimed across the rank in the same direction (left-to-right, or top-to-bottom in a rotated drawing) as far as possible. This fact may be exploited to adjust node ordering by placing invisible edges (`style="invis"`) where needed.

The end points of edges adjacent to the same node can be constrained using the `samehead` and `sametail` attributes. Specifically, all edges with the same head and the same value of `samehead` are constrained to intersect the head node at the same point. The analogous property holds for tail nodes and `sametail`.

During rank assignment, the head node of an edge is constrained to be on a higher rank than the tail node. If the edge has `constraint=false`, however, this requirement is not enforced.

In certain circumstances, the user may desire that the end points of an edge never get too close. This can be obtained by setting the edge's `minlen` attribute. This defines the minimum difference between the ranks of the head and tail. For example, if `minlen=2`, there will always be at least one intervening rank between the head and tail. Note that this is not concerned with the geometric distance between the two nodes.

Fine-tuning should be approached cautiously. *dot* works best when it can make a layout without much "help" or interference in its placement of individual nodes and edges. Layouts can be adjusted somewhat by increasing the `weight` of certain edges, or by creating invisible edges or nodes using `style=invis`, and sometimes even by rearranging the order of nodes and edges in the file. But this can backfire because the layouts are not necessarily stable with respect to changes in the input graph. One last adjustment can invalidate all previous changes and make a very bad drawing. A future project we have in mind is to combine the mathematical layout techniques of *dot* with an interactive front-end that allows user-defined hints and constraints.

## 3 Advanced Features

### 3.1 Node Ports

A node port is a point where edges can attach to a node. (When an edge is not attached to a port, it is aimed at the node's center and the edge is clipped at the

node's boundary.)

Simple ports can be specified by using the `headport` and `tailport` attributes. These can be assigned one of the 8 compass points "n", "ne", "e", "se", "s", "sw", "w" or "nw". The end of the node will then be aimed at that position on the node. Thus, if `tailport=se`, the edge will connect to the tail node at its southeast "corner".

Nodes with a `record` shape use the record structure to define ports. As noted above, this shape represents a record as recursive lists of boxes. If a box defines a port name, by using the construct `< port_name >` in the box label, the center of the box can be used as a port. (By default, the edge is clipped to the box's boundary.) This is done by modifying the node name with the port name, using the syntax `node_name:port_name`, as part of an edge declaration. Figure 11 illustrates the declaration and use of port names in record nodes, with the resulting drawing shown in Figure 12.

**DISCLAIMER: At present, simple ports don't work as advertised, even when they should. There is also the case where we might not want them to work, e.g., when the `tailport=n` and the `headport=s`. Finally, in theory, dot should be able to allow both types of ports on an edge, since the notions are orthogonal. There is still the question as to whether the two syntaxes could be combined, i.e., treat the compass points as reserved port names, and allow `nodename:portname:compassname`.**

Figures 13 and 14 give another example of the use of record nodes and ports. This repeats the example of Figures 7 and 8 but now using ports as connectors for edges. Note that records sometimes look better if their input height is set to a small value, so the text labels dominate the actual size, as illustrated in Figure 11. Otherwise the default node size (.75 by .5) is assumed, as in Figure 14. The example of Figures 15 and 16 uses left-to-right drawing in a layout of a hash table.

## 3.2 Clusters

A cluster is a subgraph placed in its own distinct rectangle of the layout. A subgraph is recognized as a cluster when its name has the prefix `cluster`. (If the top-level graph has `clusterrank=none`, this special processing is turned off). Labels, font characteristics and the `labelloc` attribute can be set as they would be for the top-level graph, though cluster labels appear above the graph by default. For clusters, the label is left-justified by default; if `labeljust="r"`, the label is right-justified. The `color` attribute specifies the color of the enclosing rectangle. In addition, clusters may have `style="filled"`, in which case the rectangle is filled with the color specified by `fillcolor` before the cluster is drawn. (If

```

1: digraph g {
2: node [shape = record,height=.1];
3: node0[label = "<f0> |<f1> G|<f2> "];
4: node1[label = "<f0> |<f1> E|<f2> "];
5: node2[label = "<f0> |<f1> B|<f2> "];
6: node3[label = "<f0> |<f1> F|<f2> "];
7: node4[label = "<f0> |<f1> R|<f2> "];
8: node5[label = "<f0> |<f1> H|<f2> "];
9: node6[label = "<f0> |<f1> Y|<f2> "];
10: node7[label = "<f0> |<f1> A|<f2> "];
11: node8[label = "<f0> |<f1> C|<f2> "];
12: "node0":f2 -> "node4":f1;
13: "node0":f0 -> "node1":f1;
14: "node1":f0 -> "node2":f1;
15: "node1":f2 -> "node3":f1;
16: "node2":f2 -> "node8":f1;
17: "node2":f0 -> "node7":f1;
18: "node4":f2 -> "node6":f1;
19: "node4":f0 -> "node5":f1;
20: }

```

Figure 11: Binary search tree using records

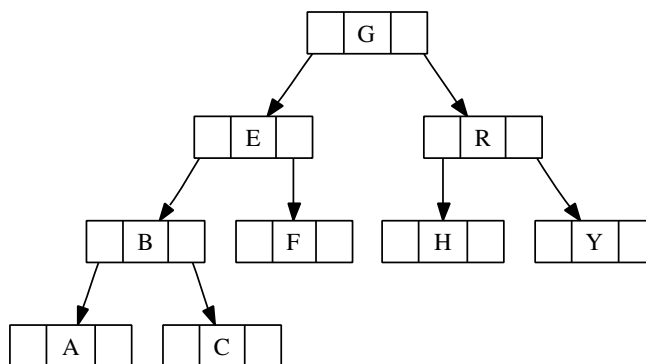

Figure 12: Drawing of binary search tree

```

1: digraph structs {
2:   node [shape=record];
3:     struct1 [shape=record,label="<f0> left|<f1> middle|<f2> right"];
4:     struct2 [shape=record,label="<f0> one|<f1> two"];
5:     struct3 [shape=record,label="hello\nworld |{ b |{c|<here> d|e}| f}| g | h"];
6:     struct1:f1 -> struct2:f0;
7:     struct1:f2 -> struct3:here;
8: }

```

Figure 13: Records with nested fields (revisited)

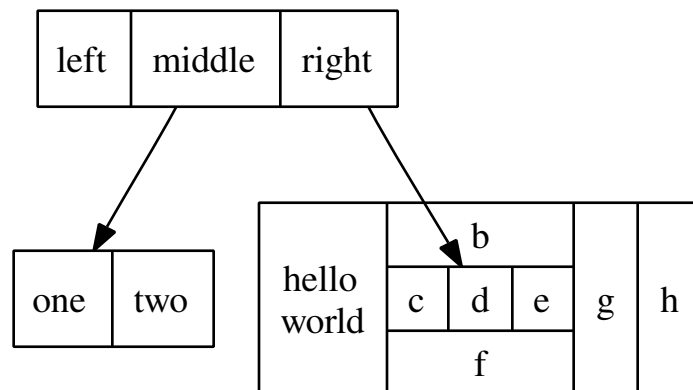

Figure 14: Drawing of records (revisited)

```

1: digraph G {
2:   nodesep=.05;
3:   rankdir=LR;
4:   node [shape=record,width=.1,height=.1];
5:
6:   node0 [label = "<f0> |<f1> |<f2> |<f3> |<f4> |<f5> |<f6> | ",height=2.5];
7:   node [width = 1.5];
8:   node1 [label = "{<n> n14 | 719 |<p> }"];
9:   node2 [label = "{<n> a1 | 805 |<p> }"];
10:  node3 [label = "{<n> i9 | 718 |<p> }"];
11:  node4 [label = "{<n> e5 | 989 |<p> }"];
12:  node5 [label = "{<n> t20 | 959 |<p> }"] ;
13:  node6 [label = "{<n> o15 | 794 |<p> }"] ;
14:  node7 [label = "{<n> s19 | 659 |<p> }"] ;
15:
16:  node0:f0 -> node1:n;
17:  node0:f1 -> node2:n;
18:  node0:f2 -> node3:n;
19:  node0:f5 -> node4:n;
20:  node0:f6 -> node5:n;
21:  node2:p -> node6:n;
22:  node4:p -> node7:n;
23: }

```

Figure 15: Hash table graph file

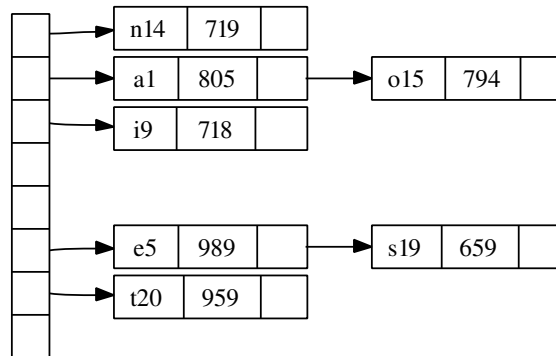

Figure 16: Drawing of hash table



`fillcolor` is not specified, the cluster's `color` attribute is used.)

Clusters are drawn by a recursive technique that computes a rank assignment and internal ordering of nodes within clusters. Figure 17 through 19 are cluster layouts and the corresponding graph files.

```

digraph G {
  subgraph cluster0 {
    node [style=filled,color=white
    style=filled;
    color=lightgrey;
    a0 -> a1 -> a2 -> a3;
    label = "process #1";
  }

  subgraph cluster1 {
    node [style=filled];
    b0 -> b1 -> b2 -> b3;
    label = "process #2";
    color=blue
  }

  start -> a0;
  start -> b0;
  a1 -> b3;
  b2 -> a3;
  a3 -> a0;
  a3 -> end;
  b3 -> end;

  start [shape=Mdiamond];
  end [shape=Msquare];
}

```

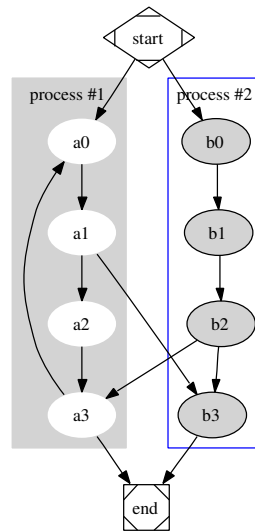

Figure 17: Process diagram with clusters

If the top-level graph has the `compound` attribute set to `true`, *dot* will allow edges connecting nodes and clusters. This is accomplished by an edge defining an `lhead` or `ltail` attribute. The value of these attributes must be the name of a cluster containing the head or tail node, respectively. In this case, the edge is clipped at the cluster boundary. All other edge attributes, such as `arrowhead` or `dir`, are applied to the truncated edge. For example, Figure 20 shows a graph using the `compound` attribute and the resulting diagram.

### 3.3 Concentrators

Setting `concentrate=true` on the top-level graph enables an edge merging technique to reduce clutter in dense layouts. Edges are merged when they run parallel, have a common endpoint and have length greater than 1. A beneficial side-effect in fixed-sized layouts is that removal of these edges often permits larger, more readable labels. While concentrators in *dot* look somewhat like Newbery's [New89], they are found by searching the edges in the layout, not by detecting complete bipartite graphs in the underlying graph. Thus the *dot* approach runs much faster but doesn't collapse as many edges as Newbery's algorithm.

## 4 Command Line Options

By default, *dot* operates in filter mode, reading a graph from `stdin`, and writing the graph on `stdout` in the *DOT* format with layout attributes appended. *dot* supports a variety of command-line options:

`-Tformat` sets the format of the output. Allowed values for *format* are:

`canon` Prettyprint input; no layout is done.

`dot` Attributed *DOT*. Prints input with layout information attached as attributes, cf. Appendix C.

`fig` FIG output.

`gd` GD format. This is the internal format used by the GD Graphics Library. An alternate format is `gd2`.

`gif` GIF output.

`hpgl` HP-GL/2 vector graphic printer language for HP wide bed plotters.

`imap` Produces map files for server-side image maps. This can be combined with a graphical form of the output, e.g., using `-Tgif` or `-Tjpg`, in web pages

```

1: digraph G {
2:   size="8,6"; ratio=fill; node[fontsize=24];
3:
4:   ciafan->computefan; fan->increment; computefan->fan; stringdup->fatal;
5:   main->exit; main->interp_err; main->ciafan; main->fatal; main->malloc;
6:   main->strcpy; main->getopt; main->init_index; main->strlen; fan->fatal;
7:   fan->ref; fan->interp_err; ciafan->def; fan->free; computefan->stdprintf;
8:   computefan->get_sym_fields; fan->exit; fan->malloc; increment->strcmp;
9:   computefan->malloc; fan->stdsprintf; fan->strlen; computefan->strcmp;
10:  computefan->realloc; computefan->strlen; debug->sfprintf; debug->strcat;
11:  stringdup->malloc; fatal->sfprintf; stringdup->strcpy; stringdup->strlen;
12:  fatal->exit;
13:
14:  subgraph "cluster_error.h" { label="error.h"; interp_err; }
15:
16:  subgraph "cluster_sfio.h" { label="sfio.h"; sprintf; }
17:
18:  subgraph "cluster_ciafan.c" { label="ciafan.c"; ciafan; computefan;
19:    increment; }
20:
21:  subgraph "cluster_util.c" { label="util.c"; stringdup; fatal; debug; }
22:
23:  subgraph "cluster_query.h" { label="query.h"; ref; def; }
24:
25:  subgraph "cluster_field.h" { get_sym_fields; }
26:
27:  subgraph "cluster_stdio.h" { label="stdio.h"; stdprintf; stdsprintf; }
28:
29:  subgraph "cluster_<libc.a>" { getopt; }
30:
31:  subgraph "cluster_stdlib.h" { label="stdlib.h"; exit; malloc; free; realloc; }
32:
33:  subgraph "cluster_main.c" { main; }
34:
35:  subgraph "cluster_index.h" { init_index; }
36:
37:  subgraph "cluster_string.h" { label="string.h"; strcpy; strlen; strcmp; strcat; }
38:}

```

Figure 18: Call graph file

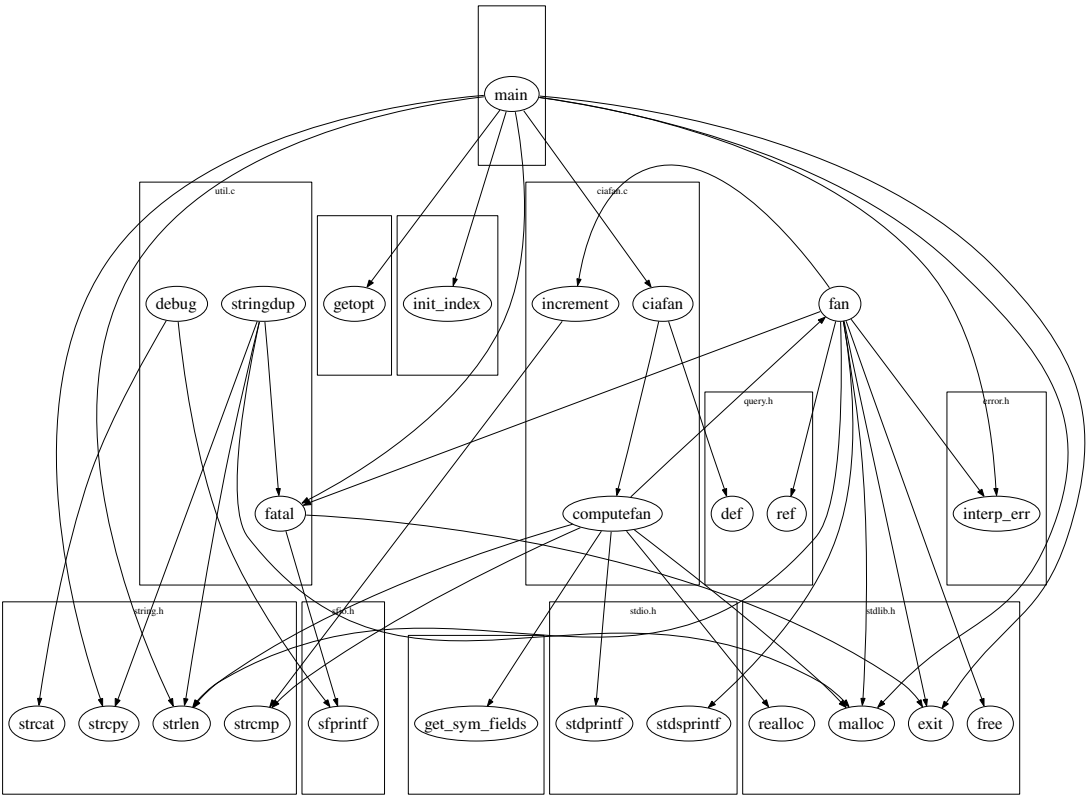

Figure 19: Call graph with labeled clusters

```

digraph G {
  compound=true;
  subgraph cluster0 {
    a -> b;
    a -> c;
    b -> d;
    c -> d;
  }
  subgraph cluster1 {
    e -> g;
    e -> f;
  }
  b -> f [lhead=cluster1];
  d -> e;
  c -> g [ltail=cluster0,
           lhead=cluster1];
  c -> e [ltail=cluster0];
  d -> h;
}

```

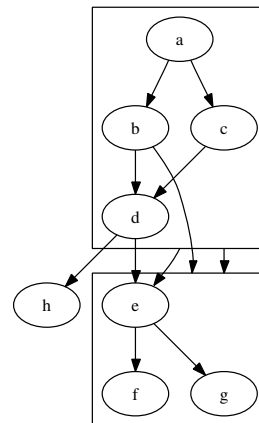

Figure 20: Graph with edges on clusters

to attach links to nodes and edges. The format `ismap` is a predecessor of the `imap` format.

`cmap` Produces HTML map files for client-side image maps.

`jpg` JPEG output. `jpeg` is a synonym for `jpg`.

`mif` FrameMaker MIF format. In this format, graphs can be loaded into FrameMaker and edited manually. MIF is limited to 8 basic colors.

`mp` MetaPost output.

`pcl` PCL-5 output for HP laser writers.

`pic` PIC output.

`plain` Simple, line-based ASCII format. Appendix B describes this output. An alternate format is `plain-ext`, which provides port names on the head and tail nodes of edges.

`png` PNG (Portable Network Graphics) output.

`ps` PostScript (EPSF) output.

`ps2` PostScript (EPSF) output with PDF annotations. It is assumed that this output will be distilled into PDF.

`svg` SVG output. The alternate form `svgz` produces compressed SVG.

`vrml` VRML output.

`vtx` VTX format for r Confluents's Visual Thought.

`wbmp` Wireless BitMap (WBMP) format.

`-Gname=value` sets a graph attribute default value. Often it is convenient to set size, pagination, and related values on the command line rather than in the graph file. The analogous flags `-N` or `-E` set default node or edge attributes. Note that file contents override command line arguments.

`-llibfile` specifies a device-dependent graphics library file. Multiple libraries may be given. These names are passed to the code generator at the beginning of output.

`-ooutfile` writes output into file *outfile*.

`-v` requests verbose output. In processing large layouts, the verbose messages may give some estimate of *dot*'s progress.

`-V` prints the version number and exits.

## 5 Miscellaneous

In the top-level graph heading, a graph may be declared a `strict digraph`. This forbids the creation of self-arcs and multi-edges; they are ignored in the input file.

Nodes, edges and graphs may have a URL attribute. In certain output formats (`ps2`, `imap`, `ismap`, `cmap`, or `svg`), this information is integrated in the output so that nodes, edges and clusters become active links when displayed with the appropriate tools. Typically, URLs attached to top-level graphs serve as base URLs, supporting relative URLs on components. When the output format is `imap`, or `cmap`, a similar processing takes place with the `headURL` and `tailURL` attributes.

For certain formats (`ps`, `fig`, `mif`, `mp`, `vtx` or `svg`), `comment` attributes can be used to embed human-readable notations in the output.

## 6 Conclusions

*dot* produces pleasing hierarchical drawings and can be applied in many settings.

Since the basic algorithms of *dot* work well, we have a good basis for further research into problems such as methods for drawing large graphs and on-line (animated) graph drawing.

## 7 Acknowledgments

We thank Phong Vo for his advice about graph drawing algorithms and programming. The graph library uses Phong's splay tree dictionary library. Also, the users of *dag*, the predecessor of *dot*, gave us many good suggestions. Guy Jacobson and Randy Hackbarth reviewed earlier drafts of this manual, and Emden contributed substantially to the current revision. John Ellson wrote the generalized polygon shape and spent considerable effort to make it robust and efficient. He also wrote the GIF and ISMAP generators and other tools to bring *graphviz* to the web.



## References

- [Car80] M. Carpano. Automatic display of hierarchized graphs for computer aided decision analysis. *IEEE Transactions on Software Engineering*, SE-12(4):538–546, April 1980.
- [GKNV93] Emden R. Gansner, Eleftherios Koutsofios, Stephen C. North, and Kiem-Phong Vo. A Technique for Drawing Directed Graphs. *IEEE Trans. Software Eng.*, 19(3):214–230, May 1993.
- [New89] Frances J. Newbery. Edge Concentration: A Method for Clustering Directed Graphs. In *2nd International Workshop on Software Configuration Management*, pages 76–85, October 1989. Published as *ACM SIGSOFT Software Engineering Notes*, vol. 17, no. 7, November 1989.
- [Nor92] Stephen C. North. Neato User's Guide. Technical Report 59113-921014-14TM, AT&T Bell Laboratories, Murray Hill, NJ, 1992.
- [STT81] K. Sugiyama, S. Tagawa, and M. Toda. Methods for Visual Understanding of Hierarchical System Structures. *IEEE Transactions on Systems, Man, and Cybernetics*, SMC-11(2):109–125, February 1981.
- [War77] John Warfield. Crossing Theory and Hierarchy Mapping. *IEEE Transactions on Systems, Man, and Cybernetics*, SMC-7(7):505–523, July 1977.

## A Graph File Grammar

The following is an abstract grammar for the *DOT* language. Terminals are shown in bold font and nonterminals in italics. Literal characters are given in single quotes. Parentheses ( and ) indicate grouping when needed. Square brackets [ and ] enclose optional items. Vertical bars | separate alternatives.

<i>graph</i>	→	[ <b>strict</b> ] ( <b>digraph</b>   <b>graph</b> ) <i>id</i> '{' <i>stmt-list</i> '}'
<i>stmt-list</i>	→	[ <i>stmt</i> ';' ] [ <i>stmt-list</i> ]
<i>stmt</i>	→	<i>attr-stmt</i>   <i>node-stmt</i>   <i>edge-stmt</i>   <i>subgraph</i>   <i>id</i> '=' <i>id</i>
<i>attr-stmt</i>	→	( <b>graph</b>   <b>node</b>   <b>edge</b> ) <i>attr-list</i>
<i>attr-list</i>	→	'[' <i>a-list</i> ']' [ <i>attr-list</i> ]
<i>a-list</i>	→	<i>id</i> '=' <i>id</i> [';'] [ <i>a-list</i> ]
<i>node-stmt</i>	→	<i>node-id</i> [ <i>attr-list</i> ]
<i>node-id</i>	→	<i>id</i> [ <i>port</i> ]
<i>port</i>	→	<i>port-location</i> [ <i>port-angle</i> ]   <i>port-angle</i> [ <i>port-location</i> ]
<i>port-location</i>	→	':' <i>id</i>   ':' ' (' <i>id</i> ; <i>id</i> )'
<i>port-angle</i>	→	'@' <i>id</i>
<i>edge-stmt</i>	→	( <i>node-id</i>   <i>subgraph</i> ) <i>edgeRHS</i> [ <i>attr-list</i> ]
<i>edgeRHS</i>	→	<i>edgeop</i> ( <i>node-id</i>   <i>subgraph</i> ) [ <i>edgeRHS</i> ]
<i>subgraph</i>	→	[ <b>subgraph</b> <i>id</i> ] '{' <i>stmt-list</i> '}'   <b>subgraph</b> <i>id</i>

An *id* is any alphanumeric string not beginning with a digit, but possibly including underscores; or a number; or any quoted string possibly containing escaped quotes.

An *edgeop* is -> in directed graphs and -- in undirected graphs.

The language supports C++-style comments: /\* \*/ and //.

Semicolons aid readability but are not required except in the rare case that a named subgraph with no body immediate precedes an anonymous subgraph, because under precedence rules this sequence is parsed as a subgraph with a heading and a body.

Complex attribute values may contain characters, such as commas and white space, which are used in parsing the *DOT* language. To avoid getting a parsing error, such values need to be enclosed in double quotes.

## B Plain Output File Format (-Tplain)

The “plain” output format of *dot* lists node and edge information in a simple, line-oriented style which is easy to parse by front-end components. All coordinates and lengths are unscaled and in inches.

The first line is:

```
graph scalefactor width height
```

The *width* and *height* values give the width and the height of the drawing; the lower-left corner of the drawing is at the origin. The *scalefactor* indicates how much to scale all coordinates in the final drawing.

The next group of lines lists the nodes in the format:

```
node name x y xsize ysize label style shape color fillcolor
```

The *name* is a unique identifier. If it contains whitespace or punctuation, it is quoted. The *x* and *y* values give the coordinates of the center of the node; the *width* and *height* give the width and the height. The remaining parameters provide the node's *label*, *style*, *shape*, *color* and *fillcolor* attributes, respectively. If the node does not have a *style* attribute, "solid" is used.

The next group of lines lists edges:

```
edge tail head n x1 y1 x2 y2 . . . xn yn [ label lx ly ] style color
```

*n* is the number of coordinate pairs that follow as B-spline control points. If the edge is labeled, then the label text and coordinates are listed next. The edge description is completed by the edge's *style* and *color*. As with nodes, if a *style* is not defined, "solid" is used.

The last line is always:

```
stop
```

## C Attributed DOT Format (-Tdot)

This is the default output format. It reproduces the input, along with layout information for the graph. Coordinate values increase up and to the right. Positions are represented by two integers separated by a comma, representing the  $X$  and  $Y$  coordinates of the location specified in points ( $1/72$  of an inch). A position refers to the center of its associated object. Lengths are given in inches.

A `bb` attribute is attached to the graph, specifying the bounding box of the drawing. If the graph has a label, its position is specified by the `lp` attribute.

Each node gets `pos`, `width` and `height` attributes. If the node is a record, the record rectangles are given in the `rects` attribute. If the node is polygonal and the `vertices` attribute is defined in the input graph, this attribute contains the vertices of the node. The number of points produced for circles and ellipses is governed by the `samplepoints` attribute.

Every edge is assigned a `pos` attribute, which consists of a list of  $3n + 1$  locations. These are B-spline control points: points  $p_0, p_1, p_2, p_3$  are the first Bezier spline,  $p_3, p_4, p_5, p_6$  are the second, etc. Currently, edge points are listed top-to-bottom (or left-to-right) regardless of the orientation of the edge. This may change.

In the `pos` attribute, the list of control points might be preceded by a start point  $p_s$  and/or an end point  $p_e$ . These have the usual position representation with a "s," or "e," prefix, respectively. A start point is present if there is an arrow at  $p_0$ . In this case, the arrow is from  $p_0$  to  $p_s$ , where  $p_s$  is actually on the node's boundary. The length and direction of the arrowhead is given by the vector  $(p_s - p_0)$ . If there is no arrow,  $p_0$  is on the node's boundary. Similarly, the point  $p_e$  designates an arrow at the other end of the edge, connecting to the last spline point.

If the edge has a label, the label position is given in `lp`.

## D Layers

*dot* has a feature for drawing parts of a single diagram on a sequence of overlapping “layers.” Typically the layers are overhead transparencies. To activate this feature, one must set the top-level graph’s `layers` attribute to a list of identifiers. A node or edge can then be assigned to a layer or range of layers using its `layer` attribute.. `all` is a reserved name for all layers (and can be used at either end of a range, e.g `design:all` or `all:code`). For example:

```
layers = "spec:design:code:debug:ship";
node90 [layer = "code"];
node91 [layer = "design:debug"];
node90 -> node91 [layer = "all"];
node92 [layer = "all:code"];
```

In this graph, `node91` is in layers `design`, `code` and `debug`, while `node92` is in layers `spec`, `design` and `code`.

In a layered graph, if a node or edge has no layer assignment, but incident edges or nodes do, then its layer specification is inferred from these. To change the default so that nodes and edges with no layer appear on all layers, insert near the beginning of the graph file:

```
node [layer=all];
edge [layer=all];
```

There is currently no way to specify a set of layers that are not a continuous range.

When PostScript output is selected, the color sequence for layers is set in the array `layercolorseq`. This array is indexed starting from 1, and every element must be a 3-element array which can interpreted as a color coordinate. The adventurous may learn further from reading *dot*’s PostScript output.

## E Node Shapes



box

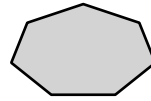

polygon

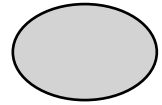

ellipse



point



egg



triangle

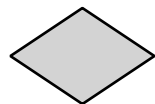

diamond

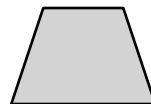

trapezium

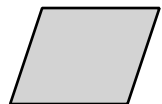

parallelogram

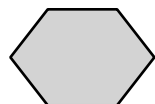

hexagon

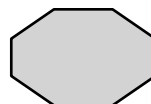

octagon

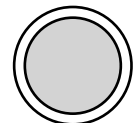

doublecircle

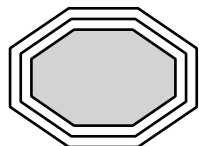

tripleoctagon

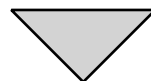

invtriangle

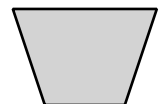

invtrapezium

## F Arrowhead Types

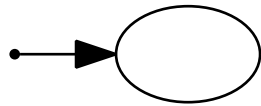

normal

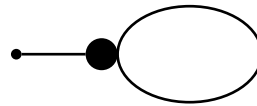

dot

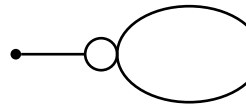

odot

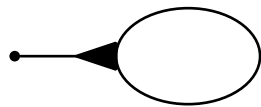

inv

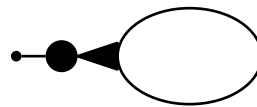

invdot

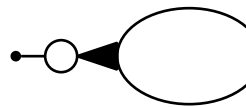

invodot

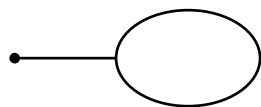

none

## G Color Names

### Whites

antiquewhite[1-4]  
 azure[1-4]  
 bisque[1-4]  
 blanchedalmond  
 cornsilk[1-4]  
 floralwhite  
 gainsboro  
 ghostwhite  
 honeydew[1-4]  
 ivory[1-4]  
 lavender  
 lavenderblush[1-4]  
 lemonghiffon[1-4]  
 linen  
 mintcream  
 mistyrose[1-4]  
 moccasin  
 navajowhite[1-4]  
 oldlace  
 papayawhip  
 peachpuff[1-4]  
 seashell[1-4]  
 snow[1-4]  
 thistle[1-4]  
 wheat[1-4]  
 white  
 whitesmoke

### Greys

darkslategray[1-4]  
 dimgray  
 gray  
 gray[0-100]  
 lightgray  
 lightslategray  
 slategray[1-4]

### Blacks

black

### Reds

coral[1-4]  
 crimson  
 darksalmon  
 deeppink[1-4]  
 firebrick[1-4]  
 hotpink[1-4]  
 indianred[1-4]  
 lightpink[1-4]  
 lightsalmon[1-4]  
 maroon[1-4]  
 mediumvioletred  
 orangered[1-4]  
 palevioletred[1-4]  
 pink[1-4]  
 red[1-4]  
 salmon[1-4]  
 tomato[1-4]  
 violetred[1-4]

### Browns

beige  
 brown[1-4]  
 burlywood[1-4]  
 chocolate[1-4]  
 darkkhaki  
 khaki[1-4]  
 peru  
 rosybrown[1-4]  
 saddlebrown  
 sandybrown  
 sienna[1-4]  
 tan[1-4]

### Oranges

darkorange[1-4]  
 orange[1-4]  
 orangered[1-4]

### Yellows

darkgoldenrod[1-4]  
 gold[1-4]  
 goldenrod[1-4]  
 greenyellow  
 lightgoldenrod[1-4]  
 lightgoldenrodyellow  
 lightyellow[1-4]  
 palegoldenrod  
 yellow[1-4]  
 yellowgreen

### Greens

chartreuse[1-4]  
 darkgreen  
 darkolivegreen[1-4]  
 darkseagreen[1-4]  
 forestgreen  
 green[1-4]  
 greenyellow  
 lawngreen  
 lightseagreen  
 limegreen  
 mediumseagreen  
 mediumspringgreen  
 mintcream  
 olivedrab[1-4]  
 palegreen[1-4]  
 seagreen[1-4]  
 springgreen[1-4]  
 yellowgreen

### Cyans

aquamarine[1-4]  
 cyan[1-4]  
 darkturquoise  
 lightcyan[1-4]  
 mediumaquamarine  
 medianturquoise  
 paleturquoise[1-4]

turquoise[1-4]

### Blues

aliceblue  
 blue[1-4]  
 blueviolet  
 cadetblue[1-4]  
 cornflowerblue  
 darkslateblue  
 deepskyblue[1-4]  
 dodgerblue[1-4]  
 indigo  
 lightblue[1-4]  
 lightskyblue[1-4]  
 lightslateblue[1-4]  
 mediumblue  
 mediumslateblue  
 midnightblue  
 navy  
 navyblue  
 powderblue  
 royalblue[1-4]  
 skyblue[1-4]  
 slateblue[1-4]  
 steelblue[1-4]

### Magentas

blueviolet  
 darkorchid[1-4]  
 darkviolet  
 magenta[1-4]  
 mediumorchid[1-4]  
 mediumpurple[1-4]  
 mediumvioletred  
 orchid[1-4]  
 palevioletred[1-4]  
 plum[1-4]  
 purple[1-4]  
 violet  
 violetred[1-4]