

Efficacy of Gravity-Fed Chlorination System for Community-Scale Water Disinfection in Northern Ghana

By

Daniel Cash Fitzpatrick

B.S. Environmental Engineering
California Polytechnic State University, 2007

Submitted to the Department of Civil and Environmental Engineering
In Partial Fulfillment of the Requirements of the Degree of

MASTER OF ENGINEERING
in Civil and Environmental Engineering
at the

MASSACHUSETTS INSTITUTE OF TECHNOLOGY

June 2008

© 2008 Daniel Cash Fitzpatrick
All rights reserved.

The author hereby grants to MIT permission to reproduce and to distribute publicly paper and electronic copies of this thesis document in whole or in part in any medium now known or hereafter created.

Signature of Author _____

Daniel Cash Fitzpatrick
Department of Civil and Environmental Engineering
May 9, 2008

Certified by _____

Susan Murcott
Senior Lecturer of Civil and Environmental Engineering
Thesis Supervisor

Accepted by _____

Daniele Veneziano
Chairman, Departmental Committee for Graduate Students

EFFICACY OF GRAVITY-FED CHLORINATION SYSTEM FOR COMMUNITY-SCALE WATER DISINFECTION IN NORTHERN GHANA

By
Daniel Cash Fitzpatrick

Submitted to the Department of Civil and Environmental Engineering on May 9, 2008 in
Partial Fulfillment of the Requirements for the Degree of Master of Engineering in Civil
and Environmental Engineering

ABSTRACT

Although chlorine is one of the lowest cost ways of providing disinfection, currently billions of people lack drinking water that has had this simple treatment. Arch Chemical's Pulsar 1 unit is an innovation in chlorine dosing in that it is a gravity-fed system which does not require electricity while providing relatively accurate dosing. The purpose of this study is to investigate the technical feasibility of the Pulsar 1 unit using high-test hypochlorite (HTH) as a viable chlorination option for community-scale drinking water disinfection in Northern Region, Ghana.

In addition, this study compares the Pulsar 1 unit to the household treatment of the *Kosim* filter plus Aquatabs. The *Kosim* filter is a pot-shaped Potters for Peace-type ceramic water available in Northern Ghana, while Aquatabs are an alternate chlorine product comprised of sodium dichloroisocyanurate (NaDCC).

A pilot study done in Mali in 2005 by EAU Lambda showed the Pulsar's potential to correctly dose a piped water supply with a flow rate of approximately 42 gpm (9.6 m³/hr). The present pilot study has evaluated the Pulsar system in Ghana and Cambridge, MA at flow rates of 18 gpm (4.1 m³/hr) and 9 gpm (2.0 m³/hr), respectively. This was challenging because the Pulsar was designed for swimming pool applications and thus chlorinated at levels higher than appropriate drinking water. As a result, several modifications were made to lower the chlorine concentrations from the Pulsar system into the appropriate drinking water range.

Both the Pulsar 1 and Aquatabs systems were found to be technically feasible. The main two advantages of using the Pulsar system over Aquatabs are the vastly reduced operational costs (in \$/m³) of disinfection treatment (about 48 times cheaper) and its ability to reach an entire community (compared to just a single household). However, these benefits are gained as a tradeoff for increased system complexity and higher capital costs. Overall there is no "single best option", which means site-specific circumstances should dictate the appropriate technology.

Thesis Supervisor: Susan Murcott

Title: Senior Lecturer of Civil and Environmental Engineering

Acknowledgements

There are several people to thank or hold responsible for my year at MIT. The first few are Eric Adams, Pete Shanahan, and Susan Murcott who fortunately saw me as an appropriate addition to the Civil & Environmental Master's of Engineering Program.

Next is my thesis advisor, Susan Murcott, for all of her encouragement to join her research group and guidance in selecting an appropriate topic. The MEng program would not be what it is today without her continuing energy and extensive expertise in development work. I have yet to meet anyone more selfless in their love of helping others.

Several people contributed to my thesis research, but the one who continuously stood out is Dave Blanchette from Arch Chemicals. His advice, support, and provided materials were critical to the completion of my work. Laura Tew, also from Arch, was equally expeditious in assisting my many queries. It would be impossible for me to overstate the importance of their help in this project, which would likely have been impossible without their assistance.

My month in Ghana is an experience I will never forget. Part of what made it so wonderful is the research success I enjoyed, which could just as easily have been a constant source of stress and frustration. Certain individuals deserve much of the credit for this "smooth sailing", most notably Carl Allen and Kim Weaver. Both were working for the Peace Corps in Ghana, and their assistance was absolutely vital. Besides providing space for a lab and my on-site research, they were both extremely welcoming and always eager to get their hands dirty. Their work ethic and willingness to help is second to none.

While in Ghana, several of the Pure Home Water staff were also of great assistance. As outsiders coming into a foreign country, having locals who can endure your shortcomings while assisting with various logistics is truly indispensable. In particular, Peter Abaazan, Shakool Ibrahim, and Peter Alhassan all aided in various ways by providing cultural advice, transportation, and even how to have a good time.

I would also like to thank my fellow classmates who were forced to endure my presence for prolonged periods of time, including Izumi Kikkawa, Tamar Losleben, Vanessa Green, Andrew Swanton, and Matt Stevenson. They are all terrific people destined for great things.

Special thanks also go to PATH for their financial support.

Lastly I would like to thank my parents and brother for their never-ending support. Any successes I may enjoy are directly attributable to them. I cannot fathom how different my life would be without their love, advice, and support. Thank you for being such wonderful role models.

My many thanks to all the people mentioned above for your help. Any misconceptions, deficiencies, or errors are mine alone.

Table of Contents

Abstract.....	2
Acknowledgements.....	4
Table of Contents.....	5
List of Abbreviations.....	8
List of Figures.....	9
List of Tables.....	10
1.0 Introduction.....	11
1.1 Urgency for Clean Water.....	11
1.2 Ghana Background.....	12
1.2.1 Geography.....	12
1.2.2 Socioeconomic Status.....	13
1.2.3 Water Quality in Ghana.....	14
1.2.3.1 Microbial Contamination.....	16
1.2.3.2 Turbidity.....	17
1.2.3.3 Diarrhea.....	18
1.3 Various Chlorination Technologies both in Ghana and Abroad.....	18
1.3.1 The <i>Kosim</i> Filter.....	18
1.3.1.1 History.....	20
1.3.1.2 Use.....	21
1.3.1.3 Aquatabs.....	21
1.3.1.4 Medentech Background.....	22
1.3.1.5 Aquatabs Tablet Weight and Dosing Requirements.....	23
1.3.1.6 Aquatabs Use in Ghana.....	24
1.3.2 Community-Scale Chlorination Technology.....	25
1.3.2.1 Tap Water in Tamale, Ghana.....	25
1.3.2.2 Gravity Driven Chlorinators.....	25
1.3.2.3 Diffusion Chlorinators.....	27
1.3.2.4 Water-Powered Chlorinators.....	30
1.3.3 High-Test Hypochlorite (HTH).....	31
1.3.4 Selection of Arch Chemical’s Pulsar 1.....	32
1.3.4.1 History of Pulsar 1 Research in Mali.....	32
1.3.4.2 Design and Operation of the Pulsar 1.....	34
1.4 Research Objectives.....	36
1.4.1 General Objective.....	36
1.4.2 Specific Objectives.....	36
2.0 Water Disinfection Using Chlorine.....	37
2.1 Chlorine Chemistry.....	39
2.2 Breakpoint.....	39
2.3 Chlorine Dose.....	40
2.4 Disinfection By-Products.....	41
2.5 Chlorine Appropriate Situations.....	41
2.6 Analytical Methods.....	42
2.6.1 DPD Pocket Colorimeter II Method.....	44
2.6.2 DPD Titration Method.....	46

2.6.3 Hach Chlorine Test Strips Method	48
2.6.4 Other Non-Chlorine Testing Methods	49
3.0 Methodology of Testing Community-Scale Water Disinfection Using Chlorine	51
3.1 Field Study Background	51
3.2 Field Study Design and Methods	52
3.2.1 Site Selection	52
3.2.2 Field Site Source Water	53
3.2.3 Influent Turbidity, pH, and Chlorine Residuals	54
3.2.4 Chlorine Demand of Influent Water	55
3.2.5 Determining Flow-rate of the System	56
3.2.6 Effect of Runtime on Pulsar System	57
3.2.7 Modifications to Pulsar 1 Unit	58
3.2.7.1 Modifications Made in Ghana	58
3.2.7.2 Additional Adjustments Made While in Cambridge	60
4.0 Results & Analysis of Ghana Research	62
4.1 System Flow-Rates	62
4.2 Decay Rates of Chlorine Residual Over Time	62
4.3 Effect of Pulsar Runtime on Free Chlorine Residual	64
4.4 Effect of “Original” Dilution Nozzle Assembly (DNA) on Free Chlorine Residual ..	65
4.5 Effect of Ball Valve Modification on Chlorine Residual	65
5.0 Results & Analysis of Cambridge Lab Research	68
5.1 Cambridge Influent Water Parameters	68
5.2 Cambridge System Flow Rates	68
5.3 Effect of Pulsar Runtime and “Newer” Dilution Nozzle Assembly on Chlorine Residual	70
6.0 Discussion of Results	72
6.1 Community-Scale Potentials	72
6.2 Challenges to Implementation of Pulsar 1	73
6.2.1 Operational Challenges	73
6.2.2 Maintenance Challenges	74
6.2.3 Potential Hazards with Handling and Use of Calcium Hypochlorite	74
6.2.4 Sensitivity to Input Parameters	74
6.3 Study Limitations	75
7.0 Comparison of Pulsar 1 Unit to Aquatabs for Chlorination in Ghana	76
7.1 Cost of HTH and Aquatabs	76
7.2 Comparison of Water Disinfection Efficacy	77
7.3 Consumer Preference	77
7.3.1 Effect of Chlorine Taste on Consumer Preference	77
7.4 General Sustainability Comparison	78
8.0 Conclusions & Recommendations	81
8.1 Future Research	81
8.2 Pure Home Water	82
8.3 Arch Chemicals	82
9.0 References	83
10.0 Appendices	89
10.1 Relevant Conversion Tables for English & Metric	89

<i>10.2</i> Calculation of Net Present Value (NPV) Comparison for Pulsar 1 with HTH versus <i>Kosim</i> filter with Aquatabs	90
<i>10.3</i> Data Taken in Ghana	91
<i>10.4</i> Data Taken in Cambridge	100
<i>10.5</i> High-Test Hypochlorite (HTH) Material Data Safety Sheet (MSDS)	103
<i>10.6</i> Pulsar 1 Operator's Manual	113

List of Abbreviations

CFU	Colony Forming Unit
CWSA	Community Water and Sanitation Agency
DBP	Disinfection By-Product
DNA	Dilution Nozzle Assembly
DPD	Diethyl Paraphenylene Diamine
EPA	Environmental Protection Agency
ESV	Emergency Shutoff Valve
HAA	Haloacetic Acids
GDP	Gross Domestic Product
GPM	Gallons Per Minute
GSB	Ghana Standards Board
HTH	High-Test Hypochlorite
IMF	International Monetary Fund
IPA	Innovations for Poverty Action
ISO	International Organization for Standardization
MCL	Maximum Contaminant Level
MCLG	Maximum Contaminant Level Goal
MDG	Millennium Development Goals
MIT	Massachusetts Institute of Technology
NGO	Non Governmental Organization
NTU	Nephelometric Turbidity Units
PHW	Pure Home Water
PPM	Parts Per Million
RWP	Kenya Rural Water Project
TC	Total Coliform
THM	Trihalomethane
TSO	Tamale Sub Office
UN	United Nations
UNICEF	United Nations Children's Fund
WHO	World Health Organization

List of Figures

FIGURE 1: DISTRIBUTION OF THE WORLD POPULATION WITH AND WITHOUT ACCESS TO AN IMPROVED WATER SUPPLY IN URBAN AND RURAL AREAS IN 1990 AND 2004 (WHO/UNICEF 2006).....	11
FIGURE 2: PERCENTAGE OF THE WORLD POPULATION USING IMPROVED WATER SOURCES IN URBAN AND RURAL AREAS (UNITED NATIONS DEPARTMENT OF ECONOMIC AND SOCIAL AFFAIRS (UN-DESA) 2006).....	12
FIGURE 3: GEOGRAPHICAL LOCATION OF GHANA (FAO ACCESSED DEC 2007)	13
FIGURE 4: THE DISTRIBUTION OF INCOME IN GHANA AMONG 20% QUANTILES (EARTH TRENDS 2003).....	14
FIGURE 5: THE <i>KOSIM</i> FILTER AND ITS COMPONENTS (PFP, 2007).....	19
FIGURE 6: STRIP OF 10 AQUATABS.....	21
FIGURE 7: THE RWP INSTALLED CHLORINE DISPENSER IN KENYA (BERENS AND VAN DUSEN 2007)	26
FIGURE 8: CLOSE-UP OF CHLORINE DISPENSER AND JERRY CAN (BERENS AND VAN DUSEN 2007)	27
FIGURE 9: DESIGN OF A POT CHLORINATOR (WATER FOR THE WORLD 2007)	28
FIGURE 10: CTI-8 CHLORINATOR INSTALLED IN NICARAGUA (YAMANA AND NEPF 2003)	29
FIGURE 11: THE SANIKIT SYSTEM (TREVALINET 2006).....	29
FIGURE 12: ARCH CHEMICAL’S PULSAR 1 TECHNOLOGY (TREVALINET 2006).....	30
FIGURE 13: HIGH-TEST HYPOCHLORITE (HTH) CONTAINER AND BRIQUETTES FOR PULSAR 1 SYSTEM	31
FIGURE 14: PULSAR 1 INTERNAL FLOW DIAGRAM (BLANCHETTE 2006).....	34
FIGURE 15: PULSAR 1 INTERNAL PARTS DIAGRAM (ARCH CHEMICALS 2003A).....	35
FIGURE 16: WATERBORNE PATHOGENS AND THEIR SIGNIFICANCE IN WATER SUPPLIES (WHO 2006)	37
FIGURE 17: DISINFECTION (2 LOG) OF SELECTED MICROORGANISMS USING FREE AVAILABLE CHLORINE (FAC) (WHO 2004).....	38
FIGURE 18: TYPICAL BREAK-POINT CHLORINATION CURVE (METCALF & EDDY 2003).....	40
FIGURE 19: EFFECT OF pH ON PERCENT HOCL FORMATION (MEYER 2004).....	42
FIGURE 20: DPD REACTANTS AND PRODUCTS (HARP 1995).....	43
FIGURE 21: DPD COLOR WHEEL	44
FIGURE 22: DPD POCKET COLORIMETER II TEST UNIT (HACH 2008).....	45
FIGURE 23: POCKET COLORIMETER TESTING METHODOLOGY	46
FIGURE 24: DPD TITRATION	46
FIGURE 25: COMPARISON OF DPD TITRATION AND POCKET COLORIMETER II METHODS	48
FIGURE 26: HACH CHLORINE FOIL SINGLES	49
FIGURE 27: HACH pH TEST STRIPS USED	49
FIGURE 28: TURBIDITY TUBE USED	50
FIGURE 29: LOCATION OF TAMALE WITHIN GHANA (GLOBE MEDIA LIMITED 2007)	51
FIGURE 30: SOURCE WATER FROM ELEVATED TANK IN TAMALE.....	52
FIGURE 31: POSITION AND HEIGHT MEASUREMENTS OF ELEVATED TANK IN GHANA.....	53
FIGURE 32: PVC CONNECTIONS FROM ELEVATED TANK TO STORAGE TANK IN GHANA.....	54
FIGURE 33: LOCAL BOTTLED <i>VOLTIC</i> WATER AND BLEACH (3.5%) PRODUCTS USED IN GHANA.....	55
FIGURE 34: CHLORINE DEMAND COMPARISON OF TAP AND LOCAL BOTTLED WATER IN TAMALE.....	56
FIGURE 35: CONFIGURATION AND FLOW DIRECTION OF SYSTEM.....	57
FIGURE 36: MEASUREMENT LOCATION FOR ALL PULSAR DATA VALUES	58
FIGURE 37: DILUTION NOZZLE ASSEMBLY (DNA) ON PULSAR UNIT IN GHANA.....	59
FIGURE 38: LOCATION OF PULSAR INLET & OUTLET BALL VALVES	60
FIGURE 39: EMERGENCY SHUTOFF VALVE (ESV) & DILUTION NOZZLE ASSEMBLY (DNA) MODIFICATIONS TESTED IN CAMBRIDGE	61
FIGURE 40: FLOW-RATES FROM GRAVITY-FED TANK IN GHANA	62
FIGURE 41: FREE CHLORINE RESIDUAL VS. TIME (LOW CONCENTRATION BATCH)	63
FIGURE 42: FREE CHLORINE RESIDUAL VS. TIME (HIGH CONCENTRATION BATCH).....	63
FIGURE 43: EFFECT OF PULSAR RUNTIME ON FREE CHLORINE RESIDUAL CONCENTRATION	64
FIGURE 44: RANGE OF OUTPUT CONCENTRATIONS FROM THE DILUTION NOZZLE ASSEMBLY (DNA)	65
FIGURE 45: INLET BALL VALVE ORIENTATION VS. FLOW RATE	66
FIGURE 46: EFFECT OF INLET BALL VALVE ON CHLORINE RESIDUAL CONCENTRATION	66
FIGURE 47: INFLUENT TANK FOR PULSAR 1 SYSTEM AT MIT LAB IN CAMBRIDGE, MA.....	69
FIGURE 48: FLOW-RATES FROM GRAVITY-FED TANK IN CAMBRIDGE	69
FIGURE 49: CHLORINE RESIDUAL CONCENTRATIONS OVER TIME WITH “NEWER” PULSAR MODIFICATIONS IN CAMBRIDGE.....	70

FIGURE 50: CHLORINE RESIDUAL CONCENTRATIONS WITH MODIFIED DNA, SHOWN BY TRIAL	71
FIGURE 51: COST OF HTH & AQUATABS COMPARED TO OTHER DRINKING WATER OPTIONS (MURCOTT 2007c).....	76
FIGURE 52: NET PRESENT VALUE (NPV) COMPARISON OF PULSAR 1 + HTH VERSUS <i>KOSIM</i> + AQUATABS, NORMALIZED TO TREATMENT COST PER VOLUME	77
FIGURE 53: AQUATABS VARIABILITY OF FREE CHLORINE RESIDUAL IN GHANA (SWANTON 2008)	80

List of Tables

TABLE 1: WATER AND SANITATION IN GHANA IN 2000 COMPARED WITH MDG TARGETS FOR 2015 AND 2020 (AMPOMAH 2004).....	15
TABLE 2: PROGRESS MADE TOWARDS MEETING MDGs IN GHANA, MALI, AND NIGER (AMPOMAH 2004) .	15
TABLE 3: AVERAGE TURBIDITY OF DAMS IN NORTHERN REGION, GHANA (FORAN 2007), (JOHNSON 2007)	18
TABLE 4: CHEMICAL COMPOSITION OF AQUATABS BY WEIGHT (MEDENTECH LTD. 2001)	22
TABLE 5: AQUATABS AND DOSAGES (MEDENTECH LTD. 2007B).....	23
TABLE 6: AMOUNT OF HTH USED BASED ON TREATMENT LEVEL (ARCH CHEMICALS ACCESSED 2008)	33
TABLE 7: COMPARISON OF ANALYTICAL METHODS FOR CHLORINE ((HARP 1995)).....	43
TABLE 8: LAB MATERIALS NEEDED FOR DPD POCKET COLORIMETER II TEST	45
TABLE 9: LAB MATERIALS NEEDED FOR DPD TITRATION TEST	47
TABLE 10: WATER QUALITY OF TAMALE MUNICIPALLY PIPED WATER AT PEACE CORPS OFFICE.....	54
TABLE 11: CHLORINE OUTPUTS FOR 1/4" RAISED GRID BASED ON FLOW RATE (BLANCHETTE 2007A).....	59
TABLE 12: WATER QUALITY OF TAP WATER AT MIT LAB IN CAMBRIDGE, MA COMPARED TO GHANA.....	68
TABLE 13: GENERAL SUSTAINABILITY COMPARISON OF CHLORINATION SYSTEMS	79

1.0 Introduction

1.1 Urgency for Clean Water

Statistics from 2004 indicate that 1.1 billion people currently lack access to an improved water supply. Improved water supply is defined by the Joint Monitoring Program (JMP, a collaboration of the World Health Organization (WHO) and the United Nation's Children's Fund (UNICEF)) as the availability of at least 20 L of water per person from an improved water source within 1 km of that person's dwelling (WHO/UNICEF, 2007). Improved water sources include protected springs, boreholes, household standpipes, etc., which provide safe, clean water. Further, the majority of these 1.1 billion people reside in either Asia or Africa, with 2 of 5 Africans lacking access to an improved water supply.

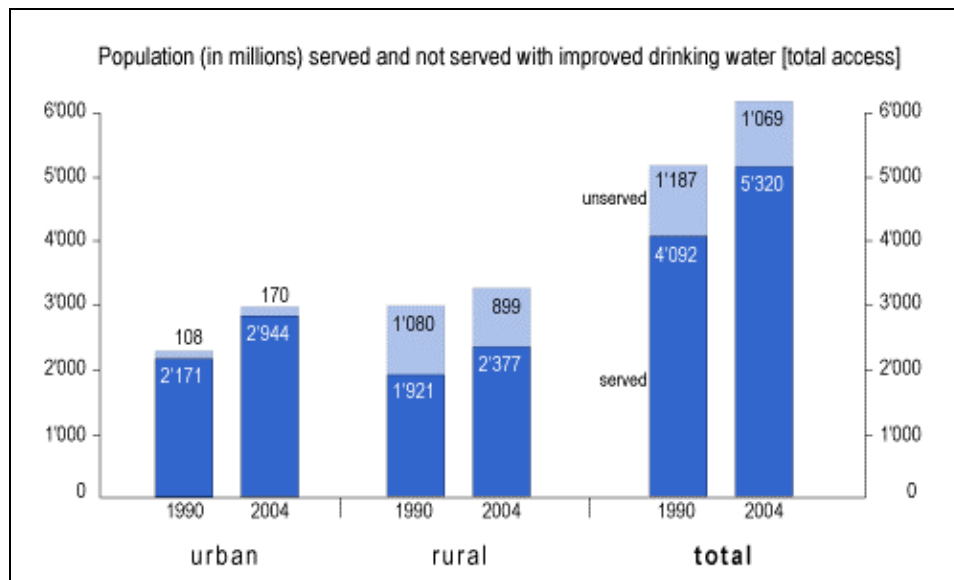

Figure 1: Distribution of the World Population With and Without Access to an Improved Water Supply in Urban and Rural Areas in 1990 and 2004 (WHO/UNICEF 2006)

Figure 1 indicates that the percentage of people with access to an improved water supply has risen from 78% in 1990 to 83% in 2004. While this shows an improvement, 17% of the world's population is still in need. Furthermore, 1.3 to 2.0 billion people are currently without access to safe drinking water (water that is below government water quality limits) (Smith, 2008).

Waterborne diseases (diarrhea, typhoid, etc.) are just one of the many effects of this glaring issue. Currently, there are four billion cases of diarrhea per year worldwide, resulting in 1.8 million deaths (90% of which are amongst children under five years old) (WHO/UNICEF, 2006). Furthermore, statistics show that 10 million people die each year from cholera, typhoid, dysentery and other diarrheal diseases caused by poor sanitation.

Members of the United Nations (UN) assembly met from September 6th-8th, 2000 to address these issues. The result was the development of the UN Millennium Development Goals (MDGs), a set of eight goals aimed at meeting the basic needs of the worldwide population. The seventh goal details the need to ensure environmental sustainability (UN, 2005). A subset of this goal, Target 10, is to reduce by half the proportion of people without sustainable access to safe drinking water by 2015 (UN-NLGS, 2007). A 2006 report released by the UN shows that there is still significant work that needs to be done to achieve this goal.

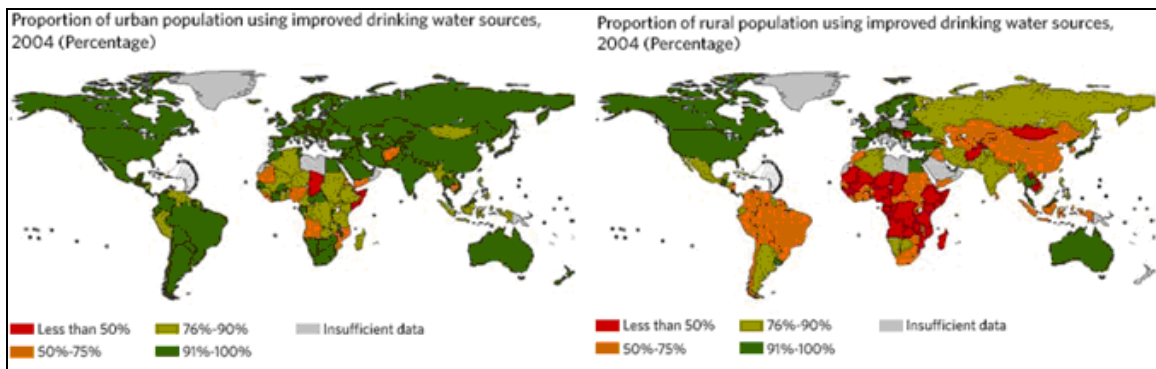

Figure 2: Percentage of the World Population Using Improved Water Sources in Urban and Rural Areas (United Nations Department of Economic and Social Affairs (UN-DESA) 2006)

Additionally, the 4th Millennium Development Goal is to reduce child mortality. Specifically, this goal aims to reduce by two thirds the child mortality rate amongst children under five. Seeing as how diarrhea accounts for roughly 1.6 million deaths among children under five, the eradication of this disease is important (UN, 2005). In order to do this, progress must be made to enhance water and sanitation in the developing world.

1.2 Ghana Background

1.2.1 Geography

The Republic of Ghana is located in Western Africa. It borders Togo to the East, Burkina Faso to the north, Côte d'Ivoire to the west, and the Gulf of Guinea to the south.



Figure 3: Geographical Location of Ghana (FAO Accessed Dec 2007)

Ghana has a land area of 239,460 sq km, which is slightly smaller than the state of Oregon and roughly the same size as the United Kingdom (About, Inc., 2007). The climate is varied across the country, but primarily tropical. In the southeast it is warm and dry, contrasted by hot and humid conditions in the southwest. In the north, the climate is hot and dry (World Factbook, 2007). The rainfall trends are seasonal. In the south there are two rainy seasons; May-June and August-September (IMF, 2006). In the north there is just one rainy season, beginning in May or June and ending in September or October (BBC, 1997).

There are roughly 21 million people in Ghana, with a median age of 20 years (About, Inc., 2007). In 2007, the infant mortality rate was 54 deaths per 1,000 live births. This is a better rate than the countries neighboring Ghana: Burkina Faso, Côte d'Ivoire, and Togo have infant mortality rates of 90, 87, and 59 deaths per 1,000 live births, respectively (CIA, 2008). However, the infant mortality rate in Northern Ghana is 154 deaths per 1,000 live births (GSS, 2004). Additionally, Ghana joins many of its African neighbors as having one of the worst life expectancy rates in the world, 59 years (World Factbook, 2007).

1.2.2 Socioeconomic Status

Ghana has a number of valuable natural resources (namely gold, timber and cocoa). As a result, a large component of Ghana's economy is governed by foreign exchange. Despite these resources, a 1992 estimate indicated that 31.4% of Ghanians are below the poverty line (About, Inc., 2007).

A standard means of calculating a nation's worth is to sum the value of that nation's goods and services produced for one year. This calculation is what is known as the Gross Domestic Product (GDP). In 2006, the International Monetary Fund (IMF) calculated Ghana's GDP to be US \$59.4 billion, compared to a GDP of US \$13,020.9 for the US. This places Ghana 74th out of the 179 nations assessed in 2006. Nations with similar GDPs include Guatemala, Uzbekistan, and Kuwait (IMF, 2006).

The distribution of wealth in Ghana is also of note. One statistic that measures the distribution of income is known as the Gini Index. If a country has perfect distribution (everyone makes the same amount of money) the Gini Index will be 0, whereas if there is perfect inequality amongst incomes the Gini Index will be 100. The Gini Index for Ghana is 41 (Earth Trends, 2003). This is the same Gini Index as the US.

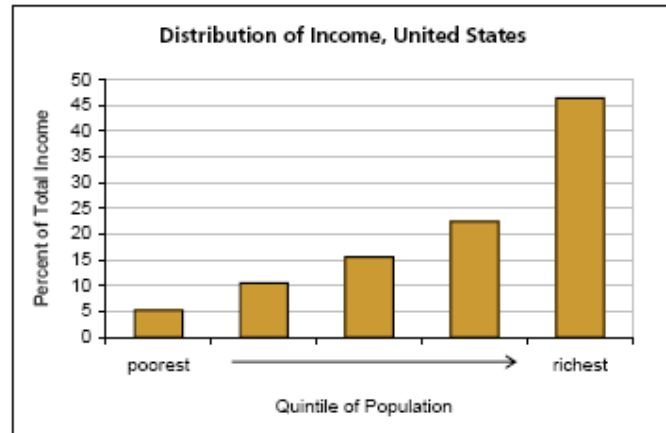

Figure 4: The Distribution of Income in Ghana Among 20% Quintiles (Earth Trends 2003)

Additionally, 45% of the population lives on less than US \$1 US per day and 79% of the population lives on less than US \$2 per day (Earth Trends 2003).

1.2.3 Water Quality in Ghana

Master of Engineering (MEng) MIT student Sophie Johnson conducted a survey in Northern Region, Ghana in 2007 that indicates that 0% of traditional households always have access to improved water or sanitation (Johnson, 2007). But among modern households, 83% always have access to an improved water source, and 100% always have access to improved sanitation. Traditional (rural) households are of mud-brick construction with thatch roofs and dirt floors. Modern (urban) households are of concrete or brick construction with concrete floors and tin or tile roofs. Another study reports that 88% of urban populations are using improved drinking water sources, compared with only 64% of rural populations (UNICEF, 2004). Table 1 shows the state of water and sanitation in Ghana in 2000, and what the MDG's aim to achieve by 2015.

Table 1: Water and Sanitation in Ghana in 2000 Compared with MDG Targets for 2015 and 2020 (Ampomah 2004)

		2000			MDG - 2015		
		Pop (m)	Access (m)	Access (%)	Pop (m)	Access (m)	Access (%)
Water (MDG 2015)	Rural	11.8	5.2	44%	17.1	12.5	73%
	Urban	8.4	5.1	61%	13	11.4	88%
	Total	20.2	10.3	51%	30.1	23.9	79%
Sanitation (MDG 2020)	Rural	11.8	1.3	11%	19.3	10.8	56%
	Urban	8.4	3.4	40%	15.1	12.1	80%
	Total	20.2	4.7	23%	34.4	22.9	67%

Table 2: Progress Made Towards Meeting MDGs in Ghana, Mali, and Niger (Ampomah 2004)

Country	Goal 1 Eradicate extreme poverty and hunger	Goal 4 Reduce child mortality	Goal 7 Ensure environmental sustainability	
	Target Halve the proportion of people suffering from hunger	Target Reduce under five and infant mortality rates by two-thirds	Target Halve the proportion of people without sustainable access to improved water and basic sanitation	
	Undernourished people (as % of total pop)	Under-five mortality rate (Per 1,000 live births)	Population with improved access to water sources (%)	Population with improved access to basic sanitation (%)
Ghana	On track	Off track	Off track	Off track
Mali	Off track	Off track	On track	Off track
Niger	Off track	Off track	Off track	Off track

It is clear from Table 2 that if the conditions continue to progress in the same manner as they have to date, the MDG targets for improved access to water and basic sanitation (among others) will not be reached for Ghana.

1.2.3.1 Microbial Contamination

In the WHO's Guidelines for Drinking Water Quality, the first priority for drinking water is to "ensure an adequate supply of microbially safe water" (WHO, 2004).

The presence of pathogenic bacteria in drinking water is typically due to fecal contamination. However, it is generally difficult to measure fecal contamination. As a result, non-pathogenic and easily detectable microorganisms are used as indicators of fecal contamination in drinking water. One means of doing this is to measure the total coliform (TC) count. Coliforms are among the 1% of bacteria that are capable of forming colonies. TCs are non-pathogenic, but their presence indicates microbial contamination. The standard unit of measure for reporting TC contamination is the total number of colony forming units (CFU) per 100 mL. The EPA approved the use of TC as a microbial indicator in 1986 when they passed the Safe Drinking Water Act (Gallagher, 1996). The WHO Guidelines for Drinking Water Quality 3rd Edition (2006) refers to TC as appropriate for evaluating drinking water treatment system performance (WHO, 2004). The Ghana Standards Board (GSB) requires that TC concentrations in drinking water be 0 CFU/100 mL (GSB, 1998).

Another means of measuring bacterial contamination is to measure the *Escherichia coli* (EC) count. EC is a bacteria present in feces. In human defecate there may be as many as 10 trillion EC bacteria microorganisms. Due to EC's origin in feces, the presence of EC has typically been used to indicate fecal contamination of water sources. EC concentration is a subset of the TC concentration, so according to the GSB, there should be 0 CFU/100 mL of EC present in drinking water.

MIT Master of Engineering (MEng) students Rachel Peletz and Sophie Johnson conducted an epidemiological study on water quality conditions in Northern Region, Ghana in 2006 and 2007, respectively. During the study, both students took water samples from a combination of traditional and modern households. The drinking water sources among the households surveyed included household taps, standpipes, boreholes, and dugouts. In Peletz's research, the primary and secondary drinking water sources were boreholes and dugouts, respectively. From 24 samples, 100% tested positive for TC, with an average TC concentration of 3,000 CFU/100mL (Peletz, 2006). Peletz's results also show that 71% of the samples taken tested positive for EC, with an average of 50 CFU/100mL. Johnson's research indicated an average TC concentration of 23,000 CFU/100mL among traditional homes, which primarily used dugouts for water collection, and 1,500 CFU/100mL among modern homes, which primarily used household taps or standpipes for water collection (Johnson, 2007). Similarly, Johnson's results indicate that the average EC count is 690 CFU/100mL in traditional homes, and 1.4 CFU/100mL in modern homes (Johnson, 2007).

1.2.3.2 Turbidity

Turbidity is a measure of the cloudiness of a water sample, as a result of suspended and colloidal solids. This cloudiness originates from phytoplankton, resuspension of sediments, urban runoff, sediments from erosion, algae growth, and waste discharge. The reason that high levels of turbidity is a health concern is that contaminants like bacteria and virus attach to the particles. Once the bacteria or virus attaches to the particles, it is more difficult to disinfect the water via chlorination or other methods, because the solid acts as a shield for the contaminant.

A Nephelometer is the standard device used to measure turbidity, which provides a unit of measure in Nephelometric Turbidity Units (NTU). This device shines a light through a water sample and measures the intensity of light that scatters at a 90° angle from the source beam. The more suspended solids in the water sample, the more scattering, and the higher the turbidity. Using a turbidity tube, the turbidity is reported in Turbidity Units (TU). The GSB sets a maximum turbidity in drinking water of 5 NTU (GSB, 1998). A turbidity of 5 NTU represents the point at which the turbidity becomes visible to the naked eye (WHO 2004). The WHO does not set a guideline for the maximum turbidity level, however, a value of 0.1 NTU is recommended for disinfection purposes (WHO, 2004). As a basis of comparison, as of 2002 the US water quality standard for turbidity is a maximum of 1 NTU. Additionally, 95% of the daily samples must not exceed 0.3 NTU in any given month (USEPA 2005).

In Northern Region, Ghana, 1 million of the 1.8 million people drink water from unimproved sources, one of the most common of which is dams (or dugouts) (GSS, 2004). Dams are excavated, structures, which store water that precipitates during the rainy season and that flows from intermittent streams. Some of these dams dry out due to the long duration of the dry season (9 months), forcing community members to travel long distances to collect water from other sources.

A major health concern associated with these dams is that they are highly turbid. Former MIT Meng student Melinda Foran performed turbidity tests on eleven dams during the rainy season in 2007. The average turbidity value of the dams tested was 690 TU, with a median of 300 TU (Foran 2007). Additionally, some of the dams had turbidity values as high as 2,000 TU. These turbidity tests were performed at the dams themselves, so there was no time for the particles to settle. Johnson performed turbidity tests on stored, pre-treatment water samples during the dry season (2007). Because these samples were taken from household storage containers, the time that passed between water collection and sampling likely allowed the settling of particles. From 33 different rural households, which primarily used dams as their water source, Johnson calculated an average turbidity of 190 NTU (Johnson 2007).

Table 3: Average Turbidity of Dams in Northern Region, Ghana (Foran 2007), (Johnson 2007)

Season	Sampling Location	Number of Samples	Average Turbidity
Rainy	Direct From Dams	11	690 TU
Dry	Storage Containers in Households	33	190 NTU

1.2.3.3 Diarrhea

Because many of the primary water sources in Northern Region, Ghana are unimproved and microbially contaminated, Peletz investigated the correlation between the use of improved water sources and the prevalence of diarrhea. Among households surveyed where at least one person had diarrhea, 10% of people had diarrhea, while of those same households only 47% always used improved water sources. On the other hand, among household where there was no diarrheal disease, 74% of those households always used improved water sources (Peletz 2006).

1.3 Various Chlorination Technologies both in Ghana and Abroad

The historically high occurrences of typhoid, dysentery, and cholera greatly influenced the 19th century sanitary revolution, an essential component of which was the beginning of widespread chlorination of public drinking water supplies in the West. Chlorine is often the preferred disinfectant of choice because of its effectiveness, efficiency, cost, convenience, and benefits of having a residual concentration. Treatment methods usually require minimum concentrations and contact times in order to be successful. Chlorine has also become a viable alternative for taste and odor control, algae and slime control, and water-main disinfection ((M20 Manual of Water Supply Practices 2006)). Other options such as ozone or ultraviolet disinfection are often less appropriate because they can require expensive equipment which is often unavailable. Iodine is also a common disinfection mechanism, but is often not used on a community-scale because organizations such as the WHO do not recommend its use for prolonged periods of time because of its possible health effects on thyroid (WHO 2003).

One of the key distinguishing factors in choosing an appropriate chlorine technique is to understand the scale at which disinfection will occur. The scale ranges from household to community to centralized, and the types of technologies within each are potentially different. In this thesis, two chlorination technologies which function at two different levels (household and community) are considered.

1.3.1 The Kosim Filter

The ceramic pot Filtron filter is locally in Ghana by Ceramic Tamakloe Ltd. and distributed in the Northern sector of Ghana by Pure Home Water (PHW). The *Kosim* filter is a ceramic water filter impregnated with colloidal silver. It relies on gravity to filter water through porous clay and is shaped in the form of a flower pot. It is 31 cm in diameter, 24 cm high, and holds 8-8.5 L of water when full (Jackson and Murcott 2007). The top of the filter rests on a plastic ring that fits on top of the plastic storage receptacle, which the filtered water is collected in. The storage receptacles are 50 L clear, plastic buckets. Some advantages associated with the use of plastic receptacles include ease of storage, shipping and handling, and cleaning. Other components of the filter unit include a plastic spigot connected to the bottom of the receptacle, and a plastic or ceramic lid for the top of the filter and receptacle.



Figure 5: The *Kosim* Filter and its components (PFP, 2007).

The ceramic filter, storage receptacle, lid and ring are all made in Ghana, while the spigots are imported. The sales and distribution of *Kosim* filters in Northern Region district capitol of Tamale. They have three full-time and two part-time employees who are responsible for contacting communities, making community presentations, and selling the *Kosim* filters to consumers in and around Tamale. For rural sales, when PHW contacts a new community to sell *Kosim* filters, they first contact the village chief and/or the village volunteer. Each community has a village volunteer, who is responsible for keeping records of the people in the community, organizing village events (feasts for newborns, funerals, etc.), and other tasks. This meeting leads to a community wide demonstrative training about the use of the *Kosim* filter, which is led by a PHW sales specialist. The specialists are native to this particular region and speak the local language. After the presentation, the village volunteer gathers a list of all the people who want to purchase a filter. They are also responsible for collecting money for the filters. In return, the village volunteer is rewarded with a Ghana Cedi (GHC) 1 (equivalent to US \$1) commission for the sale of each filter. Once a list has been created and the appropriate money collected, filters are delivered to the communities.

In Nicaragua, 15% of filters that were monitored over a six month span incurred breakages (Hwang 2003). Studies on similar filters in Cambodia have identified a 2% ceramic filter disuse rate per month, mostly due breakages (Brown 2007). According to PHW, it is recommended that *Kosim* filters be replaced every three to five years (Jackson and Murcott 2007).

Peletz's and Johnson's research determined the effectiveness of the *Kosim* filter at mitigating diarrhea in Northern Region, Ghana. Peletz determined that the use of the *Kosim* filter reduced the risk of diarrhea by 42% for children under five (Peletz 2006). Johnson found that households with filters were 69% less likely to have diarrhea when compared to households without filters (Johnson 2007). In Cambodia, the ceramic filters reduced diarrheal rates among users by 40% when compared with non-users (Brown and Sobsey 2006)

1.3.1.1 History

In 1981, the InterAmerican Bank funded a research study to determine the most efficient and sustainable filter (Central American Research Institute of Industrial Technology (ICAITI) 1984). The filters were judged by their flow rate, their effectiveness at removing bacteria, their cost, their ease of distribution, and whether they could be locally made. One of the groups receiving funding for this study was the Central American Research Institute for Industry (ICAITI). Dr. Fernando Mazariegos worked for the ICAITI and was the first to develop a colloidal silver impregnated ceramic pot filter. Mazariegos' filter was handmade and was effective at treating microbially contaminated waters (ICAITI, 1984). His filter was also cost-effective and easily produced. In 1984, Mazariegos received funding from the United States Agency for International Development (USAID) to work with Medical Assistance Programs (MAP) International to spread the colloidal silver ceramic filter design to Quechua potters in Cotopaxi, Ecuador (Medical Assistance Programs (MAP) International 1985).

In 1994, after Guatemalan communities rejected the use of chlorine tablets, AFA Guatemala investigated using Mazariegos' filter technology as an alternative. They conducted a one-year study that indicated that using the ceramic pot filter reduced the incidence of diarrhea by 50% (Donachy 2004). Later, in 1998, Hurricane Mitch devastated drinking water sources across Central America, which affected an estimated 18% of the population in Nicaragua (United States Aid for International Development (USAID) 2001). This disaster created a need for a simple, low-cost, mass-produced, water treatment technology. In response, Potters for Peace (PFP) standardized the shape and size of Mazariegos' filter and began mass-producing them for implementation in 1998 (Rivera 2008).

Since then, the PFP filter—originally designed by Mazariegos—has reached 1.5 million users in 21 countries across the world in Central America, the Caribbean, West Africa and South East Asia (Rivera 2008). To accomplish this, approximately 30 locally owned

and operated filter manufactures have been established in these areas of the world. The PFP filter is commonly known as the *Filtron* in Central America and by various other brand names in specific countries. In Ghana, it is known as the *Kosim* filter.

1.3.1.2 Use

To use the *Kosim* filter, all one must do is fill the ceramic pot-shaped filter with water and allow gravity to perform the filtration. One must ensure that the lid to the ceramic filter is always on so that the water is not contaminated by airborne particles or unhygienic handling. While the actual use of the filter is simple, there are specific instructions for cleaning. The filter itself must be scrubbed frequently with filtered water to remove filtered particles and microbes. In Northern Ghana, it is recommended that filters be cleaned after each use. Also, the inside of the storage receptacle should be cleaned with chlorine once a month.

1.3.1.3 Aquatabs



Figure 6: Strip of 10 Aquatabs

Aquatabs are chlorine tablets that meet internationally recognized specifications for water treatment. The primary chemical constituent of Aquatabs is sodium dichloroisocyanurate (NaDCC or $C_3HCl_2N_3O_3Na$), also known as sodium troclosene, triclosene sodium, or sodium dichloro-sy-triazine (Medentech, 2006). The two other primary constituents are adipic acid and sodium carbonate, which are added to maintain a constant pH in the water of 6.2 (Bakhr, 2003). This pH value ensures optimal conditions for the NaDCC to release a measured dose of hypochlorous acid (HOCL, which is referred to as the free available chlorine (FAC) level in this thesis) (Zen Backpacking, 2005). HOCL is electrically neutral, which allows for ease of diffusion through cell walls. After passing through the cell wall, the HOCL reacts with the proteins, DNA, RNA, fatty acid groups, cholesterol, or enzyme systems of the cell, which inactivates the bacteria.

Table 4: Chemical Composition of Aquatabs by Weight (Medentech Ltd. 2001)

Ingredient	Weight in Product (% w/w)
Trosclosene Sodium / 1,3,5 - Triazine - 2,4,6 (1H, 3H, 5H) - trione, 1, 3 - dichloro-, sodium salt CAS No. 2893 - 78 - 9	39.41%
Adipic Acid CAS No. 000124-04-9	26.71%
Sodium Carbonate CAS No. 000497-19-8	6.00%

The tablets come in a variety of sizes and readily dissolve in water without leaving any deposits. They are used as a point-of-use water treatment, meaning they are applied directly to the water source, for emergency relief and routine household water disinfection (Da Vinci, 2006). In the past, Aquatabs have been supplied to the following International Aid Agencies: WHO/PAHO, UNICEF, Red Cross Organizations, Medicines Sans Frontiers, CARE, ECHO, and World Vision (Medentech, 2006). In terms of routine household water disinfection, Aquatabs are currently being used in Haiti, Venezuela, Tanzania, Kenya, and other countries (Medentech, 2006). Another use of Aquatabs is for the disinfection of water tanks, water transporters, wells, boreholes and water pipelines. According to the manufacturer, Aquatabs are preferred over hypochlorite in terms of taste and odor (Medentech, 2006).

The primary function of Aquatabs is to kill pathogenic microorganisms in drinking water, which can cause waterborne diseases like cholera, typhoid, dysentery, diarrhea, etc. They are effective at treating natural waters with various pHs and fecal contamination values (Medentech, 2007).

Aquatabs are non-hazardous for transportation. Additionally, due to the relatively small size of the tablets, they are easily shipped and handled. Aquatabs have a shelf-life of 5 years in strip-packs (typically strips of 10 tablets) and 3 years in unopened tubs.

Aquatabs are also distributed in granular form.

1.3.1.4 Medentech Background

Aquatabs are manufactured by Medentech Ltd. Medentech is an Irish company that was established in 1984 (Da Vinci, 2006). They are a pharmaceutical manufacture with a certificate of Good Manufacturing Practice (GMP) (Medentech, 2007). The WHO has its own guidelines for GMP pharmaceutical products, which require documentation for each step of product manufacturing (WHO, 2008). This ensures that every unit produced is the same and is of good quality. Most countries will only accept GMP certified products.

Medentech specializes in effervescent (a process by which gas escapes from liquid causing the liquid to “fizz”) tablets and granules for healthcare. They have been distributing Aquatabs for relief situations since the mid-1980’s. Currently, Medentech manufactures and distributes products to Western and Eastern Europe, Australia, Asia, North America and Latin America.

1.3.1.5 Aquatabs Tablet Weight and Dosing Requirements

Aquatabs tablets are available in a variety of sizes to treat specified volumes of water. Furthermore, the volume of treatable water per tablet depends upon the contamination of the water source. For every day use and clear water sources, the dosage should be 2 mg/L of FAC (Medentech Ltd. 2006). For emergency situations and dirty/fecally contaminated water sources the dosage should be 4-6 mg/L of FAC. The reason for this increased dosing is that the hypochlorous acid will react with the organic and inorganic materials found in dirty waters. As a result, more needs to be added so that the chlorine can adequately treat the water.

Table 5: Aquatabs and Dosages (Medentech Ltd. 2007b)

Every Day Use		Emergency Use	
NaDCC Content Per Tablet (mg)	Water Treated Per Tablet (L)	NaDCC Content Per Tablet (mg)	Water Treated Per Tablet (L)
Strip-Packed Product			
3.5	1	8.5	1
17	5	17	2
		33	4-5
67	20	67	8-10
		167	20-25
500	150		
Tablets Packed in Tubs			
1670	500	1670	200
8680	2500	8680	1000-1250

The reason that certain tablets are used only for every day use and others only for emergency use is that some tablets are more relevant for given situations. Typically, the amount of treatable water for dirty/fecally contaminated water sources is half that of clear water sources, when using tablets of the same weight and content. Additionally, the reason that ranges of treatable water are provided in Table 5 is because the amount of treatable water depends on the degree of contamination among dirty water sources. Using 67 mg tablets, only 8 L of heavily contaminated water could be treated, where as 10 L of less contaminated water could be treated with the same tablet.

Therefore, the first step in water treatment with Aquatabs is to select a size/dosage that will adequately treat the water sample. The tablet is then placed in the water sample, it self-dissolves, and in 30 minutes the water is safe to drink. There is no need to stir the water unless the volume exceeds 200 L, in which case the water must be stirred for even

distribution. Additionally, waters which exceed turbidity values of 80 NTU should be filtered before treatment (Da Vinci and Medentech Ltd. 2006).

In keeping with the WHO's Guidelines for Drinking Water Quality (2004), Medentech recommends that the free available chlorine (FAC) levels be greater than 0.5 mg/L 30 minutes after the tablets have been added. Additionally, 24 hours after the tablets have been added, the recommended FAC level should be no less than 0.2 mg/L to ensure that all of the bacteria are killed (Center for Disease Control (CDC) 2008). Medentech also recommends that the FAC level never exceed 5mg/L in the water sample (Medentech Ltd. 2006). In contrast, the CDC recommends that 30 minutes after chlorinating there should be no more than a 2.0 mg/L FAC residual (Center for Disease Control (CDC) 2008). These two upper limits of 2 and 5 mg/L FAC residual are used to ensure that there isn't an unpleasant taste or odor in the water.

1.3.1.6 Aquatabs Use in Ghana

Currently there are no Aquatabs in use in Ghana. In preparation for implementing this technology, Medentech funded a Center for Disease Control (CDC) pilot study in 2006 on the use of Aquatabs in Bipelar, a middle-class community in Northern Region, Ghana (Blanton, 2006). It is important to note that Bipelar is a community with access to piped water supply. However, many rural communities in Northern Region, Ghana rely solely upon dam water as their drinking water source. The high turbidity in these dam waters makes chlorination by itself—without other treatment—unstable, which is likely why a community with a piped water supply was selected.

Blanton, the principal investigator for the CDC, surveyed 240 households which included 3,240 household members in Biplar. She taught these households how to use the Aquatabs, provided a three month supply, and then returned 22 times to follow-up and to do water testing. At the end of her survey, 98% of the households were still using the water treatment tablets. Additionally, 75% of the water samples taken consistently showed a FAC residual greater than 0.1mg/L. In terms of EC, Blanton compared households that she provided with Aquatabs with a control group using a placebo. Among the households with Aquatabs, the percentage of samples with no indication of EC present increased from 4.2%-83%-92% from her baseline visit to her midterm visit to her final visit, respectively. Likewise, among the control households the samples with no indication of EC present varied from 12.5%-9.1%-50% from her baseline visit to her midterm visit to her final visit, respectively.

After a tragic flood devastated Northern Ghana in September, 2007 leaving thousands homeless and without water, Medentech shipped 10 million Aquatabs to support the flood victims. After long delays, these tablets were cleared through customs in December, 2007 and are now ready for distribution.

1.3.2 Community-Scale Chlorination Technology

For a community with a larger water supply, other types of technologies become more appropriate. In selecting a system many criteria need to be considered such as access to electrical power, availability of chlorine types (gas, liquid, or dry), the type of inlet water (constant or variable), and even the stability of the various influent parameters. Below is a discussion of various community-scale chlorination approaches used in Ghana and other developing countries. For further detail, refer to the publication titled “Chlorinating Small Water Supplies” by Skinner, published in 2001.

1.3.2.1 Tap Water in Tamale, Ghana

The source of tap water within the Tamale city area is the White Volta River, which is treated at the Dalun Water Treatment Plant. Located approximately 35km northwest of Tamale, the plant is driven by two pumps which move about 2.8 MGD each at full capacity. The treatment train consists of coagulation, flocculation, settling and sludge disposal, filtration, and chlorination disinfection processes (Okioga 2007).

After treatment, the water is distributed via a piped network. It's estimated that supply coverage is about 65% within Tamale, which corresponds to approximately 198,000 people with approximately 7,000 domestic and commercial connections. In addition, the system is undergoing an expansion which is planned to bring the treatment plant capacity to 11.6 MGD, which should cover 500,000 people (Okioga 2007). The current system provides only intermittent coverage. For instance, piped water was supplied one day per week at the Peace Corps sub-office in a middle class neighborhood within Tamale.

The disinfection system at the Dalun Water Treatment plant is through a feeder which supplies chlorine gas via a chlorinator. The backup system is comprised of chlorinated lime, but careful planning must be exercised to ensure that other constituents added do not interfere with the process. For instance, the Dalun plant adds lime only after chlorination to raise the pH for corrosion control through its piped distribution network. If lime was added prior to chlorination the disinfection process could be significantly hindered.

1.3.2.2 Gravity Driven Chlorinators

These devices are characterized by the chlorine solution being dosed only by gravity forces. The main advantage of doing so is the simplicity and non-reliance on electricity, which results in lower maintenance problems and associated costs. Although the specific designs and materials vary considerably, many common types operate by keeping the pressure constant on a control valve (Skinner 2001). This ensures the dosing amount will also remain constant as well. The system is then calibrated to output the desired amount, which must be verified routinely.

One example of such a gravity driven community scale chlorination system is being pilot tested by the Kenya Rural Water Project (RWP), which is a collaborative research project between an NGO in Kenya called Innovations for Poverty Action (IPA) and researchers at Harvard and UC Berkeley. While the most common chlorination method in rural Kenya is household chlorination via a product called WaterGuard, the RWP has located the chlorine dispensers directly at the site of collection. The water is thus dosed and *then* taken back to the household (Berens and Van Dusen 2007). Figure 7 shows a picture of the unit installed on site in Kenya.



Figure 7: The RWP Installed Chlorine Dispenser in Kenya (Berens and Van Dusen 2007)

The project uses a chlorine dispenser which has been pre-calibrated to dose a certain concentration and volume via gravity. The component parts include off-the-shelf PVC pipe, an adapted ball valve to provide the correct dose, and a lockable metal box & stand. Figure 8 illustrates how the ball valve dispenses a pre-set chlorine dose by gravity directly into a jerry can, which is typically used for water collection. The ball valve has been partially hollowed out to release a specific amount (3 mL) of 1% sodium hypochlorite solution (WaterGuard) each time the valve is rotated one full turn.



Figure 8: Close-Up of Chlorine Dispenser and Jerry Can (Berens and Van Dusen 2007)

1.3.2.3 Diffusion Chlorinators

Diffusion chlorinators operate by allowing the influent water to directly contact a solid chlorine compound. Often they are immersed in a water source such as a well or storage tank, or they can be systems where water flows by and dissolves tablets.

Pot Chlorinator

One example of the immersion-type chlorinator used to disinfect shallow dug wells is an open-mouthed pot chlorinator. The inside is packed with a mix of bleaching powder and layers of clean sand and pebbles to encourage slower chlorine diffusion. The unit is then lowered down and submerged into the contaminated well. By requiring only basic tools and materials for construction, this is arguably one of the simplest available alternatives. This simplicity, however, comes at the direct cost of minimal dosing control.

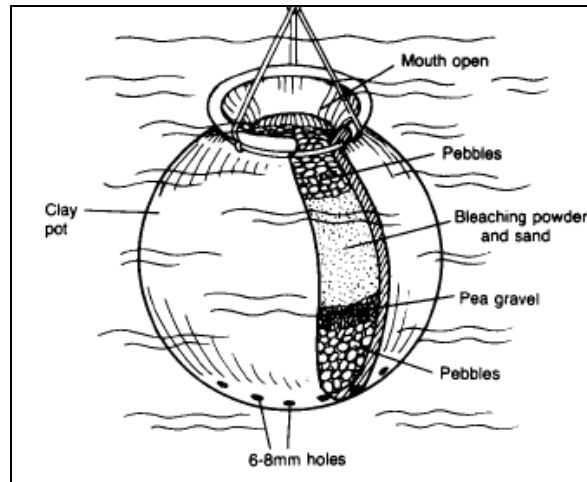

Figure 9: Design of a Pot Chlorinator (Water for the World 2007)

The other type of diffusion chlorinator involves running water directly contacting the dry solids. Also referred to as an erosion technology, it is most appropriate for small communities without reliable energy and low maintenance requirements. Some potential advantages of this system include automatic dosing proportional to flow and simplistic setup & operation.

CTI-8 Chlorinator

One such example is called the CTI-8 Chlorinator, which forces diverted water over $2\frac{5}{8}$ " diameter chlorine tablets which dissolves into the flow stream. This system was designed by Charles Taflin, a retired superintendent of Minneapolis Waterworks. The unit is capable of treating 2-10 gpm, is made from local PVC materials, and costs less than \$20. The system is installed in over 30 rural communities in Nicaragua as a result of a partnership between the Nicaraguan Water Ministry and two NGOs, Compatible Technology Inc. and Laboratories for Rural Health (TASCA). (Yamana and Nepf 2003). Research conducted at MIT in 2003 concluded the system's dissolution rate from the tablets did not increase as flow rate became larger. The author surmised the CTI-8 thus might be vulnerable to daily and seasonable flow rate variations because of periodic under-dosing (Yamana and Nepf 2003). Figure 10 below shows a CTI-8 unit installed in Nicaragua.



Figure 10: CTI-8 Chlorinator Installed in Nicaragua (Yamana and Nepf 2003)

Sanikit Chlorinator

Another such example is Arch Chemical's Sanikit. As water flows through a pipe, the Sanikit diverts part of the flow (approximately $\frac{1}{4}$) into a chamber where it dissolves solid chlorine tablets. If flow into the chamber increases, the water level will be raised, which then contacts and dissolves more chlorine. Likewise, a decreased flow into the chamber will result in less tablet contact. As the concentrated solution leaves the contact chamber, it is then recombined with the other $\frac{3}{4}$ flow. It then goes into a storage container to allow for a contact time of at least 30 minutes (International Committee of the Red Cross 2002).



Figure 11: The Sanikit System (Trevalinet 2006)

As of 2006, more than 400 Sanikit units have been installed throughout Africa. Within Ghana alone, the Community Water and Sanitation Agency (CWSA) has financed almost 70 units since 1999 (Trevalinet 2006). Unfortunately, this unit also suffers from limited

dosage control (Blanchette 2006). This has both technical performance and consumer acceptability ramifications. From a technical perspective, correct dosage in the range of 0.5 mg/L to 2.0 mg/L is the CDC recommended guideline value (Center for Disease Control (CDC) 2004). From a consumer acceptability perspective this is especially problematic where consumer taste preferences are very strong, e.g. when consumers do not like the taste of chlorine.

1.3.2.4 Water-Powered Chlorinators

The final type of chlorinator also requires moving water, but now instead of contacting dry chlorine solids directly, a chlorine solution is first created and then mixed with the contaminated influent water. This mixing is achieved by either a powered mechanical device or a pressure differential created by the system. Since many rural communities in developing countries do not yet have access to electricity, the latter option is likely to be more appropriate.

A common way to induce the required pressure differential is by using a venturi. By purposely constricting a pipe, both the water velocity and pressure is altered at that point. By placing a venturi at the end of a system, a pressure differential is created that effectively creates a suction force which can pull water through the treatment system.

One such unit that operates in this fashion is Arch Chemical's Pulsar 1. Although originally designed for swimming pools, it could potentially also be used to meet drinking water chlorination criteria. Such a possibility is the focal point of this thesis.

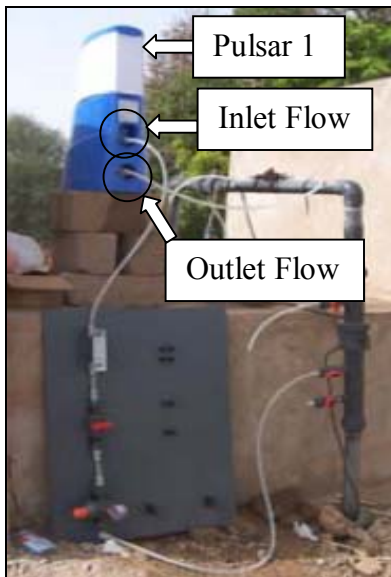

Figure 12: Arch Chemical's Pulsar 1 Technology (Trevalinet 2006)

Also referred to as a wave technology, the output concentrations are based directly on the inlet flow rate. Since each inlet flow rate value will induce a specific output suction flow, increasing the former will have the same effect on the latter.

1.3.3 High-Test Hypochlorite (HTH)

The chlorine product used in the Pulsar 1 is high-test hypochlorite (HTH), which is a form of dry calcium hypochlorite. It is made by a company named Arch Chemicals, which is headquartered in Norwalk, CT. Arch is the world's largest producer of calcium hypochlorite water sanitizers and makes units which are used in a wide range of applications including food production, swimming pools, and municipal drinking water systems (Arch Chemicals 2003b).

HTH is currently in use in several African countries including Cameroon, Mali, Benin, Nigeria, Senegal, Ghana, and others. Arch's various chlorine dosers include the Sanikit and Pulsar 1 (appropriate for small and rural community water supply), and the Constant Chlor (for larger sized municipal water systems in urban areas) (Trevalinet 2006).

With free available chlorine content of 68%, it remains the most highly concentrated dry chlorine product on the market (Arch Chemicals 2000) (Meyer 2004). As a comparison, liquid household bleach has roughly only 5.25% available chlorine (CDC 2004). HTH is packaged in either granular or tablet form, and has a shelf life of 1-2 years depending on storage conditions (Tew 2006). Figure 13 shows a container and contents of the 7 gram HTH tablets used for the Pulsar 1 system.



Figure 13: High-Test Hypochlorite (HTH) Container and Briquettes for Pulsar 1 System

There are potential negative weather effects on the HTH, including rapid decomposition or combustion. The Material Safety Data Sheet (MSDS) for HTH calcium hypochlorite lists the maximum recommended storage temperature to be 125 degrees Fahrenheit (~52 degrees Celsius) (Arch Chemicals 2001). Parts of Ghana can experience weather of this

magnitude, and as such both the Pulsar unit and the HTH briquettes should be kept out of the sun at all times. No such problems were experienced in the course of this research because the temperature never rose above ~105 degrees Fahrenheit in the month of January 2008. Moreover, the product should not come into contact with certain other materials. Section 10.5 in the appendices includes the Material Safety Data Sheet (MSDS) of the HTH briquettes used by the Pulsar 1 unit.

1.3.4 Selection of Arch Chemical's Pulsar 1

After researching the various options available during Fall 2007 and taking into consideration the Northern Ghanaian context, it was concluded that the Pulsar 1 unit would be most-appropriate to conduct research in Northern Region Ghana.

The Pulsar was thought to offer an advantage over its Sanikit counterpart because it could theoretically provide more accurate dosing. Having a narrow and dependable free chlorine residual concentration range is important because if the system under-doses then the water is no longer safe to drink, and over-dosing may lead to locals no longer finding the taste acceptable. This can lead to them looking for an alternative source of drinking water or using the treated water to wash clothes.

1.3.4.1 History of Pulsar 1 Research in Mali

Previous research and pilot testing of the Pulsar 1 unit was conducted in Mali, West Africa during March 2005. The work was done by an NGO named Eau Lambda in conjunction with Arch Chemicals, and at the time was the first pilot test of a wave technology system in a remote area of Africa (Trevalinet 2006).

The site was a rural village named Dioncoulane with 6,500 inhabitants whose drinking water supply consisted of boreholes (Eau Lambda 2005). The findings were largely positive and included:

- Successful demonstration of Pulsar 1 unit to function within drinking water standards;
- Stable and consistent output levels;
- Ability to run the water to and from the Pulsar 1 unit by gravity forces only (although pumping was used to obtain water from the boreholes);
- Only a marginally small cost impact for treatment;
- Minimal maintenance.

In order to estimate the costs of chlorine, some assumptions were made. The Mali report assumed a treatment dose of 3 g/m³ (3 mg/L or 3 ppm). By using the local cost of HTH in Mali, the researchers were able to calculate the treatment cost.

Table 6 helps determine how much HTH (called CCH for calcium hypochlorite in this table) will be required for a certain amount of treated water. Since all the numbers are

linear (it requires 10 times as much HTH for 10 mg/L than for 1 mg/L), the values can be interpolated.

Table 6: Amount of HTH Used Based on Treatment Level (Arch Chemicals Accessed 2008)

Treatment Parts Per Million Available Chlorine	Weight of <i>CCH</i> Dry Chlorinator Required to Treat Volume of Water In Liters					
	<u>100</u>	<u>200</u>	<u>300</u>	<u>400</u>	<u>500</u>	<u>1000</u>
	Grams of <i>CCH</i> Dry Chlorinator Required					
0.5	0.08	0.15	0.23	0.31	0.38	0.77
1	0.15	0.31	0.46	0.62	0.77	1.54
5	0.77	1.54	2.31	3.08	3.85	7.69
10	1.54	3.08	4.62	6.15	7.69	15.4
15	2.31	4.62	6.92	9.23	11.5	23.1
20	3.08	6.15	9.23	12.3	15.4	30.8
25	3.85	7.69	11.5	15.4	19.2	38.5
30	4.62	9.23	13.8	18.5	23.1	46.2
40	6.15	12.3	18.5	24.6	30.8	61.5
50	7.69	15.4	23.1	30.8	38.5	76.9
60	9.23	18.5	27.7	36.9	46.2	92.3
70	10.8	21.5	32.3	43.1	53.8	108
80	12.3	24.6	36.9	49.2	61.5	123
90	13.8	27.7	41.5	55.4	69.2	138
100	15.4	30.8	46.2	61.5	76.9	154
200	30.8	61.5	92.3	123	154	308
300	46.2	92.3	138	185	231	462
400	61.5	123	185	246	308	615
500	76.9	154	231	308	385	769
600	92.3	185	277	369	462	923
700	108	215	323	431	538	1077
800	123	246	369	492	615	1231
900	138	277	415	554	692	1385
1000	154	308	462	615	769	1539

By using Table 6, it can be computed that 0.45 grams of HTH is required to treat 100 liters of water at 3 mg/L dosage. The same assumed dosage value from the Mali experiment (3 mg/L) was used for this calculation as well because it seemed reasonable. Since the local cost of HTH in Ghana is \$280 for a 40 kg drum, the cost of HTH treatment (in \$/m³) may be estimated by the following simple calculation (Tew 2008).

$$\left(\frac{0.45g_HTH}{100L_of_water}\right) \times \left(\frac{\$280}{40kg_HTH}\right) \times \left(\frac{1kg_HTH}{1000g_HTH}\right) \times \left(\frac{1000L}{1m^3}\right) \equiv \$0.032 / m^3$$

The results of the Mali study show the potential for the Pulsar 1 unit to be used for cost effective disinfection of a small community’s water supply in a rural area. However, further testing would need to be done in other locations to further prove its efficacy. This paper is aimed at continuing and expanding the knowledge base of this possible technology and application.

1.3.4.2 Design and Operation of the Pulsar 1

The Pulsar 1 runs as a parallel system, which means for a given water pipeline the unit will “tap into” or divert away a portion of the flow for itself for treatment. The quantity of diverted flow is proportionally based on the flow through the water line, so as the main water line flow increases, so does the diverted flow to the Pulsar.

Once the diverted water enters the Pulsar, it is directed to a chamber where it contacts solid chlorine tablets (called high-test hypochlorite or HTH). A concentrated aqueous chlorine solution is then formed which drips down to the base of the unit where it is pulled out of the Pulsar and re-injected back into the main line. Figure 14 below shows this internal progression throughout the Pulsar system.

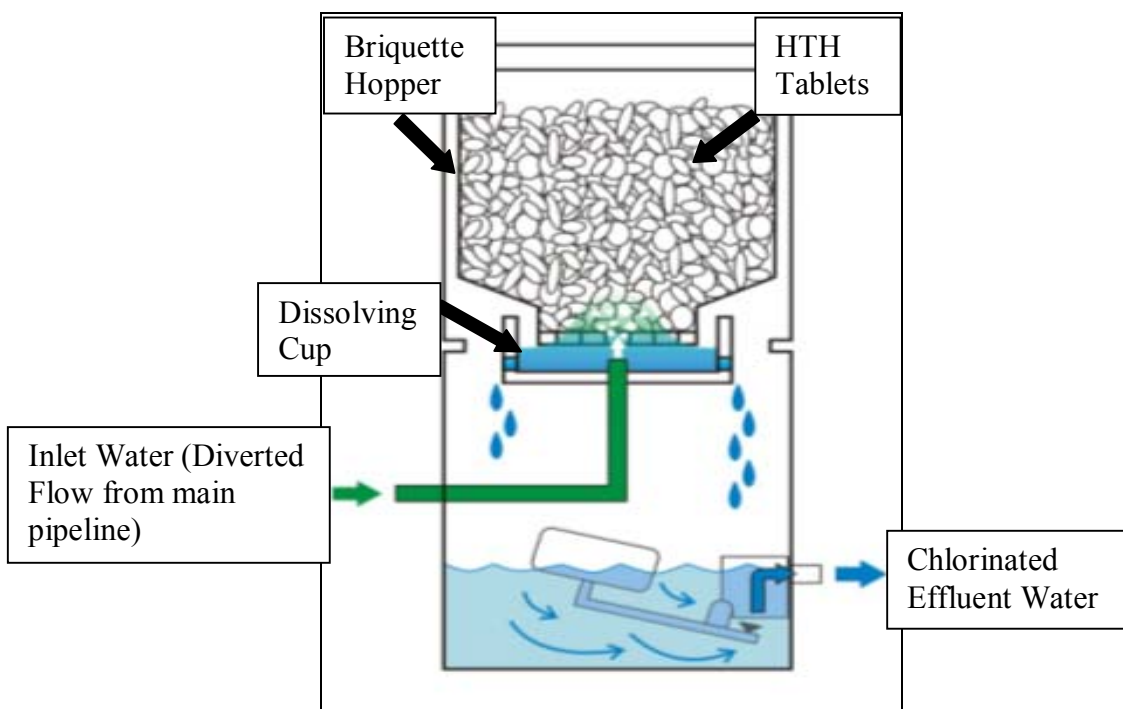

Figure 14: Pulsar 1 Internal Flow Diagram (Blanchette 2006)

The Pulsar 1 system is classified as a “wave” technology because the influent water is directed into the *dissolving cup*, where the water level rises similar to a wave and contacts the solid HTH tablets located inside the *briquette hopper*. The *ball valve* and *emergency shutoff valve* control the flow rate into the Pulsar at a given water pressure by either regulating the inlet flow or closing the valve if the solution height in the base becomes too high, respectively. Once the concentrated chlorine solution is created, a vacuum force created by a *venturi* pulls the chlorine solution out of the Pulsar unit and back into the main line. As the inlet flow decreases, so does the water level in the dissolving cup and the outlet flow. Figure 14 & Figure 15 shows diagrams of where these parts are located, how they interact, and the inlet & outlet water flow direction (as dictated by the blue arrows).

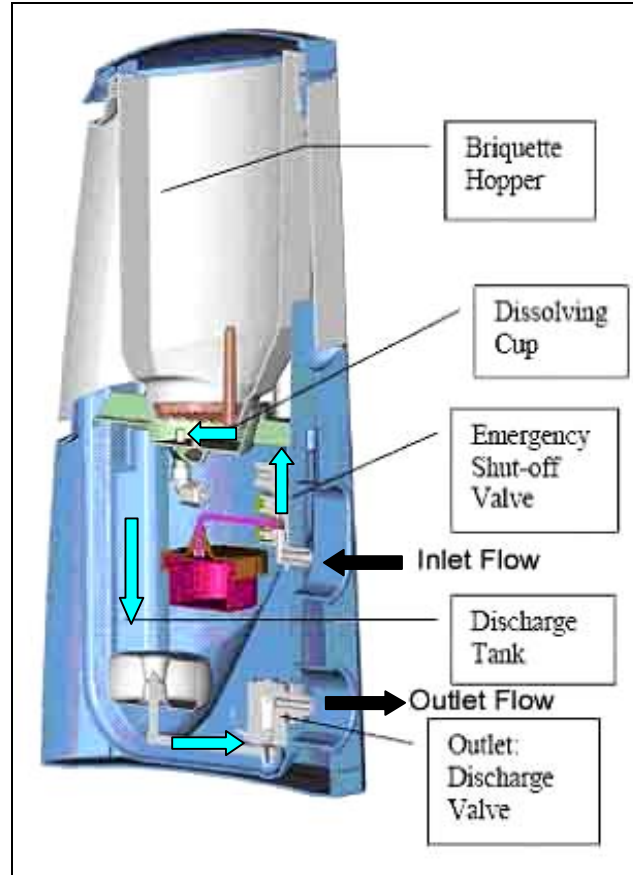

Figure 15: Pulsar 1 Internal Parts Diagram (Arch Chemicals 2003a)

The physical requirements of the Pulsar system are provided by the manufacturer (Arch Chemicals 2003a). Key requirements include:

- The inlet pressure range is 2-20 pounds per square inch (psi), with an ideal value of 12 psi. For the Ghana system, this was entirely created by an elevation difference and gravity flow;
- The vacuum created by the venturi requires a pressure range of 2-29" of mercury;
- The operating temperature of the system is 40-130 degrees Fahrenheit. In Ghana, the higher range is of more concern because the HTH can degrade rapidly at higher temperatures;
- The inlet flow range is 0.2-1.05 gallons per minute (gpm);
- The minimum outlet flow is 1.1 gpm;
- The briquette hopper capacity is 28 pounds of HTH tablets;

It should be noted that the author's research ended up testing the unit's capabilities for several of these parameters on the lower end because the water system in Ghana was relatively small.

Overall, the main advantages of the Pulsar system are its ability to operate without electricity (the entire system is gravity-fed), the unit's capability to treat high volumes (>100,000 L/day or >26,400 gal/day) of water while maintaining accurate dosing, and its relatively low treatment cost.

1.4 Research Objectives

One of the aims of MIT's water research in developing countries is to contribute to the knowledge on how to provide microbiologically safe drinking water via an effective chlorine disinfection process (MIT 2007). Prior research in Ghana looked into the possibility of solar disinfection using innovative variations on SODIS (solar disinfection in PET plastic bottles), which proved not to be effective in this particular location because of local challenges with high turbidity and Harmattan dust storms (Yazdani 2007).

Chlorination is a logical disinfection approach for Northern Ghana because it can follow other existing processes such as filtration via the *Kosim* filter, a biosand filter, or coagulation (with alum for example). The two potential chlorine products currently available in Ghana are Aquatabs and HTH dry calcium hypochlorite (Murcott 2007b). Master's of Engineering research by A. Swanton (2008) is currently looking into the possibility of Aquatabs coupled with the *Kosim* filter, and this thesis project will be looking into the applicability of HTH.

1.4.1 General Objective

The overall goal of this thesis is to investigate the technical feasibility of available chlorine disinfection options for drinking water on both the household and community scales in the Northern Region of Ghana.

1.4.2 Specific Objectives

The specific objectives are to:

- Determine the local water quality parameters for chlorine disinfection including turbidity, pH, chlorine demand, and free & total chlorine residuals;
- Assess the technical feasibility of applying a Pulsar 1 unit in order to obtain proper free chlorine residual output ranges for drinking water. Appropriate ranges are defined by the CDC as no greater than 2.0 mg/L after 30 minutes and at least 0.2 mg/L after 24 hours of storage (CDC 2005b). The Pulsar unit is designed to chlorinate swimming pools which already have high chlorine demands. One of the specific objectives of the pilot study is to determine whether it is possible to offset these factors for drinking water purposes if the influent water source is large enough;
- Predict the likely future factors of success and failure if such Pulsar units are installed elsewhere;
- Compare the community scale (HTH) and household level (Aquatabs) chlorination options based on performance, cost, and appropriate application.

2.0 Water Disinfection Using Chlorine

Water disinfection destroys harmful microorganism pathogens including bacteria, viruses, and protozoa. While certain pathogens can be eliminated through sedimentation and natural die-off by storage in open tanks, this is often unacceptable because of the resulting growth of algae and other sources of contamination. Figure 16 below shows a partial list of such pathogens, their health significance, persistence in water supplies, resistance to chlorine, their relative infectivity, and their link to animal sources.

Pathogen	Health significance	Persistence in water supplies ^a	Resistance to chlorine ^b	Relative infectivity ^c	Important animal source
Bacteria					
<i>Burkholderia pseudomallei</i>	Low	May multiply	Low	Low	No
<i>Campylobacter jejuni, C. coli</i>	High	Moderate	Low	Moderate	Yes
<i>Escherichia coli</i> – Pathogenic ^d	High	Moderate	Low	Low	Yes
<i>E. coli</i> – Enterohaemorrhagic	High	Moderate	Low	High	Yes
<i>Legionella</i> spp.	High	Multiply	Low	Moderate	No
Non-tuberculous mycobacteria	Low	Multiply	High	Low	No
<i>Pseudomonas aeruginosa</i> ^e	Moderate	May multiply	Moderate	Low	No
<i>Salmonella typhi</i>	High	Moderate	Low	Low	No
Other salmonellae	High	May multiply	Low	Low	Yes
<i>Shigella</i> spp.	High	Short	Low	Moderate	No
<i>Vibrio cholerae</i>	High	Short	Low	Low	No
<i>Yersinia enterocolitica</i>	High	Long	Low	Low	Yes
Viruses					
Adenoviruses	High	Long	Moderate	High	No
Enteroviruses	High	Long	Moderate	High	No
Hepatitis A virus	High	Long	Moderate	High	No
Hepatitis E virus	High	Long	Moderate	High	Potentially
Noroviruses and sapoviruses	High	Long	Moderate	High	Potentially
Rotaviruses	High	Long	Moderate	High	No
Protozoa					
<i>Acanthamoeba</i> spp.	High	Long	High	High	No
<i>Cryptosporidium parvum</i>	High	Long	High	High	Yes
<i>Cyclospora cayetanensis</i>	High	Long	High	High	No
<i>Entamoeba histolytica</i>	High	Moderate	High	High	No
<i>Giardia intestinalis</i>	High	Moderate	High	High	Yes
<i>Naegleria fowleri</i>	High	May multiply ^f	High	High	No
<i>Toxoplasma gondii</i>	High	Long	High	High	Yes
Helminths					
<i>Dracunculus medinensis</i>	High	Moderate	Moderate	High	No
<i>Schistosoma</i> spp.	High	Short	Moderate	High	Yes

Note: Waterborne transmission of the pathogens listed has been confirmed by epidemiological studies and case histories. Part of the demonstration of pathogenicity involves reproducing the disease in suitable hosts. Experimental studies in which volunteers are exposed to known numbers of pathogens provide relative information. As most studies are done with healthy adult volunteers, such data are applicable to only a part of the exposed population, and extrapolation to more sensitive groups is an issue that remains to be studied in more detail.

^a Detection period for infective stage in water at 20°C: short, up to 1 week; moderate, 1 week to 1 month; long, over 1 month.

^b When the infective stage is freely suspended in water treated at conventional doses and contact times. Resistance moderate, agent may not be completely destroyed.

^c From experiments with human volunteers or from epidemiological evidence.

^d Includes enteropathogenic, enterotoxigenic and enteroinvasive.

^e Main route of infection is by skin contact, but can infect immunosuppressed or cancer patients orally.

^f In warm water.

Figure 16: Waterborne Pathogens and Their Significance in Water Supplies (WHO 2006)

Strategies for disinfection vary depending on the source – groundwater, surface water, or rainwater. Groundwater usually contains low levels of organics, consistent quality, and higher amounts of inorganic compounds. Rainwater is usually relatively clean, with the

main contaminants coming from the atmosphere and to a lesser extent the roof or other collection surface (WHO 2007). However, quality may still be deteriorated during harvesting and storage. Surface waters often have high levels of suspended materials and organics, variable quality, and higher levels of pathogens (M20 Manual of Water Supply Practices 2006). This is also the most common source in the Northern Region (Ghana Statistical Service (GSS) et al. 2004).

Surface water treatment is also the most complicated of the three. The elevated levels of organics require greater chlorine concentrations and longer contact times, and care must be taken to ensure harmful chlorination byproducts are either not formed or properly removed afterwards. Chlorine resistant organisms such as *Giardia* and *Cryptosporidium* further complicate treatment and ideally necessitate a combination strategy of coagulation, filtration, and disinfection.

In order to measure disinfection efficacy, the concept of “Ct” is used. “C” is the free chlorine residual (in mg/L) and “t” is time (in minutes); the two terms are multiplied together to obtain a value. For instance, if water contains a 2 mg/L solution of free chlorine for 30 minutes, then the Ct value is 60 mg/L-min. Figure 17 shows an example of a Ct chart of disinfection of various microorganisms with a two-log disinfection efficiency (99% removal).

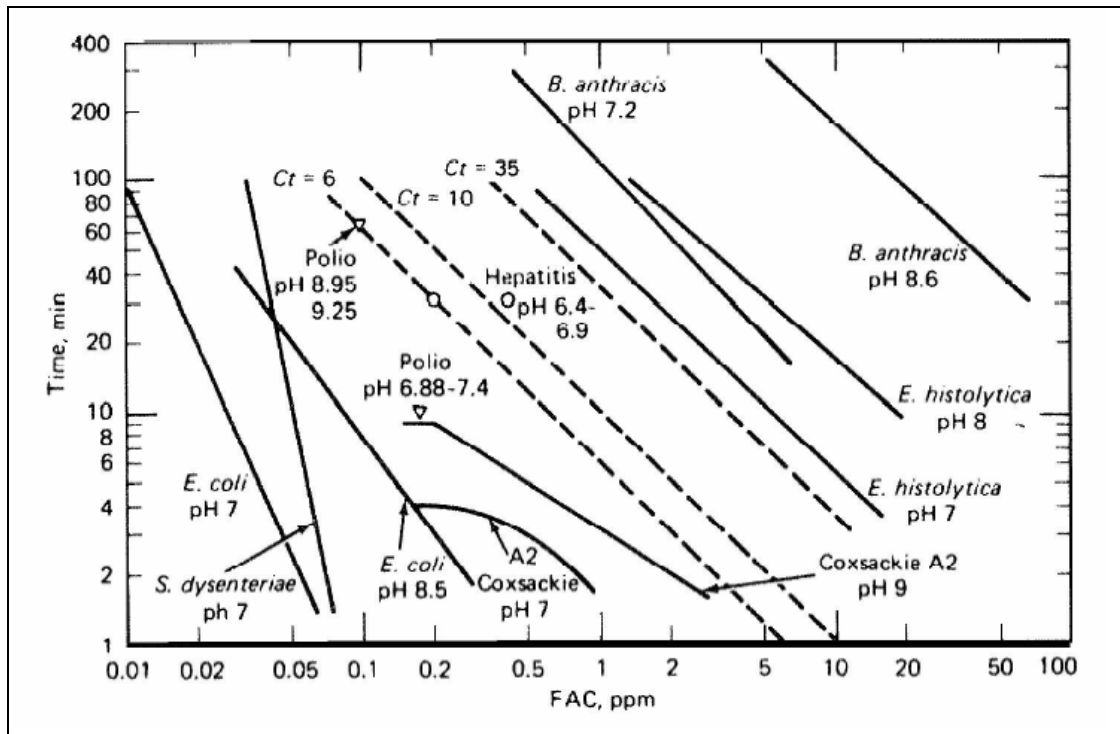

Figure 17: Disinfection (2 Log) of Selected Microorganisms Using Free Available Chlorine (FAC) (WHO 2004)

2.1 Chlorine Chemistry

When chlorine is added in water, the two main disinfectant species formed are hypochlorous acid (HOCl) and hypochlorite ion (OCl⁻). Together, they are called “free available” chlorine. Of the two, hypochlorous acid is the more effective disinfectant but can be dissociated at high pH values. The following two equations show the relationships between solutions of calcium hypochlorite.



Any ammonia present in natural waters will react with the hypochlorous acid and hypochlorite ions to form chloramines. The chlorine demand of such reactions with ammonia is called the “combined chlorine.” These reactions are important because chloramines are a comparatively poor disinfectant and thus alter the desired dosage requirements.

The free and combined chlorine values are summed together to form “total chlorine”. This assumption is applicable if no organic matter, phenols, or organic nitrogen are present in the water. If this is not the case, stable chlorine compounds can be formed and this relationship is invalid (USEPA 1997).

2.2 Breakpoint

The presence of ammonia and the formation of chloramines also lead to break-point chlorination curves. As stated, chloramines are ineffective disinfectants. Thus the desired free chlorine concentration cannot be obtained until all ammonia has been converted. Figure 18 below provides a representative example of a breakpoint chlorination curve.

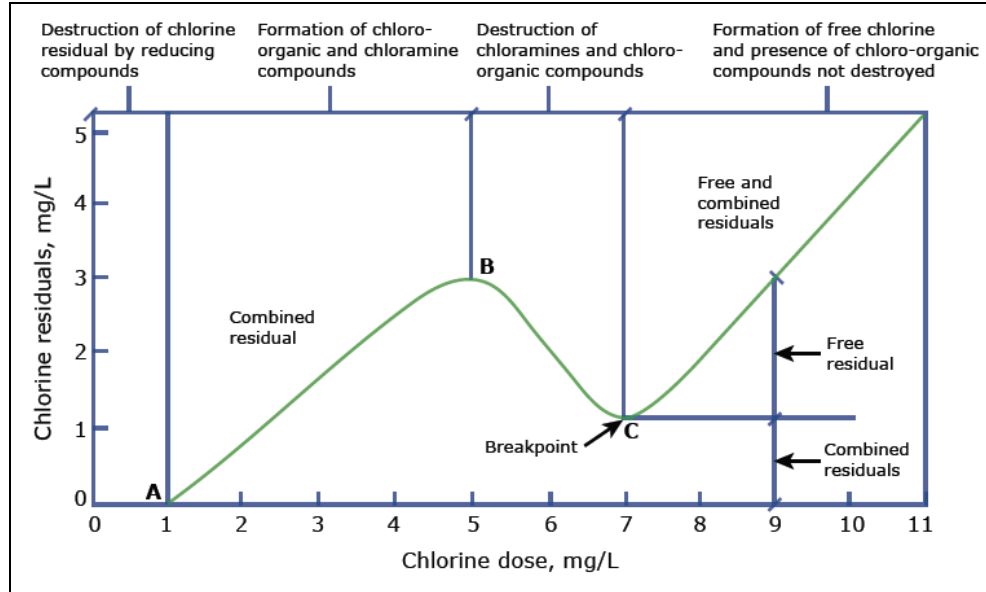

Figure 18: Typical Break-point Chlorination Curve (Metcalf & Eddy 2003)

As shown, chlorine residual concentrations initially increase with chlorine dosing as chloramines are formed (A to B) but then begin to drop as these compounds are slowly destroyed (B to C). The point where all the ammonia has been converted is called the “break-point” (C). After this, additional chlorine leads to higher values of free chlorine (hypochlorous acid and hypochlorite).

Each water source will have its own specific break-point based on pH, water temperature, ammonia concentrations, and contact time. Understanding this relationship is critical to proper disinfection, as the chlorine on the right side of the break-point is 25 times more potent than that of the left side (Harp 1995). Many waters do not have a pronounced dip in the residual curve, but regardless of the shape of the breakpoint curve the presence of free chlorine residual is an indicator of adequate disinfection.

2.3 Chlorine Dose

The chlorine dose needs to be sufficient to provide a desired free residual beyond the water’s demand. The demand is related to the impurities in the water and can vary considerably. The relationship between the two is linear and can be estimated by the following equation (Cairncross and Feachem 1983):

$$\text{Chlorine Demand (mg/L)} = \text{Chlorine Dose (mg/L)} - \text{Chlorine Residual (mg/L)}$$

One thing to note is that even clean water is likely to have a chlorine demand of 2 mg/L (Cairncross and Feachem 1983). In addition, chlorine residual should generally be in the range of 0.3 – 0.5 mg/L with a contact time of 30 minutes (WHO 1997). Taste problems may occur at higher concentrations, and a lower concentration does not provide adequate protection.

2.4 Disinfection By-Products

During the 1970s, it was discovered that reacting chlorine with organic material resulted in disinfection by-products (DBP), and would most likely occur with turbid water. The organics are usually humic and fulvic acids that originate in agricultural runoff and natural vegetation (M20 Manual of Water Supply Practices 2006). The two classes of by-products are trihalomethanes (THMs) and haloacetic acids (HAAs), both of which are suspected to be carcinogenic (M20 Manual of Water Supply Practices 2006).

The risk of such compounds has become a concern since the 1970s and has resulted in the regulation of THMs and the consideration of alternatives to the use of chlorine for disinfection. However, the WHO has said that “the risks to health from these by-products are extremely small in comparison with the risks associated with inadequate disinfection, and it is important that disinfection not be compromised in attempting to control such by-products” (WHO 1993).

2.5 Chlorine Appropriate Situations

Even without considering the health risks of DBPs, chlorine is only appropriate in certain situations. A suitable and steady supply of chlorine must be available. The equipment must be strictly controlled and well-maintained to prevent erratic dosages. There should also be enough time (at least 30 minutes) between the addition of chlorine and the consumption of water. Though residual chlorine will naturally degrade over time, care must be taken to ensure consumption occurs within acceptable ranges. This is likely to be successful when a community has a steady supply of water and adequate storage capacity.

On the other hand, there are circumstances where chlorine disinfection is unsuitable. These include when a regular supply of chlorine compounds cannot be expected, when specific populations are sensitive to DBPs and are likely to encounter them due to the characteristics of the water supply, when elimination of cysts or viruses is desired, or when careful monitoring is not anticipated (Parr et al. 2007).

There are several major important influent parameters necessary for appropriate chlorination. The first is turbidity. As turbidity measurements begin to rise above 5 NTU, the turbidity can begin to interfere with disinfection or give rise to a significant chlorine demand (WHO 1997). As a result, chlorination is often used as the last step in a series of treatments which might include a filtration or biological process in order to ensure appropriate turbidity values. If chlorination is attempted with turbid water, not only will DBPs form, but it will require more chlorine to be as effective. To date there is no easy way to predict an appropriate chlorine dose based on only a known influent turbidity value, although the disinfection process becomes increasingly retarded as the turbidity values rise.

A second important parameter is pH. As shown in Figure 19, by the time the pH has reached a value of 8, nearly 80% of the effective disinfection mechanism of HOCl has been lost. This results from the dissociation sensitivity of the calcium hypochlorite into the less-effective form, hypochlorite ion.

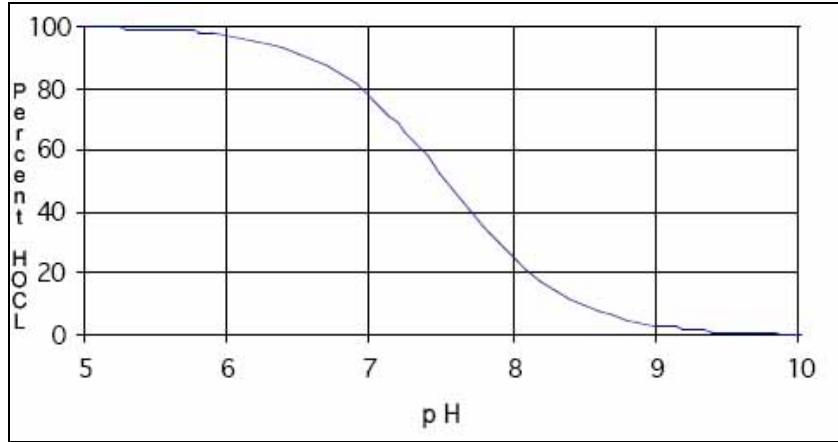

Figure 19: Effect of pH on Percent HOCl Formation (Meyer 2004)

For safety reasons, additional constituents which are a concern if present include organic chemicals such as oils, greases, solvents, and other hydrocarbons. Chlorine reacts with many of these compounds in a violent or explosive way. In addition, chlorine compounds mixed with ammonia can cause potential explosions or toxic chlorine releases and should also be avoided (M20 Manual of Water Supply Practices 2006).

2.6 Analytical Methods

There are numerous tests available for both free and total chlorine. Some of these include diethyl paraphenylene diamine (DPD) colorimetric, DPD titration, iodometric titration, and amperometric titration, FACTS, and electrodes (Harp 1995). The relative precision, analysis range, detection limit, application, and relative skill level required are listed below.

Table 7: Comparison of Analytical Methods for Chlorine ((Harp 1995))

Method	Analysis Range (mg/L)	DL* (mg/L)	Estimated Precision (% RSD [†])	Application	Skill Level [‡]
DPD Colorimetric	0-5	0.005	1-2%	Free and Total	1
ULR-DPD Colorimetric	0-0.500	0.002	5-6%	Total	2
DPD Titration	0-3	0.018	2-7%	Free and Total	2
Iodometric	up to 4%	1	NR	Total Oxidants	2
Amperometric Titration					
Forward	up to 10	0.015	1-2%	Free and Total	3
Back	0.006-1.00	0.006	15%	Total	3
FACTS	0-10	0.1	10%	Free	1
Electrode	0-1	0.05	10%	Total Oxidants	2

* Minimum or Estimated Detection Level
[†] % Relative Standard Deviation
[‡] 1 = minimal training, 2 = moderately skilled with method, 3 = experienced
 NR = not reported

The DPD Colorimetric method has been in use since 1957 and is the most widely used technique for determining free and total chlorine. Essentially, DPD is an amine compound which is oxidized by chlorine into two separate products. At low oxidation levels a purple dye named “würster” is favored, but at higher oxidant levels another compound type called “imine” is formed. The two standard methods used internationally include the *Standard Methods* 4500-Cl G and the International Organization for Standardization (ISO) Method 7393/2, and the latter is more common (Harp 1995). The figure below shows the various structures for each molecule.

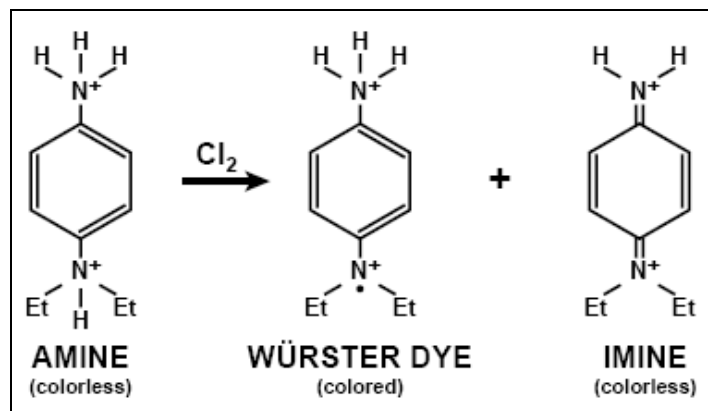
**Figure 20: DPD Reactants and Products (Harp 1995)**

The DPD test can be done several ways such as use of a color wheel or digital titration. The former is a comparison method, meaning that after the free or total chlorine residual solution is made, it is compared to a set “standard”. In this case, it is a color wheel with demarcated values. The latter titration option (Hach Method 8210) works essentially the same as the colorimetric method except that an extra reagent called ferrous

ethylenediammonium sulfate (FEAS) acts to reduce the DPD back to its amine state. Thus the solution will start as a magenta color but then gradually become clearer as more reagent is added. Values for free or total chlorine can be determined by observing how much FEAS has been added.

For this study, four free and total chlorine residual tests were considered: two DPD colorimetric methods, DPD titration, and test strips. The colorimetric tests were 1) the use of a color-disc (Hach CN-70), and 2) a Hach Pocket Colorimeter II Test Kit. The pocket kit was generously loaned by Arch Chemicals for the duration of the study, and Hach Methods 8021 and 8167 were followed for free & total chlorine tests, respectively. After testing and comparing numerous samples in the MIT lab on samples of Charles River water for quality assurance and quality control purposes, the colorimetric disc method was found to be less reliable than the DPD Titration and DPD Pocket Colorimeter methods due to large variability from minimal differences in available light and user interpretation. Figure 21 shows the CN-70 color disc (product #1454200).



Figure 21: DPD Color Wheel

Therefore, the 1) DPD Pocket Colorimeter, 2) DPD titration, and 3) Hach Chlorine Test Singles (test strips) methods were used for all chlorine tests while in Ghana.

2.6.1 DPD Pocket Colorimeter II Method

The Hach DPD Pocket Colorimeter II Test (product #5870000) became the preferred method over the course of this research project because of its high accuracy and short run time. The product must be run in either the low (0.02 to 2.00 mg/L Cl₂) or high (0.01 to 8.0 mg/L Cl₂) ranges. Tests were performed extensively in both ranges and typically started in “high range”, then re-run in the “low range” if a value less than 2.0 mg/L was measured. Figure 22 shows a picture of the Hach DPD Pocket Colorimeter II unit.



Figure 22: DPD Pocket Colorimeter II Test Unit (Hach 2008)

Table 8: Lab Materials Needed for DPD Pocket Colorimeter II Test

DPD Pocket Colorimeter Materials	Product #
Pocket Colorimeter II Unit, including plastic (for high range) and glass (for low range) 10 mL cells	5870000
Powder pillows for free chlorine, 10 mL sample	2105569
Powder pillows for total chlorine, 10 mL sample	2105669
Graduated cylinder (or alternative way to accurately measure 10 mL)	

The procedure below describes the key steps in the test procedure as drawn from the Hach *Method 8021* for free chlorine and *Method 8167* for total chlorine.

1. Cell Cleaning

- Ensure the cells (plastic for high range and glass for low range) are thoroughly cleaned with soap and water and dried before use.

2. Running the Blank

- Fill a 10 mL cell with the sample and cover with lid. Turn on the colorimeter unit and put into correct range setting (high or low).
- Place the blank in the cell holder, cover, and press the “zero/scroll” button. The display should now read “0.00”.

3. Reading the Sample

- Fill another 10 mL cell with the sample, and add the contents of one DPD powder pillow (low range setting) or two pillows (high range setting), as appropriate.
- Cap and shake gently for 20 seconds.
- For free chlorine, read sample within 1 minute after adding the DPD pillow. For total chlorine, wait three to six minutes before reading sample.

- Press the “zero/scroll” button and read measurement. If the value lies outside the recommended range, alternate the high/low setting as appropriate and redo the test.

Figure 23 shows Step 3, where the DPD powder pillow is being added to the cell, and will subsequently be placed into the pocket colorimeter for measurement.

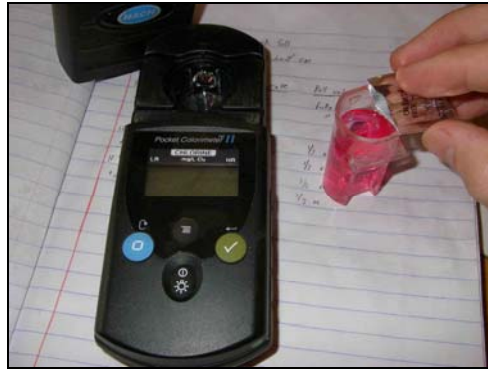

Figure 23: Pocket Colorimeter Testing Methodology

2.6.2 DPD Titration Method

The DPD Titrator was expected to be the primary analytical method for chlorine residual testing at the beginning of the field study based on the availability of this device in the MIT lab. Another reason was the author did not receive the loan of the Pocket Colorimeter until arrival in Ghana, where it was determined to be a more appropriate testing method due to its accuracy and simplicity. Figure 24 shows the DPD Titrator unit in use.



Figure 24: DPD Titration

Table 9: Lab Materials Needed for DPD Titration Test

DPD Digital Titrator	Product #
Hach Digital Titrator (including a delivery tube with a 180 degree hook)	1690001
Ferrous Ethylenediammonium Sulfate (FEAS) Titration Cartridge, 0.00564 N	2292301
Powder Pillows for Free Chlorine, 25mL sample	1407099
Powder Pillows for Total Chlorine, 25mL sample	1406499
Graduated Cylinder (or alternative way to accurately measure 25mL)	
Graduated Erlenmeyer Flask, 50 mL	
25 mL Pipet	

The procedure below is a summary from Hach *Method 8210*.

1. Glassware & Delivery Tube Cleaning

- Ensure the delivery tube and all glassware (graduated cylinder and flask) are thoroughly cleaned with soap and water.

2. Titrator Assembly

- Insert a clean delivery tube into a FEAS cartridge and install onto the Titrator.
- While holding the Titrator with the cartridge pointing up, turn the delivery knob until a few drops of titrant have been ejected.
- Reset the counter to zero.

3. Reading the Sample

- Use a pipet to measure 25 mL of the sample into a clean 50 mL Erlenmeyer flask.
- Add the contents of one DPD Chlorine Pillow (Free or Total, as appropriate). Swirl to mix. For total chlorine measurements, wait three minutes before proceeding.
- Place the delivery tube into the solution and swirl the flask while turning the knob on the Titrator. Continue to add titrant until the solution becomes clear.
- Obtain the result by reading the final value displayed on the counter. For free chlorine measurements, divide the value by 100. For instance, a reading of 250 would result in a free chlorine residual concentration of 2.50 mg/L Cl₂. For total chlorine measurements, no alteration of the final value is needed.

Overall the titration method was used mainly for quality assurances only but would have been equally appropriate if the Colorimeter wasn't available. The reasons why it wasn't preferred were it required more reagents, more work to complete, and was more limited in its range (only 0.0-3.0 mg/L) while giving almost the same results for both free and total chlorine residual. Figure 25 shows a comparison of the same water sample taken in Ghana using both methodologies.

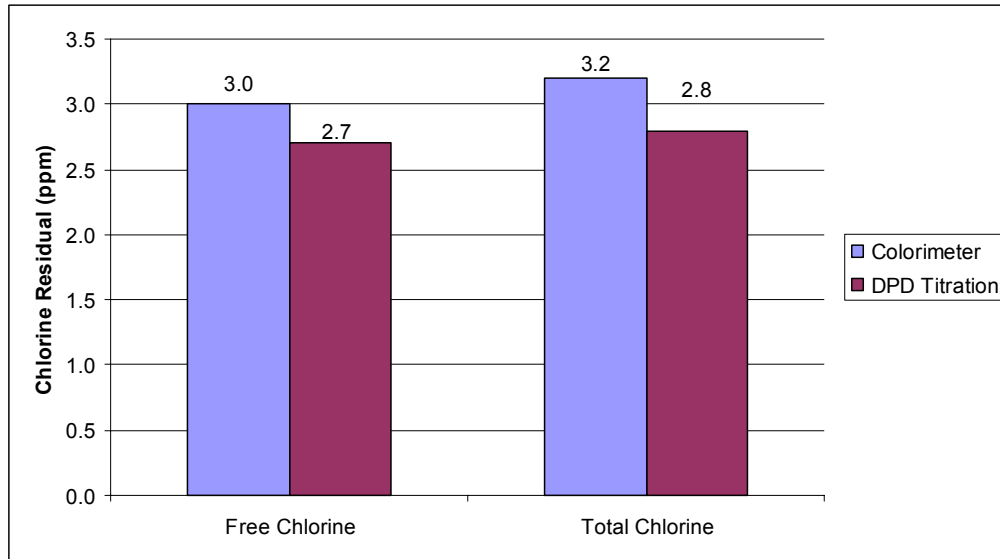

Figure 25: Comparison of DPD Titration and Pocket Colorimeter II Methods

As this Figure shows, the two methods resulted in comparably similar values, although the Colorimeter values were slightly higher in both (free and total chlorine) cases. Of the two methods, the Colorimeter is also supposed to have both more precision and a lower detection limit (see Table 7).

2.6.3 Hach Chlorine Test Strips Method

The Hach test strips (product #2793944) were used primarily for either “presence/absence” of residual chlorine purposes or to shorten the length of dilution testing. For high chlorine concentrations with unknown values, frequent dilutions became necessary. Since the other two residual tests took much longer, the test strips were used to quickly assess if diluted solutions were within appropriate ranges for the other methods. Figure 26 shows the package containing 250 test strips and a couple of individual singles.



Figure 26: Hach Chlorine Foil Singles

Use of the Hach test strips is straight-forward and has the advantages of not requiring any measuring, setup, cleanup, or chemical handling. By simply placing the strip directly in a water sample or under a running tap, the user can make a quick assessment of both free & total chlorine residual by comparing the strip color to the provided values. The drawback of these test strips are the low precision and subjectivity of user interpolation since the provided colors are only for 0.0, 0.5, 1, 2, 4, and 10 mg/L.

2.6.4 Other Non-Chlorine Testing Methods

Some other water quality parameters such as pH and turbidity were also measured during the pilot study to ensure the influent water met various criteria (see Section 2.5). For pH, the use of Hach pH test strips (product # 2745650) was used.



Figure 27: Hach pH Test Strips Used

Turbidity measurements were also taken using a turbidity tube, which requires the user to place well-mixed water into the tube while looking down and determining when the “bulls-eye” at the bottom is no longer visible. At this point the value on the side of the tube is measured where the water height is. One limitation of this technology is that its lower limit is 5 NTU, which fortunately also corresponds to the WHO recommended limit for by-product formation from chlorine dosing (Section 2.5). Figure 28 shows the two segments of the turbidity tube which must be snapped into one piece prior to use.

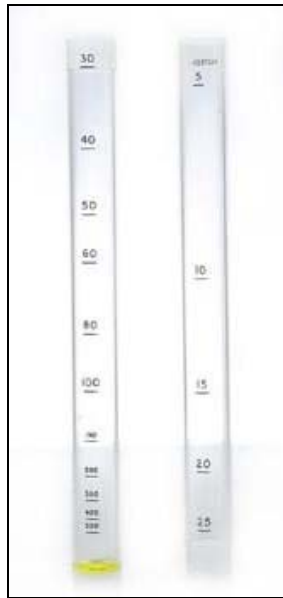

Figure 28: Turbidity Tube Used

3.0 Methodology of Testing Community-Scale Water Disinfection Using Chlorine

3.1 Field Study Background

The three week long field study was conducted from January 4th to 25th in Tamale, Ghana. The location was selected because of the serious drinking water pollution in the area and the availability yet minimal use of chlorine for water disinfection beyond the municipally treated Ghana Water Company water supply. Figure 29 shows the location of Tamale.



Figure 29: Location of Tamale Within Ghana (Globe Media Limited 2007)

The author's research was coordinated with Master of Engineering student A. Swanton who was studying the efficacy of household chlorination technologies with the Kosim filter. Activities such as interviews of locals and their chlorine taste preferences were of combined interest and were thus sometimes conducted jointly. Fortunately Tamale was also a suitable place for that work because there were several nearby villages with Kosim filters currently in use.

The majority of the author's field research and lab work was conducted at a regional Peace Corps office located within Tamale, often referred to as the Tamale Sub Office (TSO). MIT obtained approval to use the premises prior to arrival, and three students (author included) used it as their primary field lab site.

3.2 Field Study Design and Methods

3.2.1 Site Selection

One of the challenges to undertaking a field study of a community scale chlorination system in Northern Ghana is that water is scarce and community supplies cannot be “turned off” for a one-month study. Care must be taken to ensure the users have an available and dependable alternate source of drinking water while the chlorination system’s on-site efficacy is determined. Along these lines, the concern was that installing a chlorination system for research purposes would likely result in highly variable free chlorine residuals, resulting in either inadequate protection from microbial contamination or elevated chlorine levels. In addition, the need for sufficient quantities and quality of water to run the necessary tests was also considered.

The manager of the Peace Corps office was kind enough to allow the author to disconnect one of the office’s four water storage tanks (called polytanks) and keep it separate for research purposes for the duration of the project. The tank volume was approximately 350 gallons¹ and was located on an elevated platform outside in the back yard but still within the compound walls. This security was important because it prevented tampering or theft. Figure 30 shows a picture of the elevated tank used for source water.



Figure 30: Source Water From Elevated Tank in Tamale

¹ Since Ghana was a former British Colony, they use British units. English units are used throughout this report. A conversion table is provided in Section 10.1.

3.2.2 Field Site Source Water

The influent water within the tank came from two different sources. The primary source was municipally piped water from the Dalun Water Treatment Plant, which was supposed to flow once a week on Tuesday nights. However, while this was typical, it was not guaranteed. It twice became necessary to hire a private vendor to bring a water delivery truck which would pump into the tank when either the piped water didn't flow or the tank ran dry during research prior to the following Tuesday.

The elevation of the top and bottom of the polytank was 16.4 ft and 11 ft, respectively. Figure 31 shows the inlet and outlet pipes on the elevated tank.

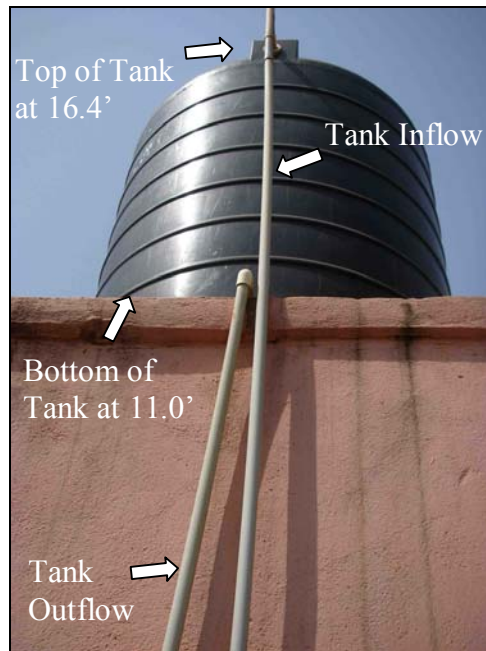

Figure 31: Position and Height Measurements of Elevated Tank in Ghana

The entire system was gravity-fed once pumped into the elevated tank. The diameter of the PVC pipe connecting the elevated tank to the Pulsar unit went from $\frac{3}{4}$ " to 1.5" to accommodate existing piping. Flow from the elevated storage tank was controlled by turning a 1.5" ball valve. This configuration resulted in a flow rate of about 18 gallons per minute (gpm) when opened fully. Figure 32 shows the various PVC pipes and fittings discussed above.

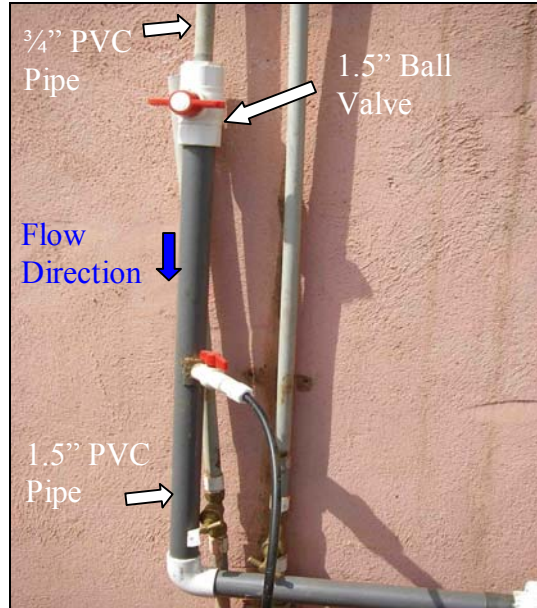

Figure 32: PVC Connections from Elevated Tank to Storage Tank in Ghana

3.2.3 Influent Turbidity, pH, and Chlorine Residuals

Many water supplies in Northern Ghana contain very high turbidities (average of approximately 700 NTU) (Foran 2007). This is unacceptable for chlorination treatment and thus this pilot study. Given this backdrop, the influent water quality (which was unknown in advance) of the municipally treated piped water was much better than anticipated. The turbidity, as measured with a turbidity tube, was found consistently to be <5 NTU, the pH was measured with test strips and found to be about 6, and the chlorine residual was also confirmed to be zero with test strips and the digital titrator. All of these values suggest there was a minimal amount of interference with the chlorine residual tests. Table 10 below shows the results of turbidity, pH, and free & total chlorine measurements based on duplicate samples which exactly matched the originals.

Table 10: Water Quality of Tamale Municipally Piped Water at Peace Corps Office

Parameter	Testing Method	Result
Turbidity	Turbidity Tube	<5 NTU
Test Strips	Free Chlorine	0 mg/L
Test Strips	Total Chlorine	0 mg/L
Digital Titrator	Total Chlorine	0 mg/L
Test Strips	pH	6

3.2.4 Chlorine Demand of Influent Water

The chlorine demand of the water was determined early on. To compute this, a solution with a known concentration was prepared. This was done using 3.5% strength bleach (sodium hypochlorite). Solutions were prepared and measured using the tap and local bottled water (Voltic) for quality assurance. The specific solutions were made by pipetting 0.1mL of bleach into 700mL of clean water. 3.5% bleach translates to 35,000 mg/L of chlorine. The following equation shows how the predicted theoretical chlorine concentration should be 5.5 mg/L.

$$\left(\frac{35,000\text{mg}}{L}\right) \times \left(\frac{.1\text{mL}}{700\text{mL}}\right) = \frac{5\text{mg}}{L} \times \left(\frac{1.1\text{ specific gravity of bleach}}{1.0\text{ specific gravity of water}}\right) = 5.5\text{mg} / L$$

As previously stated, even clean water will have a certain amount of chlorine demand, so the expected measured chlorine concentration value will be lower than the predicted concentration above. One unexpected surprise was the bottled water had a substantially higher demand than the tap water (3.2 mg/L versus 2.0 mg/L, respectively), which seems counterintuitive because one might assume the bottled water is cleaner. The discrepancy is likely due to the bottled water having certain inorganic salts which are not present in the tap water. Although the Voltic bottled water does not specify constituents or concentrations, it does say that certain “minerals” are present. Figure 33 below shows the local bottled water and bleach used for determining chlorine demand.



Figure 33: Local Bottled Voltic Water and Bleach (3.5%) Products Used in Ghana

Figure 34 below shows the chlorine demand of both the tap water and the local bottled water. Both measurements were analyzed using the same method (DPD Titration) and based on the average of triplicate tests.

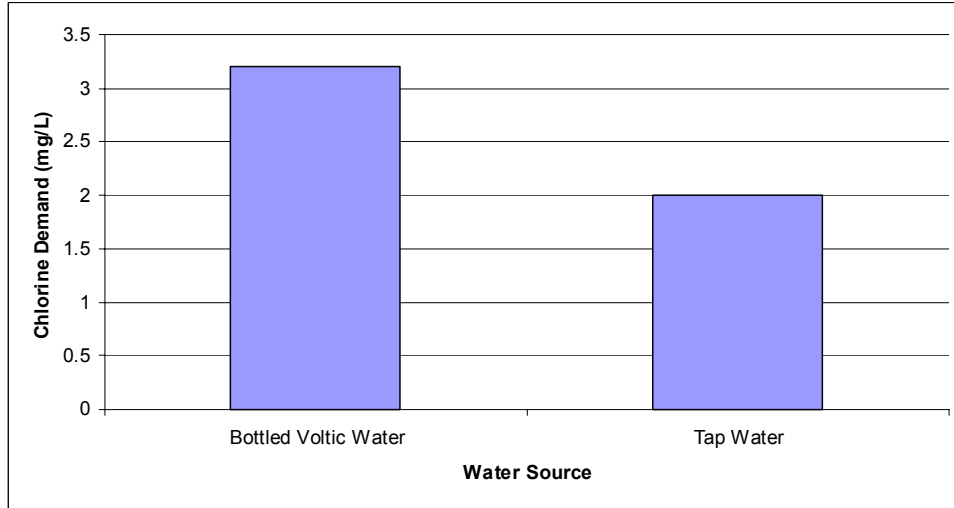

Figure 34: Chlorine Demand Comparison of Tap and Local Bottled Water in Tamale

It was thus decided that the tap water should be used for all further dilutions and lab testing since it would likely pose a smaller interference with the chlorine residual tests.

3.2.5 Determining Flow-rate of the System

In order to predict the output concentrations and to better understand the system, the flow rate needed to be determined. This was accomplished by direct measurement. As previously mentioned, the system flowed by gravity from the elevated tank into the storage tank while the Pulsar system ran in parallel (see Figure 31, Figure 35, and Figure 38). For flow rate measurements, the Pulsar unit was disconnected from the system to avoid splitting up the flow. Figure 35 shows the configuration and the direction of water influent to the storage tank.



Figure 35: Configuration and Flow Direction of System

To ascertain the flow rate, the internal diameter of the storage tank was first measured using a tape measure. The system was then allowed to fully flow and periodic time & water height measurements were taken. The following expression was then used to determine the flow rate.

$$\text{Flowrate} = Q = \left(\frac{\pi \times [\text{radius}]^2 \times [\text{height}]}{\text{time}} \right)$$

After the calculations, the flow rates were then averaged to find a mean value. This was also performed to “smooth out” any outlier measurements.

3.2.6 Effect of Runtime on Pulsar System

One hurdle to obtaining all the required data was having a finite limit of source water. As previously stated, 350 gallons of water were delivered once a week into the polytank. It was originally thought the Pulsar unit needed to be running for “at least a few minutes” to equilibrate. Thus every measurement would require a few minutes of runtime, and at a flow rate of several gallons per minute (see Section 3.2.2) the research could have been seriously restricted by a shortage of influent test water. In order to test the Pulsar’s reliance on a few minutes of runtime, the unit was allowed to equilibrate for several minutes with no chlorine, then chlorine was abruptly added and chlorine residual measurements were taken every 30 seconds. If the system was shown to equilibrate faster than anticipated, then the author would be able to conduct more testing with less water.

Figure 36 below shows where the water samples were taken, which is right after mixing and *before* entering the storage tank. Measuring *after* the storage tank would have been a

misrepresentation because its influent values could likely adjust suddenly through operator control, which would then allow different concentrations to mix and thus change the effluent concentration.



Figure 36: Measurement Location for All Pulsar Data Values

3.2.7 Modifications to Pulsar 1 Unit

While using a Pulsar unit has such advantages as no required power, ability to be gravity-fed, and more accurate dosing than the Sanikit, it does have its limitations. As previously mentioned, it is designed to chlorinate swimming pools which already have high chlorine demands and to keep chlorine residual concentrations higher than appropriate drinking water standards. Although it may be possible to offset these factors with a large enough water supply, the available water system in Tamale was a small tank (roughly 350 gallons) with low chlorine demand water. Thus the Pulsar unit would naturally overdose with chlorine concentrations much greater than drinking water standards, which necessitated a way to decrease the values. One of the main objectives of the pilot study is to determine whether it is possible to achieve these reductions in free chlorine residual concentrations by modifying the Pulsar unit.

3.2.7.1 Modifications Made in Ghana

The easiest and most logical way of decreasing the concentrations was to reduce the amount of water contact with the chlorine in the dissolving cup. This was achieved by using a raised grid which contained 1/4" spikes, which essentially required the water height in the cup to be higher to achieve the same chlorine output. Arch had conducted some tests with the new spiked grids and recorded how concentrations varied depending on flow. Table 11 below shows their results.

Table 11: Chlorine Outputs for 1/4" Raised Grid Based on Flow Rate (Blanchette 2007a)

Pulsar Flowrate (gpm)	Chlorine Residual (mg/L)
0.2	1790
0.4	780
0.6	900
0.8	890

The next two modifications were made in conjunction to provide additional lowering of concentrations. The first part was to add a dilution nozzle assembly (DNA) inside of the Pulsar unit which was placed between the emergency shutoff valve (ESV) and the dissolving cup. Its purpose was to divert a portion of the incoming water away from chlorine contact, which would lower the water level in the dissolving cup and dilute the output concentrations. There was also a valve placed on the DNA to control dilution. Figure 37 below shows the gray dilution nozzle assembly (DNA) piece hooked directly into the blue dissolving cup. Notice the arm valve's current position which allows for full dilution. A 90 degree clockwise turn on the valve would completely block water to the DNA and thus not divert any water into the dissolving cup, which would entirely negate the dilution nozzle's effect.

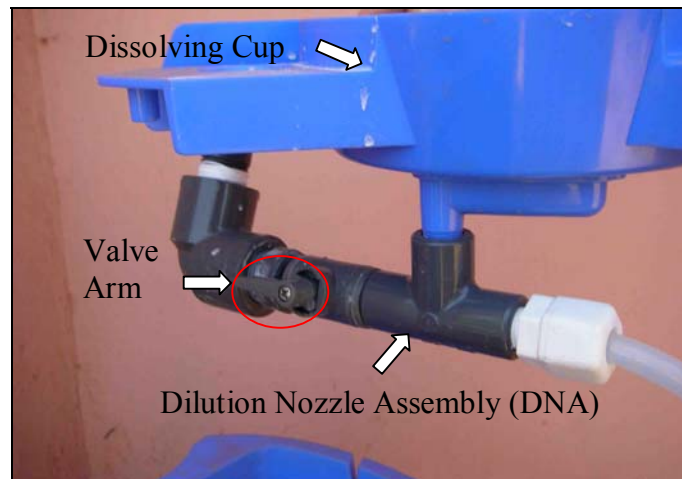
**Figure 37: Dilution Nozzle Assembly (DNA) on Pulsar Unit in Ghana**

The second adaptation was to modify the emergency shutoff valve (ESV) part itself to allow more inlet flow. While this may seem counterintuitive because more flow into the Pulsar would result in higher concentrations, this alteration was made knowing a significant portion of the flow would be diverted away from the dissolving cup through the DNA. This modification was also necessary because scaling blockage becomes a concern when the flow rate through the Pulsar unit falls below recommended operational values (the aqueous chlorine solution begins to dry and harden). This alteration was

accomplished by Arch, who changed the part's valves to increase the inlet flow (Blanchette 2007b).

When even these three modifications could not achieve low enough concentrations, the fourth and final adjustment was to partially close the inlet & outlet valves to the Pulsar. Its effect would be to reduce the amount of water coming both in and out of the Pulsar, which would reduce the overall concentration. Figure 38 below shows the location of the inlet and outlet valves on the main line.

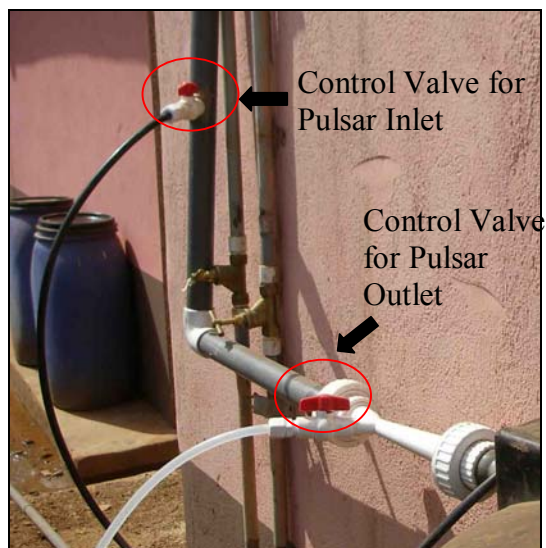

Figure 38: Location of Pulsar Inlet & Outlet Ball Valves

3.2.7.2 Additional Adjustments Made While in Cambridge

To continue alternate ways of adapting the Pulsar unit for drinking water, further research was conducted at MIT in Cambridge. Controlling the inlet & outlet flows of the Pulsar unit from the ball valves in Ghana (modification described above) had distinct disadvantages, so alternate means of obtaining the same objective still needed to be found.

The modifications made at the MIT lab in Cambridge were based on the successful aspects from the Ghana field study, and in most ways simply took them further. Specifically, the emergency shutoff valve (ESV) and dilution nozzle assembly (DNA) parts were enlarged. Figure 39 below shows the new parts installed within the Pulsar 1 unit.

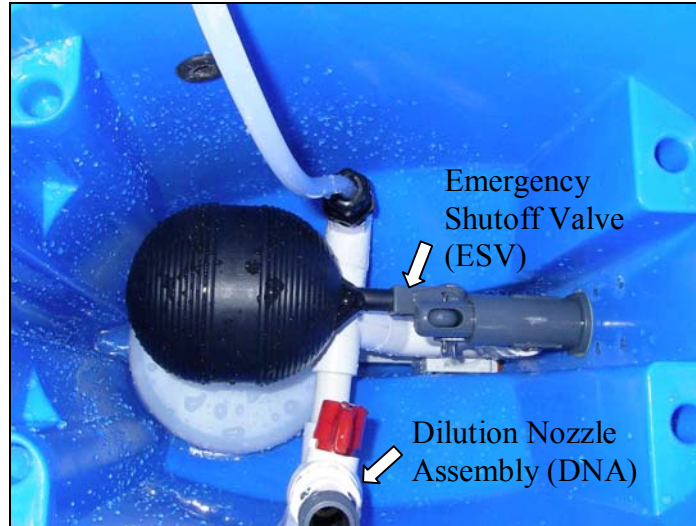

Figure 39: Emergency Shutoff Valve (ESV) & Dilution Nozzle Assembly (DNA) Modifications Tested in Cambridge

The purpose of these additions was to simultaneously increase the flow rate (modified ESV which allowed more flow) into the Pulsar unit while diverting more away (altering the DNA) from the dissolving cup. The net effect was increased dilution potential which decreased the free chlorine residual concentrations even further than that offered by the spiked grid alone.

4.0 Results & Analysis of Ghana Research

This section discusses the results of tests that were conducted on the Pulsar system in Tamale, Ghana. The test results are summarized as graphs in this chapter and the raw data can be found in Appendix B.

4.1 System Flow-Rates

As discussed in Section 3.2.5, the flow-rate of the elevated tank into the storage tank was measured. Three separate flow trial runs were conducted and the average flow-rate was found to be 18.1 gallons per minute (gpm). The largest deviation (trial #2) came out to be 2.8% from the average.

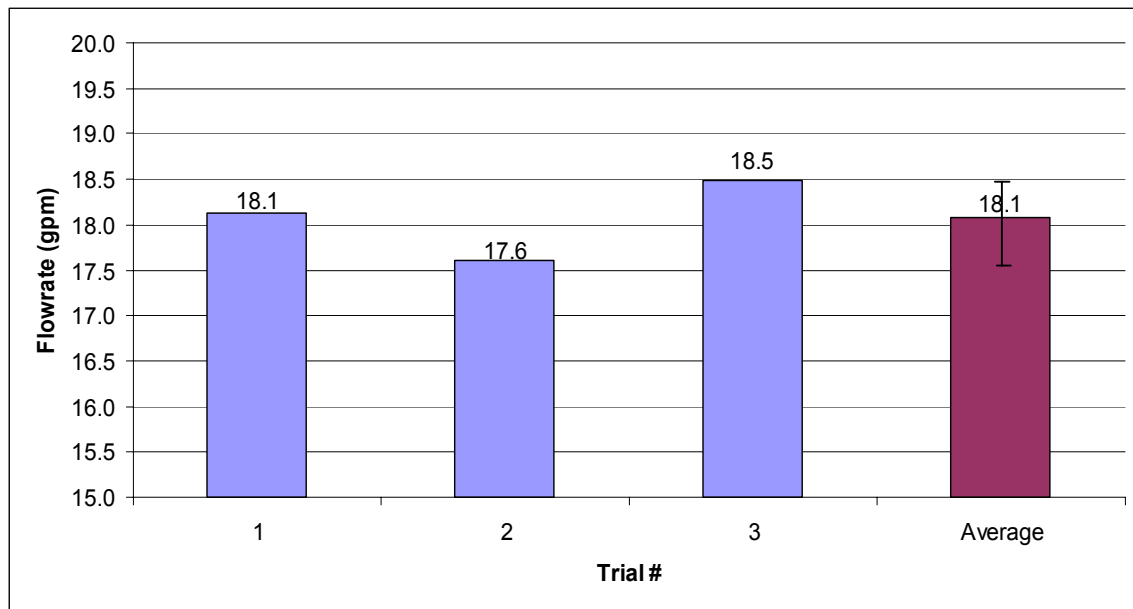

Figure 40: Flow-Rates From Gravity-Fed Tank in Ghana

As previously mentioned, all measurements were taken while the gravity-fed tank was relatively full (>2/3). Flow-rates were observed to be considerably less when the tank was significantly empty.

4.2 Decay Rates of Chlorine Residual Over Time

In an effort to understand and predict the storage characteristics (chlorine demand and decay over time) of the local tap water, measurements were taken on two different starting chlorine doses, one low (2.7 mg/L) and one high (40 mg/L). It was expected that the chlorine decay would follow an exponential curve, as predicted by theory (Hua et al. 1998). The author used only free chlorine tests to take these measurements, knowing that

free chlorine is strongly correlated to total chlorine concentrations. The length of time measured was 8 days.

A larger number of measurements were taken near the onset of the chlorine demand tests because of large anticipated decay rates which never materialized. Though consistent data was taken for over a week for both runs, expected storage times by consumers would likely be far less. Thus these results are expected to present a worst-case scenario. Figure 41 shows how the low batch degraded over 8 days. Note that different scales are used in the following two figures to better visually represent the data.

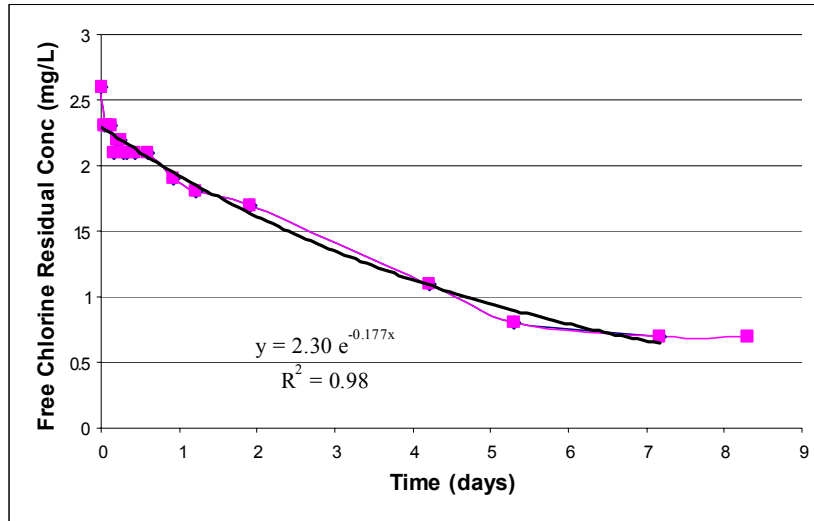

Figure 41: Free Chlorine Residual vs. Time (Low Concentration Batch)

Figure 42 shows how the high batch degraded in the tap water over a span of a little over eight days.

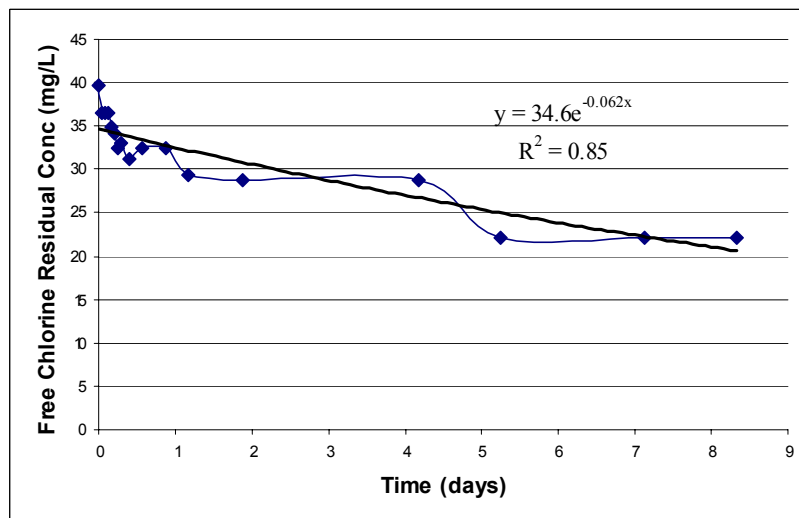

Figure 42: Free Chlorine Residual vs. Time (High Concentration Batch)

As predicted, both the high and the low concentrations demonstrated exponential decay, although the low chlorine batch followed it much more closely. The R^2 values for the low and high chlorine batches were 0.98 and 0.85, respectively. Since the high concentration batch was measured from a 1:5 dilution (one part sample with five parts water), the measured values may not be as precise as for the low concentration batch.

Though the curves on Figure 41 and Figure 42 look similar, the high concentration batch is actually degrading much faster because of the elevated starting values. The most noticeable difference between the two figures' trends takes place in day 4, where the high concentration batch stays constant for two days and then drops sharply in the next day. This is likely an aberration which reflects the difficulty associated with obtaining precise measurements with high dilution (1:5 in this case).

4.3 Effect of Pulsar Runtime on Free Chlorine Residual

The results of the experiment described in 3.2.6 on the effect of Pulsar runtime on residual chlorine are shown below in Figure 43.

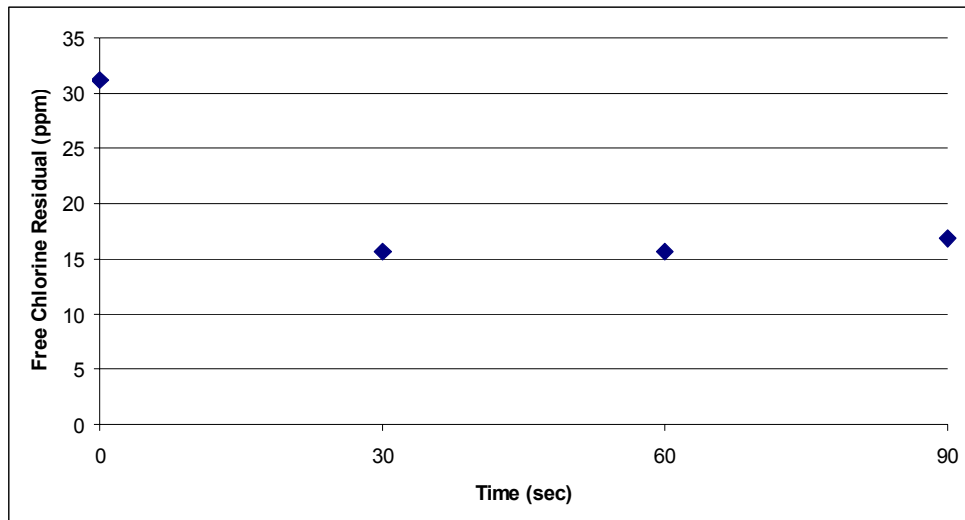

Figure 43: Effect of Pulsar Runtime on Free Chlorine Residual Concentration

The residual values themselves are relatively unimportant in this figure compared to the trend, which clearly shows the chlorine residual concentrations leveling off. As shown by Figure 43, 30 seconds was enough time to allow the Pulsar unit to equilibrate to a system change which took place at $t=0$. Although this result was reconfirmed by other runs at different starting values, almost all the data taken and presented in the results section were after at least 60 seconds of runtime to remain conservative.

4.4 Effect of “Original” Dilution Nozzle Assembly (DNA) on Free Chlorine Residual

The dilution nozzle assembly used in Ghana was described in Section 3.2.7.1 and shown in Figure 37. In order to be assured of data precision, four separate trials were run. Fully closed was 0%, 1/3 opened was 33%, 2/3 opened was 66%, and fully open was 100%. For instance, each of the four data points under 0% corresponds to a different trial. The results of the dilution nozzle assembly used in Ghana are shown below in Figure 44.

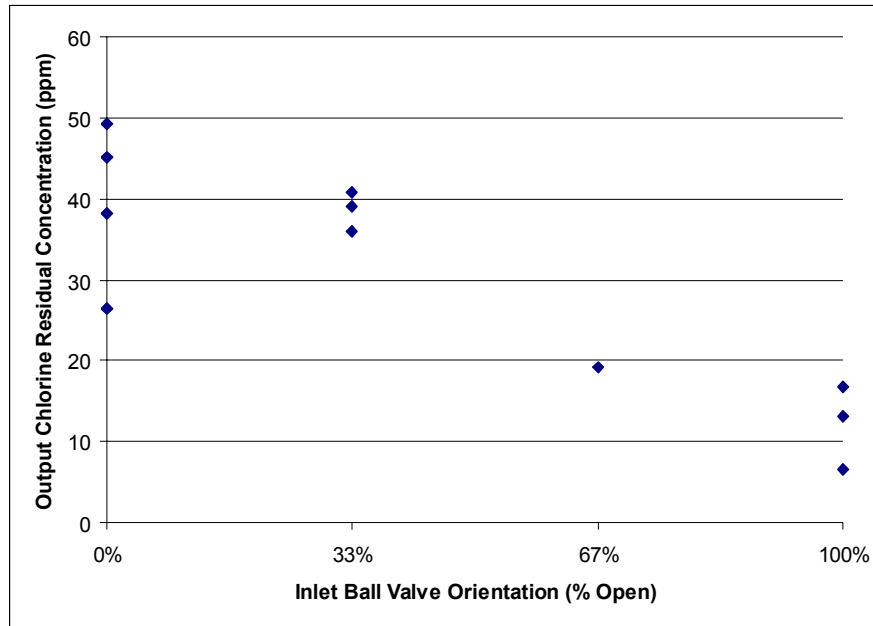

Figure 44: Range of Output Concentrations from the Dilution Nozzle Assembly (DNA)

While the results are not perfect, the trend clearly shows as the inlet ball valve was increasingly opened, the output concentrations decreased. This matches expectations because as more flow is diverted away from the dissolving cup, the water level will drop and less water will contact with the HTH.

Having the dilution assembly running at 100% resulted in a free chlorine residual range of 6.6 mg/L to 16.8 mg/L, which is still far too high for drinking water. Therefore, additional measures to reduce the output levels even further still needed to be taken.

4.5 Effect of Ball Valve Modification on Chlorine Residual

The final modification to the Pulsar system was described in Section 3.2.7.1 and involved partially closing the inlet and outlet ball valves shown in Figure 38. All tests were run with the dilution nozzle assembly (DNA) at 100% to provide its maximum dilution. In addition, all the measurements in Figure 45 were taken 60 seconds after altering the ball

valve orientation to allow the Pulsar unit sufficient time to equilibrate. As before, 0% corresponds to the valve being fully closed and 100% means fully open.

Turning the inlet and outlet ball valves to a precise orientation and then having to duplicate it later turned out to be very difficult. As such, flow measurements were taken on the inlet to the Pulsar unit to ensure each test corresponded to the same inlet flow rates. Figure 45 below shows the ball valve’s affect on the Pulsar’s inlet flow.

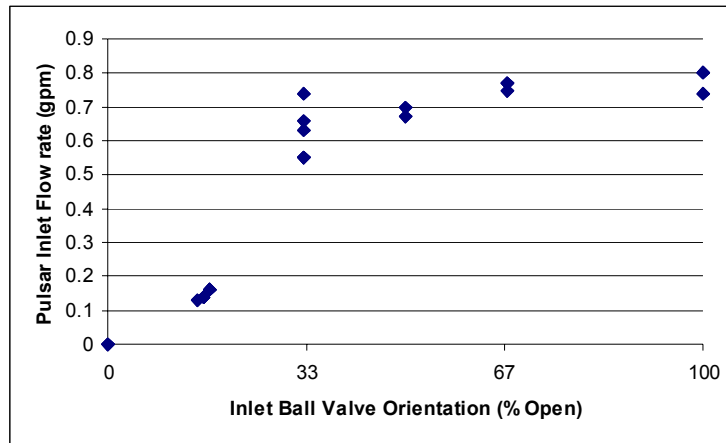

Figure 45: Inlet Ball Valve Orientation vs. Flow Rate

The results of this figure clearly show there was a significantly wider variability of flow rates corresponding to the higher percent open orientations above 33%. This was expected since the two orientations below 20% (fully off and barely on) were both easy to duplicate while the others were not.

The increased precision of the lower range values (0% and 20%) were also reflected in Figure 46 below.

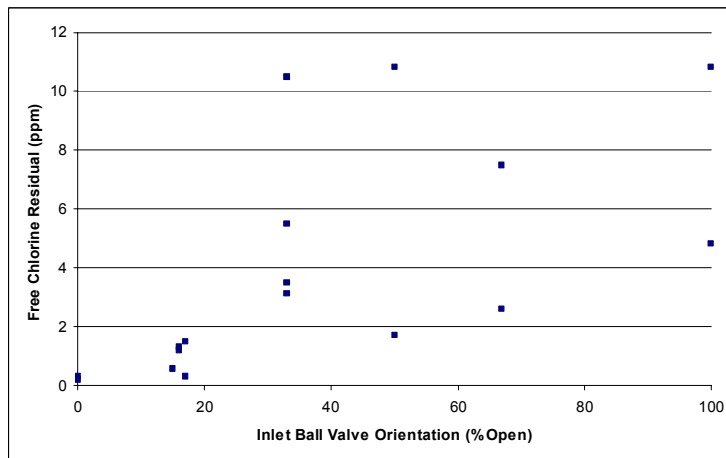

Figure 46: Effect of Inlet Ball Valve on Chlorine Residual Concentration

There was a considerable range of values for any of the orientations above 33% open, and this is representative of the sensitivity of the system to even the small flow rate changes observed in Figure 45. This sensitivity demonstrates the difficulties in accurately diluting a very strong concentration. Even a small alteration in the flow to the dissolving cup corresponds to a large difference in free chlorine residual output.

One success of this technique was that chlorine residual output concentrations were successfully lowered to approximate drinking water standards of no greater than 2.0 mg/L after 30 minutes and at least 0.2 mg/L after 24 hours of storage for the “barely on” (below 20% orientation) measurements. The range of values (0.3 to 1.3 mg/L) fell within the target range. However, this method of achieving the desired free chlorine residual concentration should also not be considered a long-term solution because reducing the flow through the Pulsar to this low level will quickly result in scale formation, which will lead to frequent blockage and maintenance.

5.0 Results & Analysis of Cambridge Lab Research

As previously mentioned in Section 3.2.7.2, additional research was conducted at the MIT lab in Cambridge to continue testing of the Pulsar 1 unit for further reductions in free chlorine residual concentrations. The same analytical methods were used to ensure the data was comparable, and much of the methodology was similar to the fieldwork in Ghana.

5.1 Cambridge Influent Water Parameters

Since the piped water quality in Ghana was surprisingly clean because we were using municipally treated water to conduct the pilot study, many of the key parameters remained approximately the same for Cambridge. A summary of the measured values are listed below.

Table 12: Water Quality of Tap Water at MIT Lab in Cambridge, MA Compared to Ghana

Cambridge				Ghana		
Parameter	Testing Method	Result		Parameter	Testing Method	Result
Turbidity	Turbidity Tube	<5 NTU		Turbidity	Turbidity Tube	<5 NTU
Colorimeter	Free Chlorine	0.15 mg/L		Colorimeter	Free Chlorine	0 mg/L
Colorimeter	Total Chlorine	1.0 mg/L		Colorimeter	Total Chlorine	0 mg/L
Test Strips	pH	7		Test Strips	pH	6

The key difference between the water in Cambridge, MA versus Ghana is the presence of a small chlorine residual (0.15 mg/L and 1.0 mg/L free and total chlorine respectively), which is common for municipally piped water in the United States but was not present in the municipal water obtained from the Ghana Water Company in Tamale, Ghana.

5.2 Cambridge System Flow Rates

The laboratory water tank in Cambridge had considerably less volume and flow rate compared to the Ghana system. This created certain challenges because all of the Cambridge Pulsar data was taken at flow rates even lower than Ghana, which was already problematic.

Similar to Ghana, the influent tank was gravity-fed. In the lab, the height difference from the top of the elevated tank to the Pulsar inlet was about 4.3 feet². The flow was controlled by a 1.5” ball valve. The internal diameter and height were 2 feet and 1.3 feet, respectively. The volume was thus approximately 41 gallons. Figure 47 shows a picture of the tank in the MIT lab.

² For a conversion from feet of head to other standard atmospheres, see conversion table in Section 10.1.



Figure 47: Influent Tank for Pulsar 1 System at MIT lab in Cambridge, MA

Having a small tank provided some limitations. It required filling after every test run, which resulted in frequent downtime. It was also only possible to run for a maximum of about 5 minutes until the tank became empty.

Figure 48 below shows how the flow rate measurements changed over time for the gravity-fed tank in Cambridge.

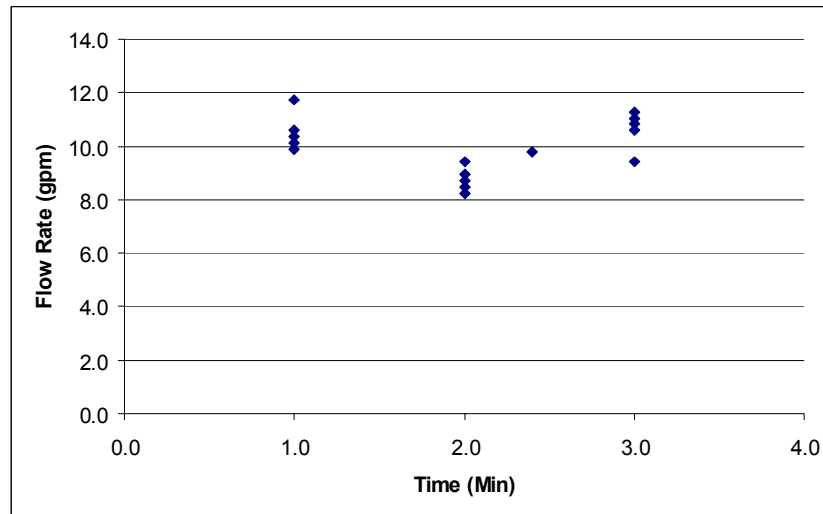

Figure 48: Flow-Rates From Gravity-Fed Tank in Cambridge

As the data shows, the flow rates were measured to be fairly reproducible at an average of about 9 gpm. Although theory would dictate that the overall flow rate trends should decrease as the tank emptied and gravity pressures decreased, this was repeatedly not measured to be the case.

5.3 Effect of Pulsar Runtime and “Newer” Dilution Nozzle Assembly on Chlorine Residual

As previously discussed in Section 3.2.7.2, the two modifications shown in Figure 39 include a larger Emergency Shutoff Valve (ESV) to increase flow into the Pulsar with a larger Dilution Nozzle Assembly (DNA) to divert more water away from the contact chamber. The overall result is additional dilution capacity, which is particularly important for the very small flow rates (approximately 9 gpm) observed in the Cambridge system setup.

Figure 49 shows the measured free chlorine residual concentrations. All data points were taken with a 1/4” spiked grid installed and the new modified DNA ball valve fully on to achieve maximum dilution.

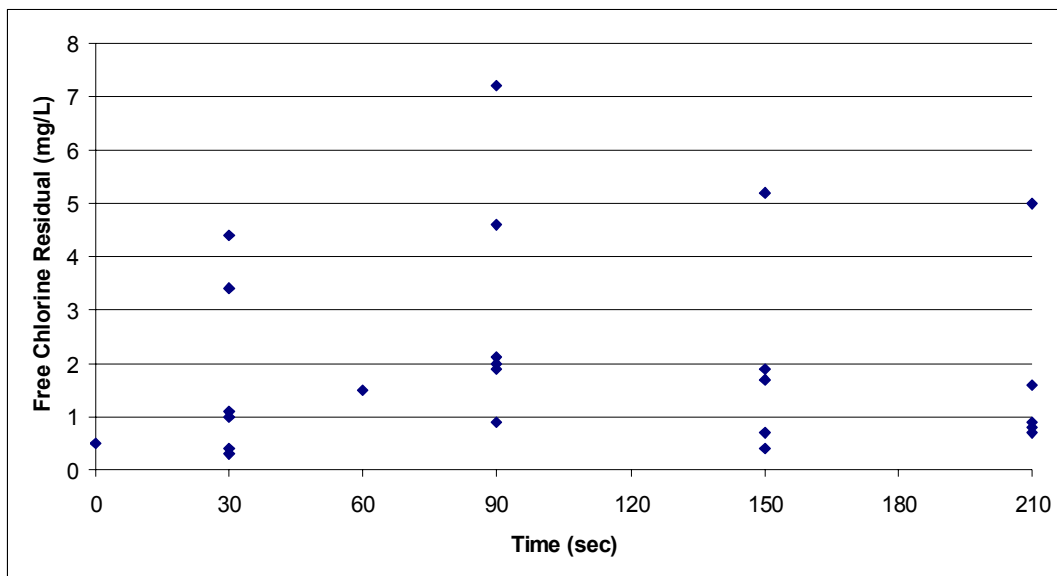

Figure 49: Chlorine Residual Concentrations Over Time With “Newer” Pulsar Modifications in Cambridge

The results show that the new parts (DNA & ESV) were fairly successful in lowering free chlorine residual concentrations to below 2.0 mg/L. The values are actually even more encouraging because all the high values occurred in the first few trials. This fact is displayed in Figure 50, which shows the same data as before but broken up by Trial number.

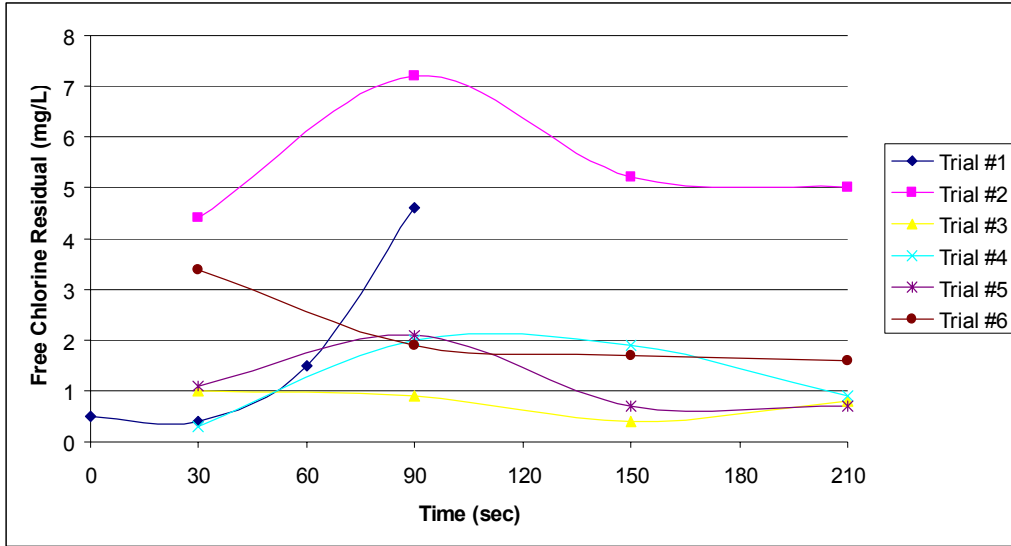

Figure 50: Chlorine Residual Concentrations With Modified DNA, Shown By Trial

Trials 1 & 2 contain all of the highest values. The subsequent four trials all gave free chlorine concentrations within the CDC specified range. This suggests the Pulsar system may experience slightly elevated levels during startup but would level out over time.

6.0 Discussion of Results

The previous success of the Pulsar 1 unit in Mali (see Section 1.3.4.1) laid the foundation for future work. The Mali study:

- Lasted 3 days;
- Ran at a constant 9.6 m³/hr (42.3gpm);
- Showed how key water quality parameters (pH, turbidity, chlorine demand) affect the Pulsar's disinfection capabilities.

This paper advances the knowledge base on all three of these topics. Water quality data was taken for a longer duration (two weeks in Ghana), at two lower flow rates than in Mali, and at both testing locations (Ghana & Cambridge, MA).

The results of the Ghana research demonstrate the potential of the Pulsar 1 system to operate at lower flow rates, and Section 3.2.7 describes the specific modifications which were undertaken. While previous work showed the unit's ability to function at approximately 42 gpm, this study provides data from Ghana and Cambridge, MA which shows promise of success at very low flow rates of 18 gpm and even 9 gpm, respectively.

6.1 Community-Scale Potentials

As previously discussed in Section 2.5, the necessary influent water quality parameters are turbidity <5 NTU and a pH <8 in order to ensure the chlorine disinfection mechanisms are effective. For many water sources (especially those originating from surface water), this is only achievable in conjunction with other treatment processes.

As with other community water projects, there are some indicators and metrics which can be used to evaluate the likelihood of success. Arch has identified the following three relevant parameters (Meyer 2004):

- Organization of a local water committee to oversee collection;
- Local involvement in construction and operation & maintenance;
- Locals accepting responsibility to pay their own water bills.

Water quality problems should also not be addressed in isolation from sanitation and hygiene improvements. Water quality is often interrelated with sanitation efforts since poor sewerage and wastewater practices can lead to large amounts of fecal sludge released into the environment (Vodounhessi and Munch 2006). Unfortunately conventional centralized sewerage collection and treatment is often not affordable to many households in developing countries without massive outside subsidies (government, donor, etc) (Whittington et al. 1993).

Proper hygiene education is also an important factor of success. One Ghanaian study found a link between maternal education and childhood diarrhea rates (Gyimah 2003). By analyzing the 1998 Ghana demographic data, the paper shows the probability of

childhood diarrhea is almost 30% lower (47% versus 76%) for a household with a “highly educated” versus “low educated” mother. The author explains the results by suggesting that educated women are more regularly exposed to the importance of hygiene and nutrition in school, and as a result are more aware of disease causation and likely to engage in good sanitary practices.

6.2 Challenges to Implementation of Pulsar 1

6.2.1 Operational Challenges

The lessons learned while on-site in Ghana combined with the insights gained from the application of other chlorine dosing technologies suggests there are several challenges which must be overcome for the Pulsar 1 system to be successful. Below is a list of possible hurdles:

- Necessary training required to install and maintain Pulsar 1 system
Compared to other household water treatment options (such as the *Kosim* filter with Aquatabs), the Pulsar unit is difficult to install. It requires plumbing materials and knowledge, as well as general familiarity with water flow characteristics. For instance, it would be difficult to explain its operation without using terms like pressure head, venturi, and suction flow. Such complexity could be prohibitive in certain situations (both rural and urban) which demand simplicity such as those experienced by the author during January 2008 in Ghana.
- Availability of dry HTH chlorine
The Pulsar 1 unit requires HTH tablets to run. One characteristic which makes distributed access easier is that local production of HTH is unnecessary and likely impractical. Therefore, a site which cannot expect dependable delivery is not well-suited. HTH also has a recommended shelf life of 1-2 years (Meyer 2004). Proper storage might therefore make it possible to keep a future stock but it must be understood that the available chlorine percentage will slowly degrade over time and the HTH must be stored within the appropriate conditions.
- Water quality data requirements
The system requires regular, systematic, and dependable water quality data collection and maintenance over time for a minimum of 3 key parameters (turbidity & pH of influent water, and free chlorine residual of effluent). Once the system has been configured and is unaltered, the output chlorine concentrations will likely remain fairly constant until the water quality (i.e. chlorine demand) changes. In some cases this could be predictable, as is the case for the first rain of the year. For other unpredictable situations, it might be difficult to anticipate chlorine residual changes. To ensure continued water quality, a program which monitors free chlorine residual, pH, and turbidity (at a minimal) should be created.

- Difficulty of predicting chlorine output residual concentrations
Inevitably the incoming water quality will change, either predictably or unpredictably. Assuming proper training, it is easy to know the appropriate type of alteration, but very difficult to know *how much* of a change to make. At this time, there is no data, equation, or methodology which lays out how to precisely set the system controls to achieve desired free chlorine residuals. Thus, proper operation and maintenance of the Pulsar 1 system would require a certain level of technical capacity. This capacity could be available in Northern Ghana, but it would require specific training and follow up.

6.2.2 Maintenance Challenges

While the Pulsar unit is fairly sturdy, it does contain many parts which could possibly break. The operations manual lists 29 parts total, with the only routine maintenance issue resulting from calcium carbonate buildup (Arch Chemicals 2003a). Recommended service includes a simple washing of the tablet grid with a dilute acid solution or scraping with a putty knife.

Over the course of the research, two internal fittings were delivered broken for the unit in Cambridge, MA, and the Ghana unit suffered a cracked outer shell while in shipment. Thankfully the latter damage was only aesthetic; otherwise the on-site Ghana research might have been severely limited. The inner fittings required replacement, which could have resulted in a prolonged shutdown if it occurred in a rural area of Northern Ghana.

6.2.3 Potential Hazards with Handling and Use of Calcium Hypochlorite

An issue of concern is the effect of weather on the Pulsar and HTH. The Material Safety Data Sheet (MSDS) for HTH calcium hypochlorite lists the maximum recommended storage temperature to be 125 degrees Fahrenheit (~52 degrees Celsius) (Arch Chemicals 2001). Parts of Ghana can experience weather of this magnitude, which could result in rapid decomposition of the HTH. Above this temperature the product can combust, and as such both the Pulsar unit and the HTH briquettes should be kept out of the sun at all times. No such problems were experienced in the course of this research because the temperature never rose above ~105 degrees Fahrenheit in the month of January 2008. Moreover, the product should not come into contact with certain other materials (see the MSDS in Section 10.5 for further information).

6.2.4 Sensitivity to Input Parameters

As discussed before, the Pulsar unit is sensitive to its input parameters. Should turbidity rise above 5 NTU or the pH above 8, chlorine disinfection efficacy will drop off precipitously. The author's work was conducted in the middle of the dry season and thus

experienced no rain during the three weeks of field research. Further studies need to be done to observe the effects of the natural water variation across both the dry and rainy seasons.

The most important system parameter is likely the flow rate. Even with all other water quality parameters remaining constant, the flow rate will drastically alter the operation of the Pulsar 1. For instance, as the flow rate increases, the height of water in the dissolving cup will rise, leading to more contact with the HTH and thus a higher chlorine concentration output. Unfortunately this increased chlorine dosage is not necessarily the proper amount to keep the overall chlorine output in equilibrium. Thus each separate flow rate has to be tested with one or more of the modifications listed in Section 3.2.7.1 in order to remain within the correct free chlorine residual target range.

6.3 Study Limitations

Though the research built upon many of the intended topics listed in Section 1.0, certain limitations were experienced. For instance, influent water quality remained consistent over the course of the study. Since the source is a water treatment plant with a surface water intake on the Volta River, the possibility remains that quality might only mildly fluctuate over time. However, assuming consistent influent parameters over time in other circumstances is likely to be unrealistic.

Another shortcoming of the study is that the alterations made in the Cambridge, MA lab have not been tested in Ghana. While the results look promising in the lab, unexpected complications can always occur when introduced into different real world situations.

A final limitation of the results was that the testing duration was too short to experience any serious maintenance issue or breakdown. Similar to the study done in Mali, no discernible system failure was observed. Although the Pulsar 1 operated successfully in both cases, it remains unknown what, if any, additional problems might occur over time in challenging conditions like those in Ghana.

7.0 Comparison of Pulsar 1 Unit to Aquatabs for Chlorination in Ghana

Comparing these two chlorination technologies is not entirely straightforward, partially because they are used at different scales, Aquatabs for household scale and Pulsar for a community scale. Nevertheless, there are certain evaluation metrics available which allow comparisons to be made.

7.1 Cost of HTH and Aquatabs

One of the most important drivers for any technology, especially in a developing country, is cost. Comparing the costs of Aquatabs for use together with the *Kosim* ceramic pot filter and HTH for the Pulsar 1 system is relatively straightforward. Section 1.3.4.1 discusses how the HTH retail cost was estimated to be \$0.032/m³. The retail cost of Aquatabs in Ghana is assumed to be \$0.03 per tablet (Murcott 2007a), or roughly \$1.5/m³.

Figure 51 shows how these two chlorine technologies based solely on the supplies cost compare to other drinking water options in Ghana.

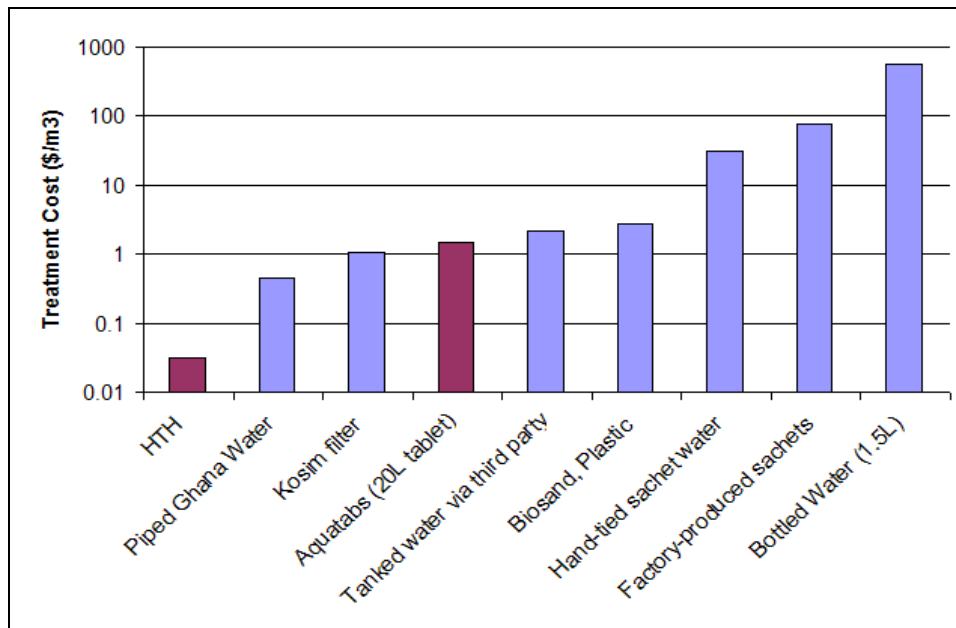

Figure 51: Cost of HTH & Aquatabs Compared to Other Drinking Water Options (Murcott 2007c)

While both chlorination methods are relatively cheap, HTH is clearly more cost effective at \$0.032/m³ (approximately 48 times cheaper than Aquatabs). This is expected since it treats a much larger amount of water, which provides an economy of scale. The Pulsar system remains cheaper (on a net present value \$/m³ basis) even when the analysis is expanded to include the capital cost of the unit and its potential labor costs. Figure 52 below shows the total costs of treatment.

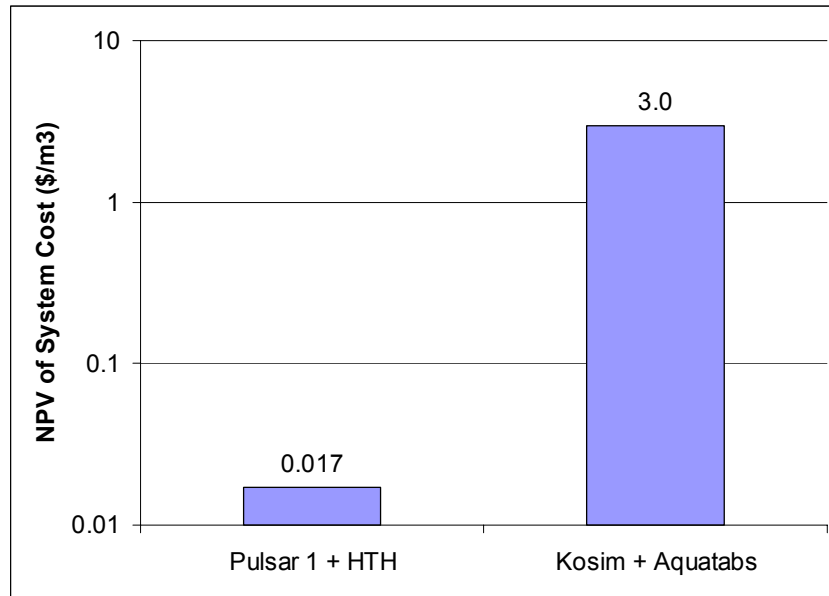

Figure 52: Net Present Value (NPV) Comparison of Pulsar 1 + HTH versus *Kosim* + Aquatabs, Normalized to Treatment Cost per Volume

The results show that total treatment costs of these systems in net present value terms are substantially different, with the Pulsar 1 + HTH option approximately 170 times cheaper than the *Kosim* + Aquatabs treatment (0.017 \$/m³ versus 3.0 \$/m³, respectively). Although some of the input assumptions are subjective, the overall result of the Pulsar 1 + HTH option being much cheaper is likely to remain true under any reasonable set of assumptions. See Section 10.2 in the appendices for a list of the author's assumptions and calculations.

7.2 Comparison of Water Disinfection Efficacy

Since both Aquatabs and HTH utilize similar chlorination chemistry, one would expect their disinfection efficacy to also be similar. As discussed in Chapter 1, the Aquatabs investigations were conducted by another researcher. While the author focused the HTH research mostly on free chlorine residual measurements, the Aquatabs work also included Total Coliform (TC) and Escherichia Coli (EC) counts (Swanton 2008).

7.3 Consumer Preference

7.3.1 Effect of Chlorine Taste on Consumer Preference

Consumer acceptance for the chlorine taste and odor was also studied. In some countries, the appropriate chlorine dose takes into account the local taste preferences. For example, research conducted in Nepal considered as much as a 50% reduction in chlorine dose in

order to increase user acceptance because the Nepalese didn't seem to like the taste of chlorinated water (CDC 2005a).

Survey results conducted in January 2008 suggest that chlorine taste in Ghana has some positive associations with treated, and therefore safe, water (Green 2008). In fact, respondents in urban settings actually had a slight preference for chlorine because of the “clean taste”. Rural consumers were found to not have any preference relative to chlorine taste.

A more comprehensive discussion of the consumer choice research, methodology, and results may be found in the other MIT researcher's thesis (Green 2008).

7.4 General Sustainability Comparison















The final and most difficult metric on which to evaluate these two products is their sustainability. The previous chapter covers many of the potentials and challenges of operating and maintaining the Pulsar unit, but further discussion of how this compares to the *Kosim* filter with Aquatabs is warranted.

The following operational challenges were identified in Chapter 5 for the Pulsar system:

- Necessary training required to install and maintain Pulsar 1 system
- Availability of dry HTH chlorine
- The system requires systematic and dependable water quality data
- Difficulty of predicting chlorine output residual concentrations

A good way to appraise their relative sustainability is to compare the Pulsar's challenges to those of Aquatabs. In order to get a better understanding of the relevant differences between these products, a multi-objective analysis table is given below. Note that many of these items are qualitative and reflect the best, but nonetheless, subjective opinion of the author. Also, the values for each category are meant to be relative, not absolute. If these systems were compared to others the values could be different.

Table 13: General Sustainability Comparison of Chlorination Systems

	<i>Kosim</i> Filter with Aquatabs	Pulsar 1 Unit with HTH
Maximum Flow Rate	Low (1-7 L/day)	High (>100,000 L/day)
Can Serve Many People		
Cost of Treatment (\$/m³)		
System Lifetime	~2 years*	~10 years*
Low Initial Cost (\$)		
Low Running Cost (\$/yr)		
Simple O&M		
Materials Availability		
*Value Assumed by Author  =Poor  = Moderate  =Good		

This table highlights many of the tradeoffs between the critical issues when choosing one system over another. There is clearly no “single best option”, which means site-specific circumstances should dictate the appropriate technology.

While both options were purposefully designed to be as simple as possible, the Pulsar unit is certainly more complex. It’s difficult to imagine a more simplistic method for water disinfection than the *Kosim* with Aquatabs option, but there is no such thing as a foolproof system. Installing and maintaining a Pulsar unit would likely require a trained operator to be on-site or nearby to be able to provide necessary adjustments or maintenance. The use of Aquatabs does not necessitate this requirement.

One unknown for both systems is the unit’s life under Ghanaian conditions. High levels of turbidity, extreme weather (dust and heat), and the potential for lack of proper maintenance are all factors which will likely shorten the lifespan of any water treatment system.

The other operational challenges identified above for the Pulsar unit are applicable to Aquatabs as well. Both systems are dependent on a steady and dependable supply of an imported chlorine source (HTH or Aquatabs). Both systems require consistent and reliable water quality data to ensure proper treatment doses, although this is probably less critical for Aquatabs. If water is perceived as too turbid, then the recommended dosage becomes two tablets instead of one.

Data collected in January 2008 suggests that Aquatabs do not currently provide any better way of predicting chlorine residuals than the Pulsar unit. While both are susceptible to changes in influent parameters, differences in storage also needs to be considered with the Aquatabs option. Figure 53 illustrates just how dramatic these variations can be.

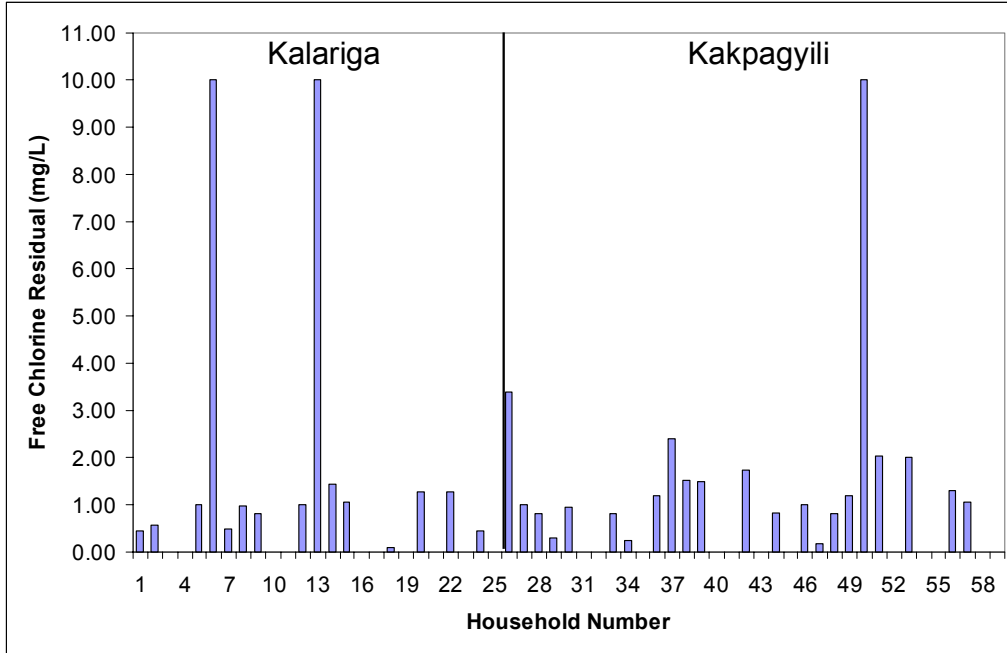

Figure 53: Aquatabs Variability of Free Chlorine Residual in Ghana (Swanton 2008)

The influent water for each village is coming from the same dugout, yet this graphic shows that chlorine residual levels ranged anywhere from 0 mg/L to >10 mg/L. What remains unknown and requires further research is if these variations are a result of dosing practices, duration of dosage to time of measurement, or differences in certain storage practices.

8.0 Conclusions & Recommendations

The Pulsar 1 system (using high-test hypochlorite as a chlorine source in conjunction with other modifications) shows potential of being a successful community scale water disinfection system in developing country applications such as Northern Ghana. While previous research showed the system could operate at flow rates approximating 42 gpm, this research focused on lower flow (18 and 9 gpm) scenarios. The following key findings support these conclusions:

- Field testing in Ghana indicated that most (3 out of 4) data points had free chlorine residual concentrations in the range of 10 - 14 mg/L while running at full dilution with modified parts. By additionally altering the Pulsar's inlet flow rate, these values were successfully reduced to the CDC specified guidelines of less than 2.0 mg/L in all cases (10 out of 10).
- Laboratory results in the MIT lab in Cambridge showed most (17 out of 24) of the free chlorine residual data was equal to or less than 2.0 mg/L at a very low flow rate (9 gpm).
- There was no system breakdown during the three weeks of field testing in Ghana or during subsequent research in Cambridge.

8.1 Future Research

There are several areas which still need to be better understood before implementation of the Pulsar 1 system should be considered in Ghana or other similarly challenging developing country contexts, and further research should be conducted in Northern Ghana and at other sites to ensure similar results.

Probably the most important issue is to create a model which predicts how altering various input parameters will affect the free chlorine residual concentration. Having such a model would allow the quick prediction of necessary chlorine, treatment costs, and even future potential challenges. The specific input parameters to be considered should, at the least, include:

- System flow rate
The research conducted by the author was only able to observe the Pulsar 1 system treating relatively low flow rates in Ghana and Cambridge (approximately 18 gpm and 9 gpm, respectively). Other previous research also realized success at a higher flow rate of 42 gpm (Eau Lambda 2005). Ideally the system would be tested over a wider range of flows.
- Influent water quality (pH, turbidity, and temperature)
Other major water quality parameters can alter the efficacy of the chlorine disinfection process. While the conditions which require additional chlorine (a high pH or turbidity) are understood, a potential model to quantify these effects in the Pulsar system needs further study. For instance, there is currently no way to

accurately predict how much more HTH it takes to disinfect water with 5 NTU and a pH of 7.5 than a similar volume with 1 NTU and pH of 6.0 for the Pulsar 1 unit.

- Relevant Pulsar 1 system modifications such as a spiked grid, dilution nozzle assembly (DNA), and an emergency shutoff valve (ESV)

Additional research needs to be done to identify how these various modified parts (see Section 3.2.7) interact with each other and the other influent water parameters. Although the Pulsar 1 system's success in Ghana and Cambridge, MA was a direct result of these modifications, further work needs to be done in varied locations and conditions to better understand their behavior.

8.2 Pure Home Water

There are several steps which Pure Home Water (PHW) could take to aid in the promotion of the Pulsar 1 system in Ghana. Since a functional Pulsar 1 unit is now available in the Tamale area, sites (as outlined in Section 2.5) with greater flow rates should be considered for further research.

It will be difficult for this technology to be properly assessed in Ghana by a one year Master's of Engineering student because of the inherent short duration of research time available. Thus it would be helpful to either extend the stay of a researcher, or have a locally qualified individual to aid in the extensive data collection and laboratory work necessary to extend the understanding suggested in Section 8.1.

8.3 Arch Chemicals

Arch Chemicals support of the author's work is difficult to overstate. Even so, additional future assistance will likely be necessary to better adapt the Pulsar 1 system to drinking water conditions. To date, the three modified parts (spiked grid, emergency shutoff valve [ESV], and dilution nozzle assembly [DNA]) show potential for successful implementation of the Pulsar 1 unit at low flow rates. In the future, these modified parts may need to be installed prior to shipping to reduce the potential for installation error and ensuring product quality. Future collaboration between Arch Chemicals, MIT, and potentially other universities in Ghana such as The University for Development Studies, The University of Ghana, or the Kwame Nkrumah University of Science and Technology will be critical to ensure the successful progression of the Pulsar 1 unit into community-scale drinking water systems.

9.0 References

- About Inc. "Ghana." <<http://geography.about.com/library/cia/blcghana.htm>>.
- Ampomah, B. (2004). "Implementing Integrated Water Resource Management (IWRM) in Ghana - The Case of the Densu Basin Pilot Project".
- Arch Chemicals. (Accessed 2008). "CCH Dry Chlorinator for Treatment of: Potable Water" <http://www.archchemicals.com/Fed/ICM/Products/Industrial/ProdLit/17-34ad_potable.pdf?site=ICM&lang=en&cat=Products&subcat=Industrial%20Water%20Products&override=&previd=>>.
- Arch Chemicals. (2003a). "Pulsar 1 Operator's Manual". Arch Chemicals. Cheshire, CT.
- Arch Chemicals. (2003b). "Arch Chemicals Supplies Calcium Hypochlorite to U.S. Department of Defense and to UNICEF for Sanitizing Drinking Water in Iraq". Accessed April 2008)
<http://www.archchemicals.com/Fed/Corporate/News/Articles/May7_2003.htm?cat=News%20Center&lang=en&override=&previd=&site=Corporate&subcat=NONE>
- Arch Chemicals. (2001). "Material Data Safety Sheet (MSDS) for Calcium Hypochlorite, Granular". Arch Chemicals. Cheshire, CT.
- Arch Chemicals. (2000). "HTH Dry Chlorinator for Use in: Municipal Water & Wastewater".
- Berens, J., and Van Dusen, E. (2007). "Chlorine Dispenser Project". Unpublished Document.
- Blanchette, D. (2007a). "0.25 Inch Spikes Feed Rate". Unpublished Laboratory Data. Arch Chemicals. Cheshire, CT.
- Blanchette, D. (2007b). "Pulsar 1 Operation in the Field". Unpublished Data. Arch Chemicals. Cheshire, CT.
- Blanchette, D. (2006). "Arch Chemicals - Water Chlorination Feed Equipment Technology". Powerpoint Presentation – Oct 23, 2006.
- Blanton, L. "The Health Impact Study of Aquatabs in Tamale". Performed in Northern Ghana during November 2006. Preliminary Report.
- British Broadcasting Company (BBC).
<http://www.bbc.co.uk/weather/world/city_guides/results.shtml?tt=TT000250>.
Accessed Dec 2007.
- Brown, J. (2007). "Effectiveness of Ceramic Filtration for Drinking Water Treatment in Cambodia." Post Doctoral Degree Thesis, Department of Environmental Sciences and Engineering, University of North Carolina, Chapel Hill.

- Brown, J., and Sobsey, M. (2007). "Improving Household Drinking Water Quality: Use of Ceramic Water Filters in Cambodia".
<http://www.wsp.org/filez/pubs/926200724252_eap_cambodia_filter.pdf>
- Cairncross, S., and Feachem, R. (1983). *Environmental Health Engineering in the Tropics: An Introductory Text*. John Wiley & Sons, 1983.
- Center for Disease Control (CDC). (2008). "Chlorine Residual Testing Fact Sheet"
<http://www.cdc.gov/safewater/publications_pages/chlorineresidual.pdf>.
- Center for Disease Control (CDC). (2005a). "Chlorine Dosing Report: Kathmandu Valley, Nepal, Janakpur, Nepal, and Biratnagar and Surrounding Areas, Nepal".
- Center for Disease Control (CDC). (2005b). "Chlorine Residual Testing"
<http://www.cdc.gov/safewater/publications_pages/chlorineresidual.pdf>.
- Center for Disease Control (CDC). (2004). "Strength and Quantity of Hypochlorite Solutions: How Much Is Enough?".
<<http://www.cdc.gov/ncidod/diseases/hanta/hps/noframes/bleach.htm>>
- Central American Research Institute of Industrial Technology (ICAITI). (1984). "Identification and Evaluation of Design Alternatives for a Low Cost Domestic Filter for Drinking Water".
- CIA. <<https://www.cia.gov/library/publications/the-world-factbook/rankorder/2091rank.html>>. Accessed Mar 2008.
- CIA. "World Factbook." <<http://www.indexmundi.com/g/r.aspx?c=gh&v=30>>. Accessed Dec 2007.
- Da Vinci, L., and Medentech Ltd. (2006). "Aquatabs: Water is the Driving Force of Nature".
- Donachy, B. (2004). "Manual/Guide for Health Trainers and Others Involved in the Monitoring of the Colloidal Silver Ceramic Water Filter".
- Earth Trends. (2003). "Economic Indicators - Ghana".
- Eau Lambda, Porque, B. (2005). "Water Supplies in Mali - Disinfection of Water in a Rural Environment". Unpublished Report.
- Food and Agriculture Organization of the United Nations (FAO). (Accessed Dec 2007). "Special Programme for Food Security" <www.fao.org/SPFS/ghana_en.asp>.
- Foran, M. (2007). "An Analysis of the Time to Disinfection and the Source Water and Environmental Challenges to Implementing a Solar Disinfection Technology (SolAgua)." Master's Thesis, Harvard School of Public Health, Boston, MA.

Ghana Statistical Service (GSS), Noguchi Memorial Institute for Medical Research (NMIMR), and ORC Macro. (2004). "Ghana Demographic and Health Survey 2003".

Globe Media Limited. (2007). "Map of Ghana."
<<http://www.wordtravels.com/Travelguide/Countries/Ghana/Map>>.

Green, V. (2008). "Consumer Choice of Household Water Treatment and Safe Storage Product in Northern Region, Ghana." Master's of Engineering Thesis, Massachusetts Institute of Technology, Civil and Environmental Engineering Department, Cambridge, MA.

Gyimah, S. (2003). "Interaction Effects of Maternal Education and Household Facilities on Childhood Diarrhea in Sub-Saharan Africa: The Case of Ghana." *Journal of Health and Population in Developing Countries*. Online peer reviewed publication from the School of Public Health, University of North Carolina.
<http://www.jhpdc.unc.edu/2003_papers/gyimah.pdf>.

Hach. "Chlorine (Free & Total), Pocket Colorimeter II Test Kit." <http://www.hach.com/>
Accessed March 2008.

Harp, D. (1995). "Current Technology of Chlorine Analysis for Water and Wastewater". Technical Information Series – Booklet No. 17." *Hach Company*.

Hua, F., West, J., Barker, R., and Forster, C. (1998). "Modeling of Chlorine Decay in Municipal Water Supplies." PhD thesis, University of Birmingham, UK.

Hwang, R. (2003). "Six-Month Field Monitoring of Point-Of-Use Ceramic Water Filter by Using H₂S paper Strip Most Probable Number Method in San Francisco Libre, Nicaragua." Master's of Engineering Thesis, Massachusetts Institute of Technology, Civil and Environmental Engineering Department, Cambridge, MA.

International Committee of the Red Cross. (2002). "Kit, Water Treatment, Sanikit"
<<http://www.redcross.int/en/eric/eric/screen%20tome%201/09WATscreen/393KWTEDO SI03.pdf>>.

International Monetary Fund (IMF). <www.imf.com>. Accessed Dec 2009.

Jackson, M., and Murcott, S. (May 2008). "Kosim Ceramic Pot Filter - Household Water Treatment and Safe Storage (HWTS) Pure Home Water – Product Technical Specification Sheet".

Johnson, S. (2007). "Health and Water Quality Monitoring of Pure Home Water's Ceramic Filter Dissemination in the Northern Region of Ghana." Master's of Engineering Thesis, Massachusetts Institute of Technology, Civil and Environmental Engineering Department, Cambridge, MA.

M20 Manual of Water Supply Practices. (2006). *Water Chlorination/Chloramination Practices and Principles*. American Water Works Association, 2006.

Medentech Ltd. (2007a). "Contribution to the Millennium Development Goals & Ghana". Wexford, Ireland.

Medentech Ltd. "Products - Aquatabs." Wexford, Ireland.
<http://www.medentech.com/product_info.cfm?ID=1>. Accessed Mar 2008.

Medentech Ltd. (2006). "Aquatabs: Technical Report". Wexford, Ireland.

Medentech Ltd. (2001). "Materials Data Safety Sheet (MSDS) - Aquatabs 67 mg". Wexford, Ireland.

Medical Assistance Programs (MAP) International. (1985). "Final Report on the Water Filter Project. No. 518-0015-G-3049-00 and No.518-0015-G-00-4073-01 & 02".

Metcalf & Eddy. (2003). *Wastewater Engineering, 4th Edition*. New York. McGraw-Hill Science/Engineering/Math.

Meyer, E. "Use of Dry Chlorine for Low Tech Sanitation: Case Studies in Developing Regions". Powerpoint Presentation on June 22, 2004. Arch Chemicals, Cheshire, CT.

MIT. "Chlorine Disinfection Technologies." http://mit.edu/watsan/chlorine_tech.htm (April 2008).

Murcott, S. (2007a). "Aquatabs: Household Water Treatment and Safe Storage (HWTS) Product and Implementation Fact Sheet".

Murcott, S. (2007b). "Draft Request for Proposal: Household or Community-Scale Water Treatment for Low-Income Communities in Northern Ghana".

Murcott, S. (2007c). "Situation Report on Viable Household Water Treatment and Safe Storage Options in Ghana and Factors Supporting Their Dissemination and Scale-up: July 2007 Report to PATH's Safe Water Project".

Okioga, T. (2007). "Water Quality and Business Aspects of Sachet-Vended Water in Tamale, Ghana." Master's of Engineering Thesis, Massachusetts Institute of Technology, Civil and Environmental Engineering Department, Cambridge, MA.

J. Parr, Smith, M. and Shaw, R. "46. Chlorination." <<http://www.lboro.ac.uk/well/resources/technical-briefs/46-chlorination.pdf>> Accessed December 2007.

Peletz, R. (2006). "Cross-Sectional Epidemiological Study on Water and Sanitation Practices in the Northern Region of Ghana." Master's of Engineering Thesis, Massachusetts Institute of Technology, Civil and Environmental Engineering Department, Cambridge, MA.

R. Rivera. Ceramic Weapons of Mass Bacterial Destruction: Produced Locally to Help Make Water Potable at the Household Level, Worldwide.”

<<http://www.changemakers.net/en-us/node/5662>>. Accessed 2008.

Skinner, B. (2001). "Chlorinating Small Water Supplies: A Review of Gravity-Powered and Water-Powered Chlorinators." PhD thesis, Leicestershire.

Smith, A. (2008). "Lecture Given at MIT 2.500 Desalination class". Massachusetts Institute of Technology, Cambridge, MA.

Swanton, A. (2008). "Evaluation of the Complementary Use of the Ceramic (Kosim) Filter and Aquatabs in Northern Region, Ghana." Master's of Engineering Thesis, Massachusetts Institute of Technology, Civil and Environmental Engineering Department, Cambridge, MA.

Tew, L. (2008). "Cost of HTH in Ghana". Personal Email Communication.

Tew, L. (2006). "Use of Dry Chlorine for Low Tech Drinking Water Sanitation". Powerpoint Presentation by Arch Chemicals.

Trevalinet, B. (October 23, 2006). "Water For People, Water For Life in Africa". Powerpoint Presentation by Arch Chemicals. Cheshire, CT.

United Nations (UN). "UN Millennium Development Goals"
<<http://www.un.org/millenniumgoals/>>. Accessed Dec 2007.

United Nations Children's Fund (UNICEF). "Ghana Statistics."
<http://www.unicef.org/infobycountry/ghana_statistics.html>. Accessed Dec 2007.

United Nations Department of Economic and Social Affairs (UN-DESA). (2006). "The Millenium Development Goals Report"
<<http://mdgs.un.org/unsd/mdg/Resources/Static/Products/Progress2006/MDGReport2006.pdf>>.

United Nations Non-Governmental Liaison Service (UN-NGLS). "Questions & Answers." <<http://www.un-ngls.org/MDG/Q&A.htm>>. Accessed 2007.

United States Aid for International Development (USAID). (2001). "*USAID Nicaragua Supplemental Reconstruction Programs: Response to Hurricane Mitch, October 1998. Status as of June 30, 2001*" <http://hurricane.info.usaid.gov/qhr_nic_jun01.doc>.

USEPA. (2005). "National Primary Drinking Water Regulations: List of Drinking Water Contaminants and MCLS." <<http://www.epa.gov/ogwdw/mcl.html>>.

USEPA. (1997). "Summary of New Health Effects Data on Drinking Water Disinfectants and Disinfectant Byproducts (D/DBP) for the Notice of Data Availability (NODA)".

Vodounhessi, A., and Munch, E. (2006). "Financial Challenges to Making Faecal Sludge Management an Integrated Part of the Ecosan Approach: Case Study of Kumasi, Ghana".

Water for the World. (2007). "Designing a Small Community Disinfection Unit" <<http://www.lifewater.org/resources/rws3/rws3d4.pdf>>.

Whittington, D., Lauria, D., Wright, A., Choe, K., Hughes, J., and Swarna, V. (1993). "Household Demand for Improved Sanitation in Kumasi, Ghana: A Contingent Valuation Study." *Water Resources Research*, (6).

WHO/UNICEF. "Joint Monitoring Programme (JMP) for Water Supply and Sanitation." <<http://www.wssinfo.org/en/welcome.html>> Accessed Dec 2007.

World Health Organization (WHO). (2007). "WHO Guidelines for Drinking-Water Quality: Draft Chapter on Rainwater Harvesting" <http://www.who.int/water_sanitation_health/gdwqrevision/rainwater.pdf>.

World Health Organization (WHO). (2006). "Guidelines for Drinking-Water Quality, 3rd Edition, Incorporating First Addendum. Volume 1 - Recommendations".

World Health Organization (WHO). (2004). "Water Treatment and Pathogen Control" <http://www.who.int/water_sanitation_health/dwq/en/watreatpath.pdf>.

World Health Organization (WHO). (2003). "Iodine in Drinking-Water" <http://www.who.int/water_sanitation_health/dwq/chemicals/iodine.pdf>.

World Health Organization (WHO). (1997). *Guidelines for Drinking-Water Quality, Volume 3: Surveillance and Control of Community Supplies*. 1997.

World Health Organization (WHO). (1993). *Guidelines for Drinking-Water Quality*. 1993.

Yamana, T., and Nepf, H. (2003). "Further Investigation of the CTI8 Chlorinator: Undergraduate Research Opportunity Program (UROP) Final Report". Massachusetts Institute of Technology, Civil and Environmental Engineering Department, Cambridge, MA.

Yazdani, I. (2007). "High Density Polyethylene (HDPE) Containers as an Alternative to Polyethylene Terephthalate (PET) Bottles for Solar Disinfection of Drinking Water in Northern Region, Ghana." Master's of Engineering Thesis, Massachusetts Institute of Technology, Civil and Environmental Engineering Department, Cambridge, MA.

10.0 Appendices

10.1 Relevant Conversion Tables for English & Metric

To Convert	Into	Multiply By
Atmosphere	Feet of head	33.9
Centigrade	Fahrenheit	$(C \times 9/5) - 32$
Centimeter	Feet	3.28E-02
Centimeter	Inches	3.94E-01
Feet	Centimeters	3.05E+01
Feet	Meters	0.3048
Gallons	Liters	3.78
GPM	m ³ /hr	0.227
Inches	Centimeters	2.54
Kilograms	Pounds	2.205
Liters	Gallons	0.26
m ³ /hr	GPM	4.41
Meters	Feet	3.281
Meters	Inches	39.37
Pounds	Kilograms	0.4536

10.2 Calculation of Net Present Value (NPV) Comparison for Pulsar 1 with HTH versus *Kosim* filter with Aquatabs

Market Assumptions		NOTES
Discount rate (%)	10	
Pulsar Assumptions		
Amount of water Pulsar treats per year (m3)	109500	(300 m3/day)*(365 days/year)
Pulsar unit lifetime (yr)	10	
Pulsar 1 unit cost in Ghana (\$)	500	
HTH in Ghana (\$/yr)	3.45	(0.0000315 \$/m3)*(300 m3/day)*(365 day/yr)
Labor for Pulsar System (\$/yr)	3000	(250 \$/month)*(12 months/yr)
Kosim Assumptions		
Amount of water Kosim treats per day (L)	18	(1.5 L/hr)*(12 hrs/day)
Amount of water Kosim treats per year (m3)	6.57	(18 L/day)*(365 days/yr)/(1000 L/m3)
<i>Kosim</i> unit cost in Ghana (\$)	15	
<i>Kosim</i> unit lifetime (yr)	2	
Aquatabs Cost (\$/yr)	9.855	(1.5 \$/m3)*(1 m3/1000 L)*(18 L/day)*(365 days/yr)
NPV Calculation		
	Pulsar 1 + HTH	<i>Kosim</i> + Aquatabs
NPV (\$)	18,955	39.5
NPV (\$/m3)	0.017	3.0

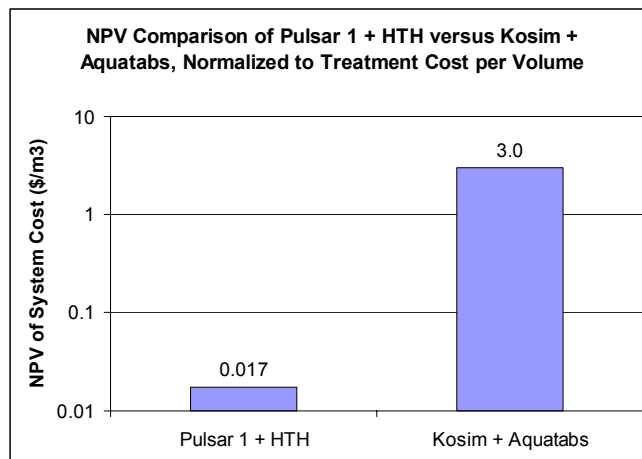

10.3 Data Taken in Ghana

Source Water Quality Parameters in Ghana
Used in Section 3.2.3

Water Sample from faucet in Peace Corps kitchen		
Parameter	Testing Method	Result
Turbidity	Turbidity Tube	<5 NTU
Test Strips	Free Chlorine	0 mg/L
Test Strips	Total Chlorine	0 mg/L
Digital Titrator	Total Chlorine	0 mg/L
Test Strips	pH	6
Water Sample from Candle Filter: British Berkfeld at Peace Corps Office		
Method	Test	Result
Test Strips	Free Chlorine	0
Test Strips	Total Chlorine	0
Test Strips	pH	7

Determining Chlorine Demand of Ghanaian Water
Used in Section 3.2.4

*Solution was prepared with 0.1mL of 3.5% bleach with 700mL bottled Voltic or tap water, expected chlorine solution is therefore 5.5ppm

Source	Type	Test	Result (ppm)	Chlorine Demand (ppm)
Bottled Voltic Water	Titration	Free	2.3	3.2
Bottled Voltic Water	Titration	Total	2.8	2.7
Bottled Voltic Water	Titration	Total (REPEAT)	2.8	2.7
		Combined		
Bottled Voltic Water	Titration	(calculated)	0.5	
Tap Water	Titration	Free	3.5	2
Tap Water	Titration	Total	3.9	1.6
Tap Water	Titration	Free (REPEAT)	3.3	2.2
Tap Water	Titration	Total (REPEAT)	3.5	2
Tap Water	Strips	Free	4	
Tap Water	Strips	Total	6	
Tap Water	Strips	Free (REPEAT)	4	
Tap Water	Strips	Total (REPEAT)	6	

Determining Gravity Outflow from Elevated Tank into Pulsar (Ghana System)
Used in Section 4.1

Datum is lip at top of tank, total depth to bottom is 47.75"					
Internal Diameter = 40.5 inches					
Trial	Time	Time (min)	Depth to water (inches)	Volume difference (ft ³)	Flowrate (gpm)
	0 min	0.00	47.75		
1	2 min	2.00	41.25	4.84	18.1
2	2 min, 38 sec	2.63	39.25	1.49	17.6
3	4 min, 13 sec	4.22	34.00	3.91	18.5
Average				Average =	18.1

Comparison of DPD Titration and Colorimeter as Lab Testing Methods
Used in Section 2.6.2

Source	Test Method	Test	Result (ppm)
Kitchen Tap	Colorimeter	Free Chlorine Residual	3.0
Kitchen Tap	Colorimeter	Total Chlorine Residual	3.2
Kitchen Tap	Titration	Free	2.7
Kitchen Tap	Titration	Total	2.8

NOTE: Dilution nozzle assembly (DNA) fully on (100%); ¼” spiked grid installed.

Original sample size (mL)	Dilution (mL)	Type	Test	Result (ppm)	Undiluted result (ppm)
15	75	Test Strips	Total Chlorine	4	
15	75	Test Strips	Free Chlorine	2	
15	75	DPD Titration	Total Chlorine	4.1	24.6
15	75	DPD Titration	Free Chlorine	3.8	22.8
15	75	Colorimeter	Total Chlorine	4.2	25.2
15	75	Colorimeter	Free Chlorine	3.9	23.4

Determining Time Effect on Chlorine Residual (Ghana System)
Used in Section 4.2

Method	Test	Original sample size (mL)	Dilution (mL)	Time (hour)	Time (days)	Result (ppm)	Undiluted result (ppm)
Colorimeter	Free Chlorine	15	0	0	0.00	2.7	2.7
Colorimeter	Free Chlorine (RETEST)	15	0	0	0.00	2.6	2.6
Colorimeter	Free Chlorine	15	0	1	0.04	2.3	2.3
Colorimeter	Free Chlorine	15	0	2	0.08	2.3	2.3
Colorimeter	Free Chlorine	15	0	3	0.13	2.3	2.3
Colorimeter	Free Chlorine	15	0	4	0.17	2.1	2.1
Colorimeter	Free Chlorine	15	0	5	0.21	2.2	2.2
Colorimeter	Free Chlorine	15	0	6	0.25	2.2	2.2
Colorimeter	Free Chlorine	15	0	7	0.29	2.1	2.1
Colorimeter	Free Chlorine	15	0	8	0.33	2.1	2.1
Colorimeter	Free Chlorine	15	0	10.3	0.43	2.1	2.1
Colorimeter	Free Chlorine	15	0	14.25	0.59	2.1	2.1
Colorimeter	Free Chlorine	15	0	22	0.92	1.9	1.9
Colorimeter	Free Chlorine	15	0	29	1.21	1.8	1.8
Colorimeter	Free Chlorine	15	0	46	1.92	1.7	1.7
Colorimeter	Free Chlorine	15	0	101	4.21	1.1	1.1
Colorimeter	Free Chlorine	15	0	127	5.29	0.8	0.8
Colorimeter	Free Chlorine	15	0	172	7.17	0.7	0.7
Colorimeter	Free Chlorine	15	0	199	8.29	0.7	0.7

Method	Test	Original sample size (mL)	Dilution (mL)	Time (hour)	Time (days)	Result (ppm)	Undiluted result (ppm)
Colorimeter	Free Chlorine	15	75	0	0.00	6.6	39.6
Colorimeter	Free Chlorine	15	75	1	0.04	6.1	36.6
Colorimeter	Free Chlorine	15	75	2	0.08	6.1	36.6
Colorimeter	Free Chlorine	15	75	3	0.13	6.1	36.6
Colorimeter	Free Chlorine	15	75	4	0.17	5.8	34.8
Colorimeter	Free Chlorine	15	75	5	0.21	5.7	34.2
Colorimeter	Free Chlorine	15	75	6	0.25	5.4	32.4
Colorimeter	Free Chlorine	15	75	7	0.29	5.5	33
Colorimeter	Free Chlorine	15	75	9.75	0.41	5.2	31.2
Colorimeter	Free Chlorine	15	75	13.5	0.56	5.4	32.4
Colorimeter	Free Chlorine	15	75	21	0.88	5.4	32.4
Colorimeter	Free Chlorine	15	75	28	1.17	4.9	29.4
Colorimeter	Free Chlorine	15	75	45	1.88	4.8	28.8
Colorimeter	Free Chlorine	15	75	100	4.17	4.8	28.8
Colorimeter	Free Chlorine	15	75	126	5.25	3.7	22.2
Colorimeter	Free Chlorine	15	75	171	7.13	3.7	22.2
Colorimeter	Free Chlorine	15	75	200	8.33	3.7	22.2

Effect of Dilution Nozzle Assembly on Pulsar Free Chlorine Residual Output Concentration (Ghana System)

Used in Section 4.4

NOTE: All tests are free chlorine with the colorimeter method taken at the storage influent. 1/4" grid spikes were installed.

Dilution Assembly (% on)	Suction flow (gpm)	Original sample size (mL)	Dilution (mL)	Result (ppm)	Undiluted Result (ppm)
0%	0.78	15	75	4.4	26.4
100%	0.75	15	75	2.2	13.2
67%	0.73	15	75	3.2	19.2
33%	0.7	15	75	6	36
0%	0.78	15	75	4.4	26.4
33%	0.7	15	75	6.8	40.8
33%	0.7	15	75	6.5	39
0%	0.7	15	75	8.2	49.2
0%	0.7	10	75	5.3	45.05
0%	0.7	10	75	4.5	38.25
100%	0.68	15	75	5.2	31.2
100%	0.68	15	75	2.6	15.6
100%	0.68	15	75	2.6	15.6
100%	0.68	15	75	2.8	16.8
100%	0.68	15	75	2.7	16.2
100%		15	75	2.9	17.4
100%		15	75	1.3	7.8
100%		15	75	1.1	6.6

Effect of Sampling Time on Free Chlorine Residual Concentration (Ghana System)

NOTE: All tests are free chlorine with the colorimeter method taken at the storage influent.

Time (sec)	Dilution Assembly (% on)	Suction flow (gpm)	Original sample size (mL)	Dilution (mL)	Result (ppm)	Undiluted Result (ppm)
0	100	0.68	15	75	5.2	31.2
30	100	0.68	15	75	2.6	15.6
60	100	0.68	15	75	2.6	15.6
90	100	0.68	15	75	2.8	16.8

Ball Valve Dilution Effect on Free Chlorine Residual (Ghana System)
Used in Section 4.5

Ball Valve (% on)	Method	Inlet flow (gpm)	Original sample size (mL)	Dilution (mL)	Result (ppm)	Undiluted Result (ppm)
0	Titration	0	25	0	0.15	0.15
0	Titration	0	25	0	0.2	0.2
33	Colorimeter	0.55	15	30	2.1	6.3
33	Colorimeter	0.55	15	0	5.9	5.9
33	Colorimeter	0.55	10	0	3.1	3.1
33	Titration	0.55	25	0	2.8	2.8
67	Colorimeter	0.77	15	75	1	6
67	Titration	0.77	25	0	5	5
67	Colorimeter	0.77	10	0	2.6	2.6
67	Titration	0.77	25	0	3.2	3.2
100	Colorimeter	0.8	15	75	2.1	12.6
100	Colorimeter	0.8	15	75	0.8	4.8
100	Colorimeter	0.8	10	0	4.4	4.4
67	Colorimeter	0.75	15	15	4.8	9.6
67	Colorimeter	0.75	10	0	7.5	7.5
33	Colorimeter	0.74	15	15	4.8	9.6
33	Colorimeter	0.74	10	0	5.5	5.5
33	Colorimeter	0.63	15	15	3.7	7.4
33	Colorimeter	0.63	10	0	3.5	3.5
50	Colorimeter	0.7	15	30	1.8	5.4
50	Colorimeter	0.7	15	0	1.7	1.7
17	Colorimeter	0.16	10	0	1.1	1.1
17	Colorimeter	0.16	10	0	1.5	1.5
15	Colorimeter	0.13	10	0	0.41	0.41
15	Colorimeter	0.13	10	0	0.57	0.57
0	Colorimeter	0	10	0	0.3	0.3
0	Colorimeter	0	10	0	0.3	0.3
17	Colorimeter	0.16	10	0	0.3	0.3
17	Colorimeter	0.16	10	0	0.3	0.3
16	Colorimeter	0.14	10	0	1	1
16	Colorimeter	0.14	10	0	1.2	1.2
33	Colorimeter	0.66	15	15	8.7	17.4
33	Colorimeter	0.66	15	30	3.5	10.5
16	Colorimeter	0.14	10	0	1.3	1.3
16	Colorimeter	0.14	10	0	1.3	1.3
50	Colorimeter	0.67	15	30	5.1	15.3
50	Colorimeter	0.67	15	30	3.6	10.8
100	Colorimeter	0.74	15	45	3.3	13.2
100	Colorimeter	0.74	15	45	2.7	10.8

Appendices

10.4 Data Taken in Cambridge

Source Water Quality Parameters in Cambridge Lab
Used in Section 5.1

Water Sample from faucet in MIT Lab (1-079)		
Parameter	Testing Method	Result
Turbidity	Turbidity Tube	<5 NTU
Test Strips	Free Chlorine	0 mg/L
Test Strips	Total Chlorine	1.5 mg/L
Digital Titrator	Free Chlorine	0.05 mg/L
Digital Titrator	Total Chlorine	0.9 mg/L
Colorimeter	Free Chlorine	0.15 mg/L
Colorimeter	Total Chlorine	1.0 mg/L
Test Strips	pH	7

Determining Gravity Outflow from Elevated Tank into Pulsar (Cambridge System)
Used in Section 5.2

NOTE: Trials 1-3 were taken prior to installation of the Pulsar 1 system. The results turned out noticeably different and were thus determined to be misrepresentative.

Datum is lip at 8 feet above ground (marked on green plastic container), bottom is ~6' 3"					
Internal Diameter = 2 feet					
Trial	Time	Time (min)	Water Height (ft)	Volume difference (ft ³)	Flowrate (gpm)
4	0 min	0.00	8.00	0.00	
	2 min, 24 sec	2.40	7.00	3.14	9.8
5	0 min	0.00	8.00	0.00	
	1 min	1.00	7.50	1.57	11.7
	2 min	2.00	7.10	1.26	9.4
	3 min	3.00	6.70	1.26	9.4
6	0 min	0.00	8.00		
	1 min	1.00	7.55	1.41	10.6
	2 min	2.00	7.20	1.10	8.2
	3 min	3.00	6.75	1.41	10.6
				Average =	9.8
7	0 min	0.00	8.00		
	1 min	1.00	7.56	1.38	10.3
	2 min	2.00	7.20	1.13	8.5
	3 min	3.00	6.74	1.44	10.8
				Average =	9.9
8	0 min	0.00	8.00		
	1 min	1.00	7.57	1.35	10.1
	2 min	2.00	7.20	1.16	8.7
	3 min	3.00	6.73	1.48	11.0
				Average =	9.9
9	0 min	0.00	8.00		
	1 min	1.00	7.58	1.32	9.9
	2 min	2.00	7.20	1.19	8.9
	3 min	3.00	6.72	1.51	11.3
				Average =	10.0

Effect of Sampling Time on Free Chlorine Residual Concentration (Cambridge System)
Used in Section 5.3

NOTE: All tests are free chlorine with the colorimeter method taken at the storage influent. The dilution nozzle assembly (DNA) was always fully on (100%) and ¼” spiked grid was installed.

Trial	Time (sec)	Inlet Flow (gpm)	Suction flow (gpm)	Result (ppm)
1	0	1.2	1.4	0.5
	30	1.2	1.4	0.35
	60	1.2	1.3	1.5
	90	1.2	1.3	4.6
2	30			4.4
	90	1.2	1.35	7.2
	150	1.1	1.2	5.2
	210			5.0
3	30	1.2	1.25	1.0
	90	1.15	1.3	0.9
	150	1.1	1.18	0.4
	210	0.95	1.1	0.7
4	30	1.25	1.35	0.3
	90	1.2	1.3	2.0
	150	1.05	1.15	1.9
	210	0.9	1.1	0.9
5	30			1.1
	90			2.0
	150			0.7
	210			0.7
6	30			3.4
	90			2.0
	150			1.7
	210			1.6

10.5 High-Test Hypochlorite (HTH) Material Data Safety Sheet (MSDS)

		MATERIAL SAFETY DATA
Arch Chemicals, Inc.		
FOR ANY EMERGENCY, CALL 24 HOURS/7 DAYS:	1-800-654-6911	
FOR ALL TRANSPORTATION ACCIDENTS, CALL CHEMTREC®:	1-800-424-9300	
FOR ALL MSDS QUESTIONS & REQUESTS, CALL MSDS CONTROL:	1-800-511-MSDS	
PRODUCT NAME: PULSAR® PLUS DRY CHLORINATOR BRIQUETTES		
SECTION 1 PRODUCT AND COMPANY IDENTIFICATION		
REVISION DATE:	04-02-1999	SUPERCEDES: None
MSDS NO:	01534-0003 - 30045	
MANUFACTURER: Arch Chemicals, Inc. 501 Merritt 7 PO Box 5204 Norwalk, CT 06856-5204		
SYNONYMS: None CHEMICAL FAMILY: Hypochlorite FORMULA: Not Applicable/Mixture DESCRIPTION: Sanitizer and Oxidizer OSHA HAZARD CLASSIFICATION: Oxidizer, toxic by inhalation, corrosive, skin and eye hazard, lung toxin		
SECTION 2 COMPONENT DATA		
PRODUCT COMPOSITION		
CAS or CHEMICAL NAME: Calcium hypochlorite		
CAS NUMBER: 7778-54-3		
PERCENTAGE RANGE: 60-80%		
HAZARDOUS PER 29 CFR 1910.1200: Yes		
EXPOSURE STANDARDS: 3 mg/cubic meter (ceiling) as Chlorine: Internal Exposure Standard		
CAS or CHEMICAL NAME: Sodium chloride		
CAS NUMBER: 7647-14-5		
PERCENTAGE RANGE: 10-20%		
HAZARDOUS PER 29 CFR 1910.1200: No		
EXPOSURE STANDARDS: None Established		
CAS or CHEMICAL NAME: Calcium chlorate		
CAS NUMBER: 10137-74-3		
PERCENTAGE RANGE: 0-5%		
HAZARDOUS PER 29 CFR 1910.1200: Yes		
EXPOSURE STANDARDS: None Established		
CAS or CHEMICAL NAME: Calcium chloride		
CAS NUMBER: 10043-52-4		
PERCENTAGE RANGE: 0-5%		
HAZARDOUS PER 29 CFR 1910.1200: Yes		
EXPOSURE STANDARDS: None Established		
01534-0003- 30045 PULSAR® PLUS DRY CHLORINATOR BRIQUETTES		
		Page 1 of 10

CAS or CHEMICAL NAME: Calcium hydroxide
 CAS NUMBER: 1305-62-0
 PERCENTAGE RANGE: 0-4%
 HAZARDOUS PER 29 CFR 1910.1200: Yes
 EXPOSURE STANDARDS:

	OSHA (PEL)		ACGIH (TLV)	
	ppm	mg/cubic-meter	ppm	mg/cubic-meter
TWA	None			5
CEIL	None		None	
ST	None		None	

CAS or CHEMICAL NAME: Calcium carbonate
 CAS NUMBER: 471-34-1
 PERCENTAGE RANGE: 0-4%
 HAZARDOUS PER 29 CFR 1910.1200: Yes
 EXPOSURE STANDARDS:

	OSHA (PEL)		ACGIH (TLV)	
	ppm	mg/cubic-meter	ppm	mg/cubic-meter
TWA:		15 (Total dust)		10
		5 (Respirable fraction)		
CEILING:	None		None	
STEL:	None		None	

CAS or CHEMICAL NAME: 2-Phosphono-1,2,4-tricarboxylic acid, sodium salt
 CAS NUMBER: 40372-66-5
 PERCENTAGE RANGE: 0.2-0.8%
 HAZARDOUS PER 29 CFR 1910.1200: No
 EXPOSURE STANDARDS: None Established

CAS or CHEMICAL NAME: Water
 CAS NUMBER: 7732-18-5
 PERCENTAGE RANGE: 4-10%
 HAZARDOUS PER 29 CFR 1910.1200: No
 EXPOSURE STANDARDS: None Established

SECTION 3 PRECAUTIONS FOR SAFE HANDLING AND STORAGE

DO NOT TAKE INTERNALLY. AVOID INHALATION OF DUST AND FUMES. AVOID CONTACT WITH EYES, SKIN OR CLOTHING. UPON CONTACT WITH SKIN OR EYES, WASH OFF WITH WATER. REMOVE AND WASH CONTAMINATED CLOTHING BEFORE REUSE.

STORAGE CONDITIONS: Keep product tightly sealed in original containers. Store product in a cool, dry, well-ventilated area. Store away from combustible or flammable products. Keep product packaging clean and free of all contamination, including, e.g., other pool treatment products, acids, organic materials, nitrogen-containing compounds, dry powder fire extinguishers (containing mono-ammonium phosphate), oxidizers, all corrosive liquids, flammable or combustible materials, etc.

DO NOT STORE AT TEMPERATURES ABOVE: 52 Deg.C (125 Deg.F)

Storage above this temperature may result in rapid decomposition, evolution of chlorine gas and heat sufficient to ignite combustible products.

PRODUCT STABILITY AND COMPATIBILITY

SHELF LIFE LIMITATIONS: Shelf life (that is, the period of time before the product goes below stated label strength) is determined by storage

time and temperatures. Do not store product at temperatures above 52 Deg.C (125 Deg.F). When stored under moderate temperature conditions, product will maintain stated label strength for approximately two years. Prolonged storage at 35 Deg.C (95 Deg.F) or above will significantly shorten the shelf life. Storage in a climate-controlled storage area or building is recommended in those areas where extremes of high temperature occur.

INCOMPATIBLE MATERIALS FOR PACKAGING: Product packaging must be clean and free of contamination by other materials, including, e.g., other pool treatment products, acids, organic materials, nitrogen-containing compounds, dry powder fire extinguishers (containing mono-ammonium phosphate), oxidizers, all corrosive liquids, flammable or combustible materials, etc.

INCOMPATIBLE MATERIALS FOR STORAGE OR TRANSPORT: Do not allow product to come in contact with other materials, including, e.g., other pool treatment products, acids, organic materials, nitrogen-containing compounds, dry powder fire extinguishers (containing mono-ammonium phosphate), oxidizers, all corrosive liquids, flammable or combustible materials, etc.

SECTION 4 PHYSICAL DATA

APPEARANCE: White tablet-form product

FREEZING POINT: Not Applicable

BOILING POINT: Not Applicable

DECOMPOSITION TEMPERATURE: onset - approx. 170-180 Deg.C (338-356 Deg.F)

SPECIFIC GRAVITY: Not Applicable

pH @ 25 DEG.C: 10.4-10.8 (1% soln.)

SOLUBILITY IN WATER: Approximately 18% @ 25 Deg.C. (Product contains calcium hydroxide and calcium carbonate which will leave a residue.)

BULK DENSITY: 0.8 g/cc, loose (granules), 1.9 g/cc (tablets)

VAPOR PRESSURE @ 25 DEG.C: Not Applicable

VOLATILES, PERCENT BY VOLUME: Not Applicable

EVAPORATION RATE: Not Applicable

VAPOR DENSITY: Not Applicable

MOLECULAR WEIGHT: 143 (Active ingredient)

ODOR: Chlorine-like

COEFFICIENT OF OIL/WATER DISTRIBUTION: Not Applicable

SECTION 5 PERSONAL PROTECTIVE EQUIPMENT REQUIREMENTS

PERSONAL PROTECTION FOR ROUTINE USE OF PRODUCT:

RESPIRATORY PROTECTION: Wear NIOSH approved respirator if dusts are created.

VENTILATION: Use local exhaust ventilation to minimize dust and chlorine levels where industrial use occurs. Otherwise, ensure good general ventilation.

SKIN AND EYE PROTECTIVE EQUIPMENT: Wear gloves, and safety glasses to avoid skin and eye contact. Where industrial use occurs, chemical goggles or full impermeable suit may be required.

EQUIPMENT SPECIFICATIONS (WHEN APPLICABLE):

RESPIRATOR TYPE: NIOSH approved full face-piece respirator with chlorine cartridges and dust/mist prefilter.

PROTECTIVE CLOTHING TYPE: (This includes: gloves, boots, apron, protective suit): Neoprene

SECTION 6 FIRE AND EXPLOSION HAZARD INFORMATION

01534-0003- 30045

PULSAR® PLUS DRY CHLORINATOR BRIQUETTES

Page 3 of 10

This product is chemically reactive with many substances. Any contamination of the product with other substances by spill or otherwise may result in a chemical reaction and fire. This product is a strong oxidizer which is capable of intensifying a fire once started.

FLAMMABILITY DATA:

FLAMMABLE: No
 COMBUSTIBLE: No
 PYROPHORIC: No
 FLASH POINT: Not Applicable
 AUTOIGNITION TEMPERATURE: Not Applicable
 FLAMMABLE LIMITS AT NORMAL ATMOSPHERIC TEMPERATURE AND PRESSURE (PERCENT VOLUME IN AIR): UEL - Not Applicable LEL - Not Applicable

NFPA RATINGS:

Health: 3
 Flammability: 0
 Reactivity: 1
 Special Hazard Warning: OX (OXIDIZER)

HMS RATINGS:

Health: 3
 Flammability: 0
 Reactivity: 1

EXTINGUISHING MEDIA:

Water only

FIRE FIGHTING TECHNIQUES AND COMMENTS:

Use water to cool containers exposed to fire. Also see Section XI.
 OTHER: Do not use dry extinguishers containing ammonium compounds

SECTION 7 REACTIVITY INFORMATION

CONDITIONS UNDER WHICH THIS PRODUCT MAY BE UNSTABLE:

TEMPERATURES ABOVE: 170 Deg.C (338 Deg.F)
 MECHANICAL SHOCK OR IMPACT: No
 ELECTRICAL (STATIC) DISCHARGE: No
 HAZARDOUS POLYMERIZATION: Will not occur
 INCOMPATIBLE MATERIALS: This product is chemically reactive with many substances, including, e.g., other pool treatment products, acids, organics, nitrogen-containing compounds, dry powder fire extinguishers (containing mono-ammonium phosphate), oxidizers, corrosive, flammable or combustible materials.
 HAZARDOUS DECOMPOSITION PRODUCTS: Chlorine gas
 OTHER CONDITIONS TO AVOID: Storage at temperatures >125 Deg.F (52 Deg.C)
 Prevent ingress of humidity and moisture into container or package.
 Always close the lid.

SUMMARY OF REACTIVITY: (See also Section VI)

OXIDIZER: Yes
 PYROPHORIC: No
 ORGANIC PEROXIDE: No
 WATER REACTIVE: No
 OTHER: Arch calcium hypochlorite products meet the specifications of ASTM method E-487-74 as set forth in 49 C. F. R. Sec. 173.21,

Title 49-Code of Federal Regs. (DOT Regs.)

SECTION 8 FIRST AID

EYES: Immediately flush with large amounts of water for at least 15 minutes, occasionally lifting the upper and lower eyelids. Call a physician at once.

SKIN: Immediately flush with water for at least 15 minutes. Call a physician. If clothing comes in contact with the product, it should be removed immediately and laundered before reuse.

INGESTION: Immediately drink large quantities of water. DO NOT induce vomiting. Call a physician at once. DO NOT give anything by mouth if the person is unconscious or if having convulsions.

INHALATION: Remove victim to fresh air. Support respiration if needed. Call a physician.

SECTION 9 TOXICOLOGY AND HEALTH INFORMATION

ROUTES OF ABSORPTION

Inhalation, skin and eye contact, ingestion

WARNING STATEMENT AND WARNING PROPERTIES

MAY BE FATAL IF SWALLOWED. AVOID BREATHING DUST OR FUMES. HARMFUL IF PRODUCT IS INHALED IN HIGH CONCENTRATIONS. CAUSES SKIN, EYE, DIGESTIVE TRACT AND RESPIRATORY TRACT BURNS.

HUMAN RESPONSE DATA

ODOR THRESHOLD: Approximately 1.4 mg/cubic-meter, based on odor threshold of chlorine.

IRRITATION THRESHOLD: Approximately 13-22 mg/cubic meter, based on the irritation threshold of chlorine.

IMMEDIATELY DANGEROUS TO LIFE OR HEALTH: Approximately 45 mg/cubic-meter, based on IDLH concentration of chlorine.

SIGNS, SYMPTOMS, AND EFFECTS OF EXPOSURE

INHALATION

ACUTE:

Inhalation of dust or vapor from this product can be irritating to the nose, mouth, throat and lungs. In confined areas, mechanical agitation can result in high levels of dust, and reaction with incompatible materials (as listed in Section VII) can result in high concentrations of chlorine vapor, either of which may result in burns to the respiratory tract, producing lung edema, shortness of breath, wheezing, choking, chest pains, impairment of lung function and possible permanent lung damage.

CHRONIC:

Chronic (repeated) inhalation exposure may cause impairment of lung function and permanent lung damage.

EYE

Severe irritation and/or burns can occur following eye exposure. Contact may cause impairment of vision and corneal damage.

SKIN

ACUTE:

Dermal exposure can cause severe irritation and/or burns characterized by redness, swelling and scab formation. Prolonged skin exposure may cause permanent damage.

CHRONIC:

Effects from chronic skin exposure would be similar to those from single exposure except for effects secondary to tissue destruction.

INGESTION**ACUTE:**

Irritation and/or burns can occur to the entire gastrointestinal tract, including the stomach and intestines, characterized by nausea, vomiting, diarrhea, abdominal pain, bleeding and/or tissue ulceration. Due to the corrosive nature of this product, ingestion may be fatal.

CHRONIC:

There are no known or reported effects from chronic exposure except for effects similar to those experienced from single exposure.

MEDICAL CONDITIONS AGGRAVATED BY EXPOSURE

Asthma, respiratory and cardiovascular disease

INTERACTIONS WITH OTHER CHEMICALS WHICH ENHANCE TOXICITY

None known or reported

ANIMAL TOXICOLOGY**ACUTE TOXICITY:**

Inhalation LC 50: Approximately 1300 mg/cubic-meter (1 hr., rat) -
based on acute inhalation toxicity for chlorine

Oral LD 50: 850 mg/kg. (rat)

Dermal LD 50: > 2 g/kg. (rabbit)

Causes burns to eyes and skin

ACUTE TARGET ORGAN TOXICITY:

This product may be severely irritating and/or corrosive to all tissues contacted and upon inhalation, may cause irritation to the mucous membranes and upper respiratory tract.

CHRONIC TARGET ORGAN TOXICITY:

There are no known or reported effects from repeated exposure.

REPRODUCTIVE TOXICITY:

Calcium hypochlorite has been tested for teratogenicity in laboratory animals. Results of this study have shown that calcium hypochlorite is not a teratogen.

CARCINOGENICITY:

This product is not known or reported to be carcinogenic by any reference source, including: IARC, OSHA, NTP or EPA.

One hundred mice were exposed dermally 3 times a week for 18 months to a solution of calcium hypochlorite. Histopathological examination failed to show an increased incidence of tumors.

IARC (International Agency for Research on Cancer) reviewed studies conducted with several hypochlorite salts. IARC has classified hypochlorite salts as having inadequate evidence for carcinogenicity

to humans and animals. IARC therefore considers hypochlorite salts to be not classifiable as to their carcinogenicity to humans.

MUTAGENICITY:

Calcium hypochlorite has been tested in the Dominant lethal assay in male mice, and it did not induce a dominant lethal response.

Calcium hypochlorite has been reported to produce mutagenic activity in two in vitro assays. It has, however, been shown to lack the capability to produce mutations in animals based on results from the micronucleus assay. In vitro assays frequently are inappropriate to judge the mutagenic potential of bactericidal chemicals due to a high degree of cellular toxicity. The concentration which produces mutations in these in vitro assays is significantly greater than the concentrations used for disinfection. Based on high cellular toxicity in in vitro assays and the lack of mutagenicity in animals, the risk of genetic damage to humans is judged not significant.

AQUATIC TOXICITY:

Bluegill, 96 hr. LC50: 0.088 mg/l (nominal, static)
Rainbow trout, 96 hr. LC50: 0.16 mg/l (nominal, static)
Daphnia magna, 48 hr. LC50: 0.11 mg/l (nominal, static)

TOXICITY TO WILDLIFE:

Bobwhite quail, dietary LC50: > 5,000 ppm
Mallard ducklings, dietary LC50: > 5,000 ppm
Bobwhite quail, oral LD50: 3474 mg/kg.

SECTION 10 TRANSPORTATION INFORMATION

THIS MATERIAL IS REGULATED AS A DOT HAZARDOUS MATERIAL.

DOT DESCRIPTION FROM THE HAZARDOUS MATERIALS TABLE 49 CFR 172.101:
LAND (U.S. DOT): CALCIUM HYPOCHLORITE MIXTURES DRY, 5.1, UN 1748,
PG2

WATER (IMO): SAME AS ABOVE

AIR (IATA/ICAO): SAME AS ABOVE

HAZARD LABEL/PLACARD: OXIDIZER

REPORTABLE QUANTITY: 10 lbs. (Per 49 CFR 172.101, Appendix)

EMERGENCY GUIDE NO: 45

SECTION 11 SPILL AND LEAKAGE PROCEDURES

FOR ALL TRANSPORTATION ACCIDENTS, CALL CHEMTREC AT 800-424-9300.
REPORTABLE QUANTITY: 10 lbs. (as Calcium hypochlorite) Per 40 CFR 302.4

SPILL MITIGATION PROCEDURES:

Hazardous concentrations in air may be found in local spill area and immediately downwind. Remove all sources of ignition. Stop source of spill as soon as possible and notify appropriate personnel.

AIR RELEASE: Vapors may be suppressed by the use of a water fog. All water utilized to assist in fume suppression, decontamination or fire suppression may be contaminated and must be contained before disposal and/or treatment.

WATER RELEASE: This material is heavier than water. This material is soluble in water. Monitor all exit water for available chlorine and pH. Advise local authorities of any contaminated water release.

LAND SPILL: Contact at 1-800-6546-911 immediately.
DANGER: All spills of this product should be treated as contaminated. Contaminated product may initiate a chemical reaction which may spontaneously ignite any combustible material present, resulting in a fire of great intensity. In case of a spill, separate all spilled product from packaging, debris and other material. Using a clean broom or shovel, place all spilled product into plastic bags, and place those bags into a clean, dry disposal container, properly marked and labelled. Disposal containers made of plastic or metal are recommended. Do not seal disposal containers tightly. Immediately remove all product in disposal containers to an isolated area outdoors. Place all damaged packaging material in a disposal container of water to assure decontamination (i.e. removal of all product) before disposal. Place all undamaged packaging in a clean, dry container properly marked and labelled. Call for disposal procedures.

SPILL RESIDUES:

Dispose of per guidelines under Section 12, WASTE DISPOSAL. This material may be neutralized for disposal; you are requested to contact at 800-6546-911 before beginning any such operation.

PERSONAL PROTECTION FOR EMERGENCY SPILL AND FIRE-FIGHTING SITUATIONS:

Response to this material requires the use of a full encapsulated suit and a NIOSH approved positive pressure supplied air respirator.

SECTION 12 WASTE DISPOSAL

If this product becomes a waste, it meets the criteria of a hazardous waste as defined under 40 CFR 261 and would have the following EPA hazardous waste number: D001.

If this product becomes a hazardous waste, it will be a hazardous waste which is subject to the Land Disposal Restrictions under 40 CFR 268 and must be managed accordingly.

As a hazardous solid waste, it must be disposed of in accordance with local, state, and federal regulations in a permitted hazardous waste treatment, storage and disposal facility by treatment.

CARE MUST BE TAKEN TO PREVENT ENVIRONMENTAL CONTAMINATION FROM THE USE OF THIS MATERIAL. THE USER OF THIS MATERIAL HAS THE RESPONSIBILITY TO DISPOSE OF UNUSED MATERIAL, RESIDUES AND CONTAINERS IN COMPLIANCE WITH ALL RELEVANT LOCAL, STATE AND FEDERAL LAWS AND REGULATIONS REGARDING TREATMENT, STORAGE AND DISPOSAL FOR HAZARDOUS AND NONHAZARDOUS WASTES.

SECTION 13 ADDITIONAL REGULATORY STATUS INFORMATION

TOXIC SUBSTANCES CONTROL ACT:

01534-0003- 30045
PULSAR® PLUS DRY CHLORINATOR BRIQUETTES

Page 8 of 10

This substance is listed on the Toxic Substances Control Act inventory.

NSF LIMITS: NSF Maximum Drinking Water Use Concentration - 46 mg/l
as calcium hypochlorite

SUPERFUND AMENDMENTS AND REAUTHORIZATION ACT TITLE 3:

HAZARD CATEGORIES, PER 40 CFR 370.2:

HEALTH:

Immediate (Acute)

PHYSICAL:

Fire and Reactivity

EMERGENCY PLANNING AND COMMUNITY RIGHT TO KNOW, PER 40 CFR 355, APP.A:

EXTREME HAZARDOUS SUBSTANCE - THRESHOLD PLANNING QUANTITY:

None Established

SUPPLIER NOTIFICATION REQUIREMENTS, PER 40 CFR 372.45:

None Established

SECTION 14 ADDITIONAL INFORMATION

REGULATED UNDER FIFRA, USDA & FDA

MSDS REVISION STATUS: Changes have been made to Sections 5, 9 and 11.

SECTION 15 MAJOR REFERENCES

1. Ishidate, M. et al. (1984). Primary mutagenicity screening of food additives currently used in Japan. *Fd. Chem. Toxicol.* 22:623-636.
2. Hayashi, M. et al. (1988). Micronucleus tests in mice on 39 food additives and eight miscellaneous chemicals. *Fd. Chem. Toxicol.* 26:487-500.
3. Report on the Acute Inhalation in Rats, Acute Oral LD50 in Rats, Eye Irritation in Rabbits, Dermal Irritation in Rabbits, and Acute Dermal Toxicity in Rabbits of HTH. Biometric Testing Laboratories, Inc., Whippany, NJ. Experiment Reference #A-1490 (RC-30406), February 9, 1975.
4. Report on the Teratogenic Study with Calcium Hypochlorite in Albino Rats. Industrial Bio-Test Laboratories, Inc., Northbrook, IL. IBT #B758b, April 18, 1972.
5. Report on the Mutagenic Study with Monosodium Cyanurate and Calcium Hypochlorite (HTH) in Albino Mice. Industrial Bio-Test Laboratories, Inc., Northbrook, IL. IBT #E756. April 18, 1972.
6. Chemical Hazard Summary No. 20: Calcium Hypochlorite. Canadian Centre for Occupational Health and Safety, Hamilton, Ontario, Canada L8N 1H6. December 1986.
7. Report on 18-Month Dermal Carcinogenicity Study with Monosodium Cyanuric Acid and HTH in Swiss White Mice. Industrial Bio-Test Laboratories, Inc., Northbrook, IL, IBT #651-00751, April 9, 1974.
8. Report to PPG Industries, Inc. on the Acute Toxicity Studies with PITTCHLOR (Granular Calcium Hypochlorite). Industrial Bio-Test Laboratories, Inc., Northbrook, IL, IBT #601-06659, May 7, 1975.
9. Report on the Acute Toxicity of HTH to Bluegill, Rainbow Trout and the Water Flea. E G & G, Bionomics Aquatic Toxicology Laboratory, Wareham, MA, July 1977.
10. Report on the 8-Day Dietary LD50 Study with HTH in Mallard Ducklings. Industrial Bio-Test Laboratories, Inc., Northbrook, IL, IBT #651-

06184,

01534-0003- 30045

PULSAR® PLUS DRY CHLORINATOR BRIQUETTES

Page 9 of 10

- May 15, 1975.
11. Report on the 8-Day Dietary LC50 with HTH in Bobwhite Quail. Industrial Bio-Test Laboratories, Inc., Northbrook, IL, IBT #651-06183.
 12. Final Report on the Acute Oral LD50 of Calcium Hypochlorite in Bobwhite Quail. Wildlife International, LTD., Easton, MD, Project #133-107, July 15, 1977.
 13. IARC Monographs on the Evaluation of Carcinogenic Risks to Humans. Vol.52: Chlorinated Drinking Water; Chlorination By-Products; Some Other Halogenated Compounds; Cobalt and Cobalt Compounds. World Health Organization, International Agency for Research on Cancer (IARC), Lyon, France, 1991.
 14. Sittig, Marshall, Handbook of Toxic and Hazardous Chemicals and Carcinogens, 2nd Ed., Noyes Publications, Park Ridge, NJ, 1985.
 15. Chemical Hazard Response Information System (CHRIS), Vol. II, U.S. Coast Guard, Washington, D.C., 1984.
 16. Chlorine and Your Health. The Chlorine Institute, Inc., Washington, D.C., August 1988.
 17. ACGIH Documentation of the Threshold Limit Values and Biological Exposure Indices, Sixth Edition, 1991. American Conference of Governmental Industrial Hygienists, Inc., Cincinnati, OH.
 18. Amoores, John E. and Earl Hautala, Odor as an Aid to Chemical Safety: Odor Thresholds Compared with Threshold Limit Values and Volatiles for 214 Industrial Chemicals in Air and Water Dilution. Journal of Applied Toxicology, Vol. 3, No. 6, pp. 272-290, 1983.
 19. Forsberg, K., and S.Z. Mansdorf, Quick Selection Guide to Chemical Protective Clothing, Second Edition, Van Nostrand Reinhold, N.Y., 1993.

Additional references are available upon request.

THIS MATERIAL SAFETY DATA SHEET (MSDS) HAS BEEN PREPARED IN COMPLIANCE WITH THE FEDERAL OSHA HAZARD COMMUNICATION STANDARD, 29 CFR 1910.1200. THE INFORMATION IN THIS MSDS SHOULD BE PROVIDED TO ALL WHO WILL USE, HANDLE, STORE, TRANSPORT, OR OTHERWISE BE EXPOSED TO THIS PRODUCT. THIS INFORMATION HAS BEEN PREPARED FOR THE GUIDANCE OF PLANT ENGINEERING, OPERATIONS AND MANAGEMENT AND FOR PERSONS WORKING WITH OR HANDLING THIS PRODUCT. ARCH CHEMICALS BELIEVES THIS INFORMATION TO BE RELIABLE AND UP TO DATE AS OF THE DATE OF PUBLICATION BUT, MAKES NO WARRANTY THAT IT IS. ADDITIONALLY, IF THIS MSDS IS MORE THAN THREE YEARS OLD, YOU SHOULD CONTACT ARCH CHEMICALS MSDS CONTROL AT THE PHONE NUMBER ON THE FRONT PAGE TO MAKE CERTAIN THAT THIS DOCUMENT IS CURRENT.

Arch Chemicals, Inc.
 MSDS Control
 501 Merritt 7
 PO Box 5204
 Norwalk, CT 06856-5204

10.6 Pulsar 1 Operator's Manual



Operator's Manual

Model # SF-3W



Arch Chemicals, Inc.
1200 Lower River Road, P.O. Box 800
Charleston, TN 37310-0800

1-800-4-PULSAR

09/5/03

Rev. 1

Dealer Contact:

Product Stewardship
MAKING THE WORLD A BETTER PLACE



Arch is committed to maintaining and improving our leadership in Product Stewardship. One of the six initiatives outlined under the Chemical Manufacturers Association (CMA) Responsible Care[®] Program, its purpose is to make health, safety, and environmental protection an integral part of a product's life cycle – from manufacture, marketing, and distribution to use, recycling, and disposal.

Successful implementation is therefore, a shared responsibility. Everyone involved with the product has responsibilities to address society's interest in a healthy environment and in products that can be used safely. We are each responsible for providing a safe workplace, and all who use and handle products must follow safe and environmentally sound practices.

For more information about our Product Stewardship Program, contact your Arch Representative.

THE MAJOR COMPONENTS - HOW THEY WORK

General Principles of Operation

The three main components of the Pulsar® 1 Chlorinator are (from top to bottom) the briquette Hopper, the Dissolving Cup section and the Discharge Tank. The water from the pool enters the Pulsar® 1 Chlorinator via the emergency shutoff valve. The water then enters the base of the Dissolving Cup where it splits to feed the nozzles for generating the wave to penetrate into the Briquette bed and the solids removal system. The chlorinated solution is directed by a single outlet spout to a channel that directs the solids and chlorinated solution into the discharge tank where it is discharged into the pool recirculation system. The amount of chlorine discharged is determined by the flow rate into the chlorinator. An ORP controller can be used to regulate chlorinator output by installing a solenoid on the inlet flow line.

Inlet water pressure of 2 to 20 psi will provide sufficient flow into the Pulsar® 1. These pressures will result in an inlet flow rate of 0.2-1.05 gpm. The Pulsar® 1 feed rate settings referred to in the Pulsar System Owners manual are calibrated for these flow rates.

Flow out of the Pulsar® 1 feeder requires vacuum to properly evacuate the discharge tank. A minimum outlet flow-rate of 1.1 gallons/minute ensures that the flow outlet flow of the Pulsar® 1 exceeds the flow in. Once the Pulsar® 1 has been installed the outlet flow can be measured by watching the level in the Discharge tank. If the level is rising as the feeder is running, there is insufficient flow out.

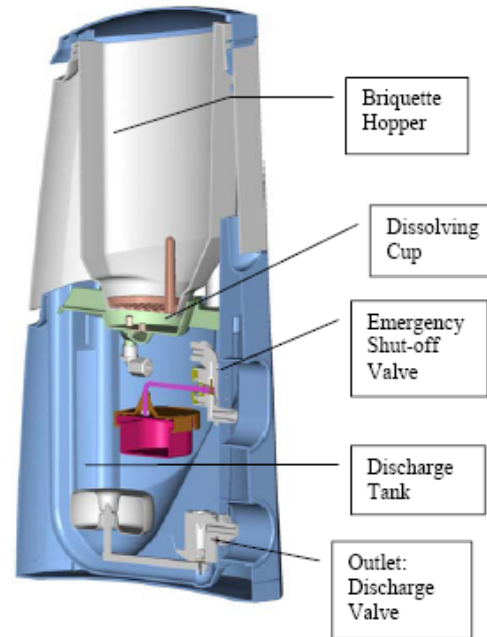

SPECIFICATIONS – Model SF-3W

Operational Requirements:

Inlet pressure (Range)	2-20 psi
Ideal	12 psi
Outlet vacuum	3-29" Hg.
Operating Temperature	40-130°F

Operational Characteristics

Inlet flow (gpm)	0.2-1.05
Outlet flow (Min)	1.1 gpm

Note: To Maintain NSF approval a flow indicator must be installed.

Dimensions:

Tubing	1/2" O.D. Polyethylene
Chlorinator dimensions	W13"xD15"
Chlorinator height	31"
Chlorinator weight (full)	42 lbs
Chlorinator weight (empty)	17 lbs

Hopper Capacity

28 lbs. Pulsar® Plus Briquettes

Feed Rate:

Pulsar® Plus Briquettes: 0.5-28 lbs. of Available Chlorine per day
Recommended Pool Size¹
500-35,000 gallon un-stabilized
1,000-70,000 gallon stabilized

¹ Subject to local health codes

PRE-START-UP CHECKLIST

Following the procedure outlined below will ensure a smooth start-up of the Pulsar 1 Chlorinator. For seasonal operation, perform this procedure each spring.

IMPORTANT!!

Do **NOT** put Pulsar® Plus Briquettes in the chlorinator during the start-up operation.

INLET WATER FLOW

The inlet water flow system is designed to provide a steady side-stream of clean filtered pool water to the chlorinator.

1. Switch on the pool recirculation system, and open all valves to the chlorinator. Leave lid closed.
2. Adjust Inlet flow on flow indicator to 0.4 gpm. Wait 10 seconds and open lid slowly.
3. Check to see that the wave nozzle is making a wave that rises into the Briquette grid. Remove the grid to see if water is flowing from the Solids Removal Nozzle.
4. Check all lines leading to the Chlorinator for leaks. Hand tighten all fittings if any leaks are found.

OUTLET WATER FLOW

The float on the Discharge Valve rises with the water level and allows the venturi suction to draw the chlorinated water into the pool's recirculation system as the Discharge Tank fills with water. When the water level drops, the float falls, shutting off the valve. The Discharge Valve also contains a check valve to prevent pool water from backing up into the Discharge Tank. Use the following procedure to ensure that the outlet water flow system is operating properly.

1. With the briquette hopper and dissolving cup of the chlorinator temporarily out of the way, fill the Discharge Tank with sufficient water to open the Discharge Valve – use a hose or pail.
2. The float should rise, opening the Discharge Valve, allowing water to be drawn out by the Pulsar® venturi system.
3. Check the system for leaks. If small air bubbles are visibly moving, there may be an air leak. Tighten the connectors and make sure that the tubing was properly installed in the fittings. (NOTE: Air bubbles near the Pulsar® 1 Chlorinator body that do not move are normal and do not indicate leaks.)
4. Check for air leaks after the Discharge Valve closes.

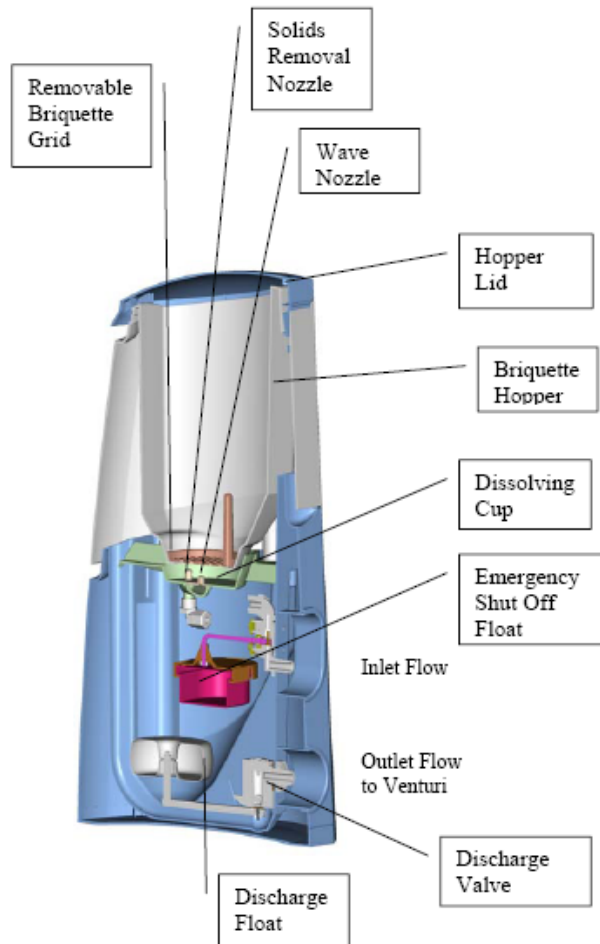

START-UP PROCEDURES

After completing the PRE-START-UP CHECKLIST, and establishing that all components of the chlorinator are operating properly, your PULSAR® 1 Chlorinator is ready for start-up.

Routine maintenance of the PULSAR® 1 Chlorinator is minimized when proper pool water balance is maintained. Maintain pool water chemistry as follows:

Total Alkalinity	60-80ppm
Calcium Hardness	200-1800ppm
pH	7.2-7.6

Adherence to these recommendations at all times will ensure the most effective and economical performance from the PULSAR® 1 Chlorinator.

NOTE: The use of CO₂ to lower pH will raise Total Alkalinity. High total alkalinity (over 80 ppm) will increase scale and solids buildup in chlorinator.

WARNING

Use **ONLY** Pulsar® Plus Briquettes in the Chlorinator. The use of any other treatment chemicals will void the warranty and NSF listing. **DANGER:** Under no circumstances mix calcium hypochlorite with other forms of concentrated chlorine or other chemicals. Fire and/or explosion may result. Caution must be used when refilling dispenser.

KEEP OUT OF REACH OF CHILDREN

1. Fill the Briquette Tank with Pulsar® Plus Briquettes. The Briquette Tank holds 28 pounds of briquettes.
2. Open all valves to the pool and the outlet ball valve of the chlorinator.
3. Check the chart below to determine an approximate start-up Inlet Flow setting for your pool (or be certain that the ORP Controller is calibrated and the set-points are correct). Set the Flow Indicator at the recommended setting using the inlet ball valve. Note: For best chlorinator performance with an ORP controller, set the flow indicator for a pool 30% larger than the one at your facility. This will assist in maintaining desired Free Available chlorine level in pool without overshooting ORP set point.
4. Monitor the water flow to the chlorinator daily to ensure that a proper flow is being maintained.
5. During the first few days of operation, check chlorine level in the pool frequently to establish the best Inlet Flow setting (or ORP Controller setting) for your pool. Adjust the chlorine output either up or down according to the table, or adjust the ORP setpoint.

Output Rate and Start-up Settings for Commercial Pools and Spas Vs. Inlet Flow Rates

Inlet Flow Rate (gpm)	Av Cl lbs/day	Stabilized Pool (Gal)	Un-Stabilized Pool (Gal)	Comm. Spa (Gal)
0.2	0.5	5000	1250	500
0.25	1.6	16000	4000	1600
0.3	2.2	22000	5500	2200
0.35	3.3	33000	8000	3300
0.4	4.5	45000	11000	4500
0.45	5.5	55000	14000	5500
0.5	8.9	89000	22000	8900
0.55	10.8	108000	27000	10800
0.6	12.6	126000	31000	
0.65	13.3	133000	33000	
0.7	14	140000	35000	
0.75	15.5	155000	39000	
0.8	17	170000	42500	
0.85	19	190000	47500	
0.9	21	210000	52500	
0.95	23	230000	57500	
1	25	250000	62500	
1.05	28	280000	70000	

PULSAR® 1 CHLORINATOR INSPECTION AND MAINTENANCE

Calcium Hypochlorite by the nature of its manufacture, contains a small amount of calcium carbonate. Proper water balance will minimize the buildup of calcium carbonate solids in the Pulsar® 1 Chlorinator, however, periodic cleaning of chlorinator components is normal and recommended. The following is a list of the parts to be cleaned and the proper procedures to do so.

TABLE OF CONTENTS

Suggested Inspection Frequency	Section	Contents
As Needed	Section A:	Use of PULSAR® Plus Acid Cleaner 50 to remove solids and scale from the Pulsar® 1 Chlorinator
As Needed	Section B	Troubleshooting Guide

SECTION A

Cleaning PULSAR® 1 Chlorinator with PULSAR® Plus Acid Cleaner 50

Inspection: The solids build-up and cleaning frequency required for the unit will depend on the amount of Briquettes used and the pool water chemistry. Described below is the easiest way to remove solids and minor scale buildup using the PULSAR® Plus Acid Cleaner 50.

WARNING

Do **NOT** use Muriatic Acid to perform the following procedures. Chlorine gas may evolve causing serious injury or possible death. Use proper protective equipment per MSDS when handling chemicals.

Maintenance Procedure Steps:

Note: Record inlet flow rate setting.

1. Close the inlet and outlet shutoff valves to the chlorinator.
2. Lift the Briquette Hopper off of the Discharge Tank and pour the contents into a clean dry bucket. Be sure to remove all pieces of briquettes. If necessary, rinse any heavy solids buildup from the hopper before proceeding.
3. Lift out Dissolving cup, pour contents into a bucket and rinse out solids.
4. Remove briquette grid and place in cup (provided with system). Fill with 8 ounces of water. Slowly pour 8 ounces of PULSAR® Plus Acid Cleaner 50 into cup. Pour 1 gallon of water and ¼ quart of Acid Cleaner 50 into discharge tank. Frequent agitation may be required to dissolve solids and scale. Allow acid to dissolve solids and scale, evident by the foaming action. After 10 to 20 minutes, check for presence of scale on grid. If necessary, add additional PULSAR® Plus Acid Cleaner 50 to

dissolve any remaining scale or scrape with putty knife.

5. Replace the Dissolving Cup in Base.
6. Pour the contents from the cup with grid into dissolving cup and allow 10 minutes for scale to dissolve.
7. Put the hopper back on the base and the Briquette grid back into the bottom of the hopper. Rinse the Briquette grid thoroughly with water.
8. Pour Pulsar® Plus Briquettes from bucket back into Briquette Tank.
9. Open the outlet shut off valve to the chlorinator and adjust inlet ball valve to desired inlet flow rate.

NOTE: To increase the period between Grid cleanings, allow Briquette Tank to completely empty once a week.



SECTION B

TROUBLESHOOTER'S GUIDE

<u>PROBLEM</u>	<u>CAUSE</u>	<u>SOLUTION</u>
Insufficient water flow to chlorinator	Check water flow through nozzles. If there is scale build-up perform solution. Inlet Shutoff Valve closed Emergency Shut Off Valve in closed position Solenoid Valve not operating (ORP system only)	Rinse out dissolving cup, add 6 oz. of water and 3 oz. Pulsar Acid Cleaner 50. Let sit until scale dissolves. Open Inlet Shutoff Valve If ESV Valve is stuck, lower gently to reset Check with Dealer
Insufficient chlorine in pool	Feed rate/output too low Chlorinator empty No inlet water flow Outlet/Shutoff Valve closed Clogged Discharge Tubing Briquettes stuck together Clogged Briquette Tank Grid Clogged Venturi System	Increase feed rate by increasing inlet flow. Refill Briquette Hopper with Pulsar® Plus Briquettes See insufficient water flow section Open Outlet Shutoff Valve Refer to Section A or Replace discharge tubing Tap side of Briquette Tank to loosen Refer to Section A Remove venturi – soak in tub with 50/50 mixture of water and Pulsar Plus Acid Cleaner 50 solution.
	Closed valves in venturi system	Open venturi system valves
Excess chlorine in pool	Automatic Controller Problem Feed rate/output too high	Refer to automatic controller manual Decrease feed rate by reducing inlet flow
Air leaks	Discharge Tubing not properly installed in fittings Discharge Valve seat failure Scale prevents Discharge Valve from properly seating Pinched O-rings in Tubing Connectors	Reinstall Discharge Tubing Replace Discharge Valve Arm. Remove Discharge Valve Assembly and soak in dilute Pulsar Acid Cleaner 50 to remove scale Inspect O-rings on discharge side of feeder
Chlorinator overflow	Discharge Tubing clogged Clogged venturi system Insufficient outlet suction Emergency shutoff valve failure	Refer to Section A or Replace Discharge tubing. See clogged venturi system solution Check with Dealer Check with Dealer

WARRANTY POLICY

Pulsar® 1 Commercial Pool Chlorinator

Arch Chemicals, Inc. ("Arch") warrants equipment of its manufacture and bearing its identification to be free of defects in workmanship and material. Arch's liability under this warranty extends for a period of two (2) years (excluding electrical components which carry a 1 year warranty) from the date of installation as performed by an Authorized Commercial Dealer Representative and registered with Arch Water Chemicals via the Arch Commercial Chlorinator Warranty Registration Card. Systems for which there is no Warranty Registration Card on file carry no warranty of any kind, expressed or implied.

In addition, each system is covered by a sixty (60) day, 100% buy-back guarantee. If the original purchaser ("owner") is dissatisfied with the Pulsar® 3 Commercial Pool Chlorinator performance for any reason, they can return it to the Authorized Commercial Pool Dealer for a full refund. The equipment must have received normal use and care, and Arch must be notified in writing before the sixty (60) days have expired. There is no reimbursement for chemicals used during the sixty (60) days.

Arch disclaims all liability for damage during transportation, for consequential damage of whatever nature, for damage due to handling, installation or improper operation, and for determined suitability for the use intended by purchaser ("owner"). Arch makes no warranties, either expressed or implied, other than those stated above. No Arch Representative or Authorized Commercial Dealer Representative has authority to change or modify this warranty in any respect.

Pulsar® 1 Parts

Arch warrants equipment parts of its manufacture and bearing its identification to be free of defects in workmanship and material. Arch's liability under this warranty extends for a period of ninety (90) days from the date of installation as performed by an Authorized Commercial Dealer Representative. This warranty is restricted to Pulsar® 3 Chlorinator Parts purchased on a replacement basis.

Arch Water Chemicals, Inc.
1-800-4 PULSAR

Pulsar 1 Feeder Detailed View

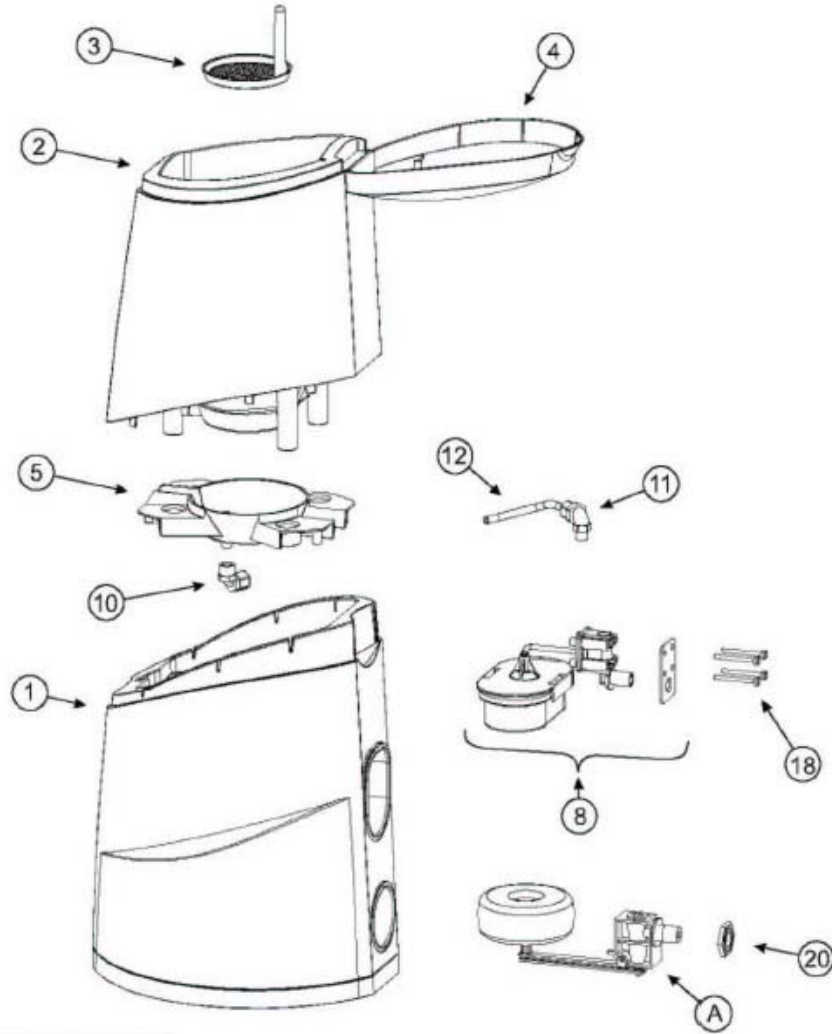

Not shown: Cleaning Pan

Revised 08-26-03

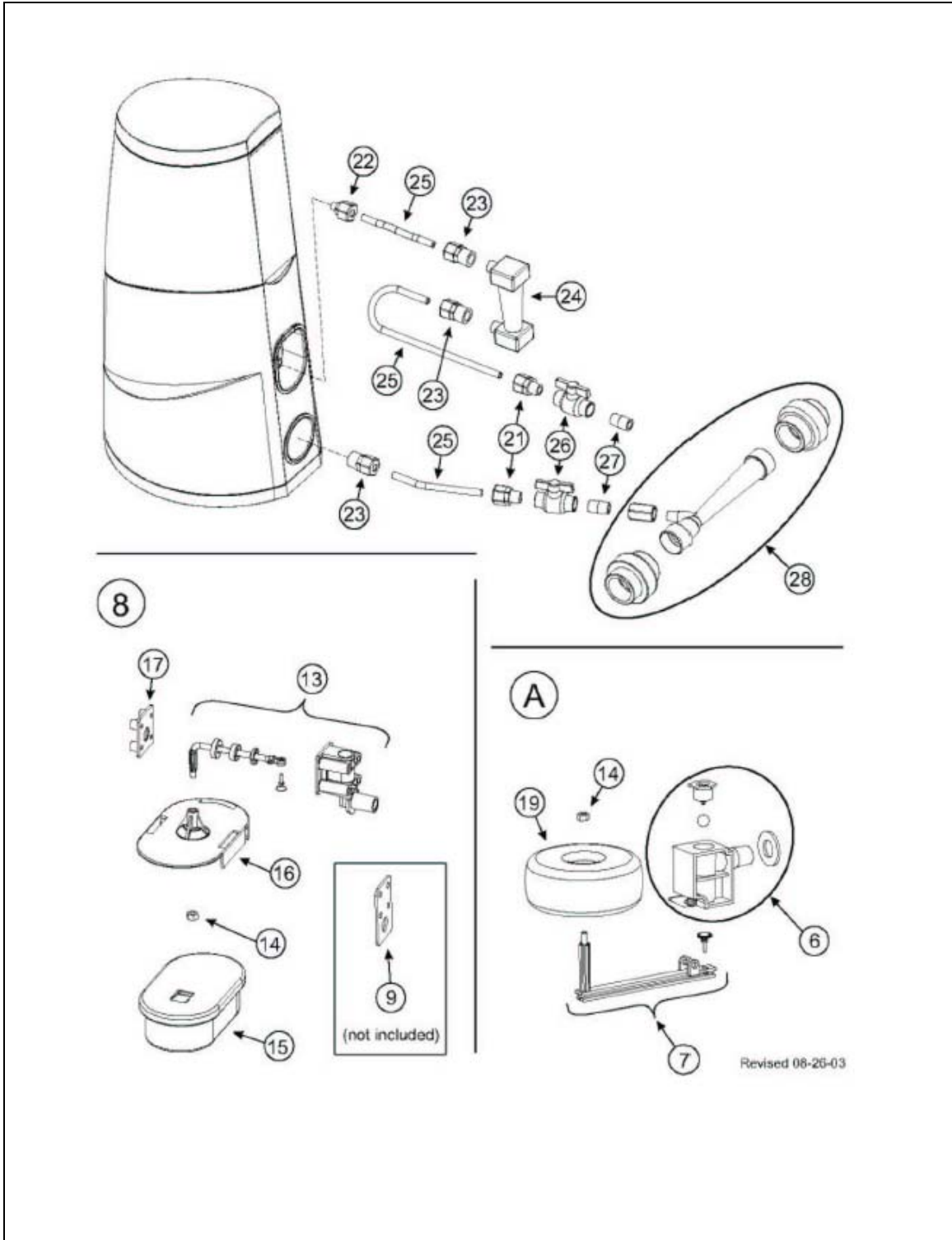

Pulsar 1

Diagram Number	Part Number	Qty	Description
0	71803	1	Pulsar 1 Feeder
1	74066	1	P1 Base
2	74065	1	P1 Hopper
3	74068	2	P1 Grid
4	74067	1	P1 Lid
5	74062	1	P1 Dissolving Cup with Nozzles Assembly
6	71615	1	Discharge Valve Body with Plug, Ball & Gasket
7	71584	1	Discharge Valve Arm with Suction Cup
8	71496	1	Emergency Shut Off Valve Assembly - Part 71910 Not Included
9	71910	1	Rubber Gasket for Emergency Shut Off Valve
10	74059	1	Parker Fitting W6FE4
11	71619	1	Elbow (W6ME6) 3/8" For Feeders 30991 & P3, P1
12	71618	1	3/8" PE Tubing (2 ft)
13	71535	1	Emergency Shut Off Valve with Arm Only
14	71538	2	Emergency Shut Off Float Plate PVC Nut/Discharge Arm Nut
15	71540	1	Emergency Shut Off Overflow Float
16	71539	1	Emergency Shut Off Float Plate
17	71536	1	Emergency Shut Off Mounting Plate
18	71537	1	Emergency Shut Off Mounting PVC Screws(1/4x20x2 1/4)
19	71585	1	Discharge Valve Float
20	71583	1	Discharge Valve Locknut
21	71890	2	Parker Fitting, W8MC8 (also for solenoid)
22	71614	1	Tube Connector (P8MC4) for P3
23	71588	3	(5008) 1/2" X 1/2" Female Connector (P8FC8)
24	74060	1	Flow Indicator - P1
25	71626	1	20' 1/2" O.D. PE Tubing(P4 only need 3 inch piece)
26	74061	2	1/2" FNPT x 1/2" FNPT PVC Ball Valve
27	71611	2	1/2" X close PVC Nipple
28	71974	1	ORP/Below Grade Installation Kit for Small Feeder
29	74145	1	P1 Cleaning Pan

Number 29 not pictured

9/10/2003



Arch Chemicals, Inc. Emergency Action Network (ACEAN)

The Arch Chemicals, Inc. Emergency Action Network ("ACEAN") is Arch's emergency action system. Call the ACEAN system at 1-800-654-6911 in North America, and at (Country Code for the United States) 423-780-2970 elsewhere in the world. The ACEAN system is available 24 hours a day, 7 days a week for assistance with spills, injuries and emergencies of any kind. It uses computers and other systems to make Arch's environmental, technical transportation, toxicological and other expertise about its products readily available to anyone needing assistance. The ACEAN system also includes emergency response teams capable of providing on-site support throughout North America.

(800) 654-6911

(From outside North America, call after the country code for the US, 423-780-2970)

Additionally, in the event of an emergency, CHEMTREC (Chemical Transportation Emergency Center) should be contacted. CHEMTREC is a national center established by the Chemical Manufacturers Association (CMA) in Washington, DC, to relay pertinent emergency information concerning specific chemicals on request.

CHEMTREC has a 24-hour toll-free telephone number (800) 424-9300, intended primarily for use by those who respond to chemical transportation emergencies. CHEMTREC may also be accessed through the CMA website at www.cmahq.com.

Material Safety Data Sheets (MSDS) sheets can be ordered by contacting (800)-511-MSDS.

If you would like a copy of this manual in another language
please call:

1-800-4-PULSAR