

Rapid Tooling for Sheet Metal Forming Using Profiled Edge Laminations—Design Principles and Demonstration

D. F. Walczyk

Assistant Professor,
Dept. of Mechanical Engineering,
Aeronautical Engineering & Mechanics,
Rensselaer Polytechnic Institute,
Troy, New York 12180-3590

D. E. Hardt

Professor,
Laboratory for Manufacturing
and Productivity,
Massachusetts Institute of Technology,
Cambridge, Massachusetts 02139

Sheet metal forming dies constructed of laminations offer advantages over more conventional tooling fabrication methods (e.g. CNC-machining) in terms of tooling accessibility, reduced limitations on die geometry and faster fabrication with harder die materials. Furthermore, the recently introduced Profiled Edge Lamination (PEL) tooling method improves upon other lamination-based tooling methods. Adoption of this promising rapid tooling method by industry is being hindered by the lack of formal analysis, design principles, and manufacturing requirements needed to construct dies in such a manner. Therefore, the propensity for delamination of the die is discussed and preventive measures are suggested. The basic machining instructions, i.e., an array of points and directional vectors for each lamination, are outlined for both compound and planar profiled-edge bevels. Laser, AWJ and flute-edge endmilling are experimentally identified as the most promising methods for machining bevels. Development of a stand-alone PEL fabrication machine is suggested over retrofitting commercially-available 5-axis machines. Finally, the general procedure for creating PEL dies is implemented in the construction of a matched set of sheet metal forming tools. These tools are used to successfully stamp a sheet metal part out of draw-quality steel.

1 Introduction and Background

The concept of making intricate parts (e.g. transformer core, door lock assembly, gear) by assembling profiled or contoured laminations is a well-established manufacturing technique (Berry, 1966). Unfortunately this fabrication method, with demonstrable advantages over other more conventional methods (e.g., CNC-machining), has not become a common method for making sheet metal forming dies. There have been many attempts to develop it for this purpose. Hart (1942) demonstrated the idea of mold making with a laminated construction for the shoe-making industry. Recesses between laminations were filled with some hardenable material to form a smooth surface of which the edges are the laminations. Clevenger et al. (1954) patented a laminated die concept for hydroforming. One of the first methods for automatically generating an *array of contoured laminations* used as a die was developed by DiMatteo (1976). It involves rotating a 3-D model of the desired surface about an axis while a contour follower, which is connected to a transducer, is used to run a lamination cutter. Kunieda and Nakagawa (1984) successfully created a sheet metal forming die made of horizontally-oriented laminations by slicing up a CAD model of the 3-D forming surface and using the resulting data to CNC laser-cut the required contours out of sheet material. The contoured laminations were secured to one another by a combination of cementing with adhesives, clamping with bolts, and laser-welding the edges. Nakagawa et al. (1985) formed a solid sheet metal forming tool out of stacked laminations simply by diffusion-bonding the laminations together. Pridham et al. (1993) created a similar type of tool that was bonded at the lamination edges by laser welding. Recently, Dickens et al. (1996) created a tool made of aluminum laminations for molding polyurethane parts. In these last two cases, the lamination

edges were cut normal to the surface and not beveled. This resulted in a stair-stepped profile that needed to be CNC-machined with finishing cuts, ground and then polished in order to achieve the required surface smoothness for forming.

Besides CNC-machining, industry deals with this stair-stepped profile of laminated die surfaces in other ways. One of the most common methods is to fill in the steps with epoxy or some other hard material. Another method is to make the laminations very thin so that the resulting steps between laminations become negligible. For instance, a Laminated Object Manufacturing (LOM) machine can be used to create a forming die for low force forming. The surface of these dies is nearly smooth surfaces since laminations are as thin as 0.05 mm. However, the biggest limitation with current LOM paper/adhesive models is that they have low compressive strength (26 MPa). This is one-fifth the compressive strength of the cast epoxy (140 MPa) that is used in forming dies.

Weaver (1991) was granted a patent for a laminated tooling similar to that of Clevenger (1954) except that the contours machined into each lamination have beveled edges as shown in Fig. 1(a). This simple change in the art significantly reduces the time required to grind and polish the die surface. Glozer and Brevick (1993) created a laminated injection molding tool using this same method. Machined laminations were cut with very slight bevel cuts using a wire-type EDM and then assembled them into a mold that required very little additional processing.

Walczyk and Hardt (1994) recently introduced Profiled Edge Lamination (PEL) method for constructing sheet metal forming dies. As seen in Fig. 1(b), a PEL die generally comprises an array of individual die laminations, each being disposed in a vertical plane and stacked together side-by-side. The top edge of each die lamination is simultaneously profiled and beveled in such a way as to approximate a segment of the intended die surface with a first-order interpolation in the X-direction. This eliminates the stair-step surface associated with previous meth-

Contributed by the Manufacturing Engineering Division for publication in the JOURNAL OF MANUFACTURING SCIENCE AND ENGINEERING. Manuscript received Nov. 1996; revised Aug. 1997. Associate Technical Editor: C. H. Menq.

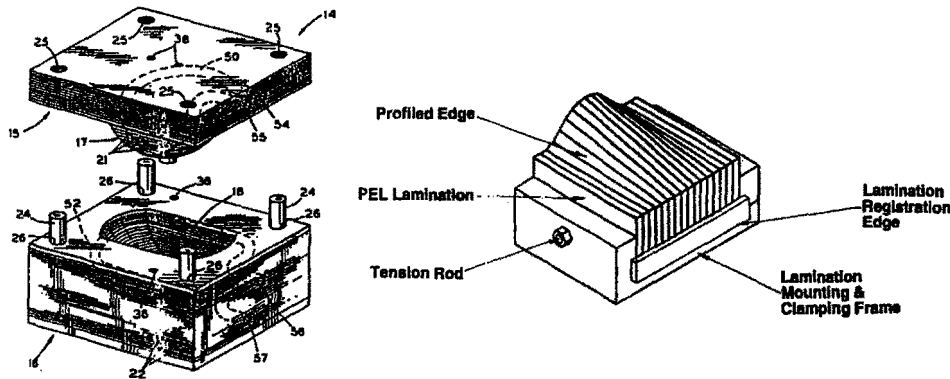

Fig. 1 Isometric view of (a) a bonded stack of contoured laminations (from Weaver, 1991) and (b) a PEL array clamped in the die frame

ods. The die lamination members may be held together in a stacked array by any suitable means, but preferably with a clamping frame as shown in Fig. 1(b). A common registration corner and the bottom edge of each lamination allows for easy and uniform registration in the clamping frame. One or more holes uniformly positioned in the sides of each lamination allows the whole array to be clamped. Therefore, no adhesive or other means of holding the array of die lamination members together is required. If the shape of the forming surface has to be changed during die development, the die laminations can easily be separated for re-machining to update the die shape. The PEL die can be made into a solid die apart from this process by suitable means (e.g. diffusion bonding, brazing) if needed or desired. Generally at least a portion of the die lamination members have a continuously changing beveled top edge. When placed together in a vertical stacked array, the top edges of the die lamination members, in the aggregate, form the top surface of the die.

The PEL array construction has distinct advantages over contoured lamination stack method used by Weaver (1991) and Kunieda and Nakagawa (1984) for creating and modifying sheet metal forming dies. These advantages are summarized in Table 1. In this paper, the authors address the design and analysis principles for the PEL die fabrication method applied to sheet metal forming.

2 Propensity for PEL Die Delamination

If the PEL die laminations are bonded together then the composite structure becomes a continuous die. However, to keep the PEL die easily remachinable, the die laminations are simply clamped together with a rigid frame as shown in Fig. 1(b). In a clamped configuration, individual laminations have a propensity to delaminate (i.e. separate from adjacent laminations) by either elastically deforming or buckling under the high forming loads encountered. As seen in Fig. 2(a), the die shape changes when a lamination(s) bends elastically resulting in dimensional changes to the parts formed. For this reason, it is important to investigate the elastic bending and buckling behavior of a clamped lamination subjected to typical forming loads.

Excessive deformation of any of the clamped die laminations beyond a certain maximum value, i.e., $\delta > \delta_{max}$, is considered a die failure. Ideally a PEL die will emulate a continuous die that has negligible surface elastic deformation during forming (e.g. 0.01 mm for a steel die). However, a more practical design requirement for PEL dies is to make sure that the geometrical form of the stamped part is within the specified tolerances. The maximum deformation value (δ_{max}) of a die lamination is explicitly determined from this requirement.

As illustrated in Fig. 2, a group of die laminations deflecting due to high forming loads can be roughly modeled as cantilevered Euler beams in a parallel configuration. The assumption that the frictional shear forces at the interfaces between adjacent laminations are negligible is a worst-case scenario, i.e., conservative design practice. Based on simple beam bending theory, the spring rate k_L of a single protruding die lamination (shown in Fig. 3(a)) in the bending (horizontal) direction is

$$k_L = \frac{F_{bending}}{\delta} = \frac{b \cdot E}{4} \left(\frac{t_L}{a} \right)^3 \quad (1)$$

where:

- a = lamination height
- b = lamination width
- t_L = lamination thickness
- E = tensile elastic modulus of the lamination material
- $F_{bending}$ = horizontal component of the lamination's total forming load.

The effective stiffness $k_{L,eff}$ of the die lamination array in this parallel configuration (see Fig. 2(b)) is simply the sum of all the individual lamination stiffnesses, i.e., $(k_{L1} + k_{L2} + k_{L3} + \dots)$.

The mode of mechanical failure of a lamination from the vertical component of the forming load $F_{buckling}$ will be some form of buckling behavior. As stated by Timoshenko (1961), "in the calculation of critical values of forces applied to the middle plane of a plate at which the flat form of equilibrium becomes unstable and the plate begins to buckle, the same meth-

Table 1 Comparison of the laminated die constructions

Stack of Contoured Laminations	Array of Profiled-Edge Laminations
Difficult to automate the handling of laminations during cutting.	Laminations can slide past the profiled-edge cutting means since only top edge is cut.
Difficult to register laminations during die assembly.	Laminations are easily registered with a base plate and an edge guide.
Difficult to secure lamination stack into a rigid tool.	Lamination only needs to be clamped from the side.
Typically, laminations need to be permanently secured. Reshaping of die surface requires CNC-machining.	Unclamped laminations can be individually recut to new die shape.

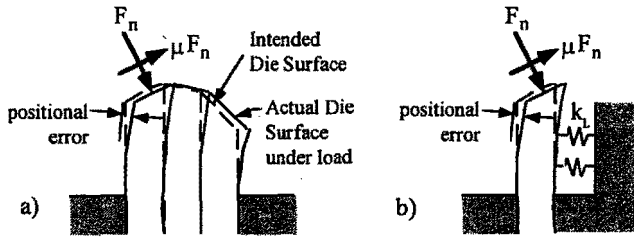

Fig. 2 (a) Group of die laminations subjected to generic forming loads and (b) modeled as cantilevered Euler beams in a parallel configuration

ods as in the case of compressed bars can be used.” Therefore, the critical buckling load $F_{b,critical}$ for the single lamination shown in Fig. 3(a) can be estimated using the Euler column buckling formula

$$F_{b,critical} = \frac{k \cdot E \cdot b \cdot t_L^3}{12 \cdot a^2} \quad (2)$$

where:

k = factor that depends on the end support conditions of the lamination. If the lamination can be modeled as a simple cantilever beam then $k = 2.47$. If the movement of its upper edge is restricted horizontally then $k = 20.2$.

The forming forces on a lamination consist of an effective normal load F_n and a perpendicular frictional load $\mu \cdot F_n$ at the lamination (die) and sheet metal interface where μ is the static frictional coefficient between the die surface and the sheet metal part. These loads are shown in Fig. 2. The total forming load F_T has a magnitude of $F_n \cdot (1 + \mu^2)^{1/2}$. As shown in Fig. 3(b) (vector diagram), F_T typically points inward to the die. This is an advantageous situation since convex portions of the laminated die will tend to be pushed together during forming. In terms of F_T , the $F_{bending}$ and $F_{buckling}$ are $F_T \cdot \sin(\alpha - \tan^{-1} \mu)$ and $F_T \cdot \cos(\alpha - \tan^{-1} \mu)$, respectively.

3 Creating Machining Instructions for Die Laminations

The forming surface of a PEL die is typically defined by a 3-dimensional CAD surface model. The machining instructions for each PEL die lamination are created using this CAD model. As shown in Fig. 4(a), the intersection of a CAD surface model and a $Y-Z$ cutting plane, situated at some point on the X -axis, is a 2-dimensional curve. Phillips and Odell (1984) and Bobrow (1985) have developed algorithms for determining the intersection of two arbitrary surfaces (analytic or parametric). Furthermore, if the $Y-Z$ plane is repositioned along the X -axis by a

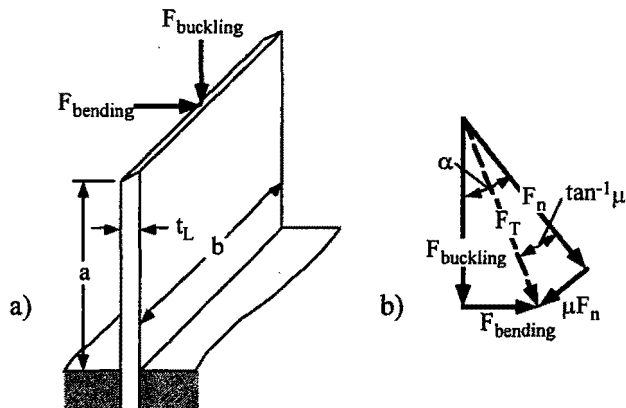

Fig. 3 (a) Single rectangular die lamination subjected to bending and buckling loads and (b) a vector diagram of all forming loads

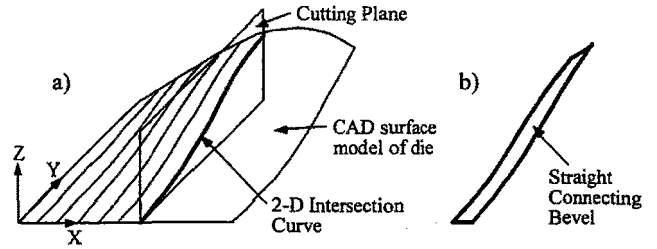

Fig. 4 (a) Surface model of the die's forming surface showing intersection curves and (b) straight connecting bevel between two adjacent curves

constant increment, e.g., 1 mm, the collection of curves produced by each of the same plane/surface intersections will approximate the shape of the original 3-D surface. Figure 4(b) shows how the true 3-D surface between two adjacent curves can be approximated by connecting them with a bevel, i.e. tangential cut that approximates the edge surface with a first-order interpolation of the surface. This connecting bevel eliminates the stair-stepping characteristic of dies made by other methods and constitutes the profiled top edge of each die lamination. Note that the approximation of the 3-D surface gets better as the curves get closer together, i.e. as the x -increment decreases. This collection of curves serves as the machining database for creating a PEL die with the desired forming surface.

Any one of several cutting methods (e.g., laser cutting, machining, abrasive waterjet cutting, plasma-arc cutting) can be used to create the profiled and beveled top edges of each die lamination. These cutting methods are discussed in more detail later in this paper. For whatever method is used, the data needed for cutting a profiled top edge is a series of position/directional vector pairs (P_1, V) as shown in Fig. 5(a). Position point $P_1 = (x_1, y_1, z_1)$ lies on the nearside curve of a die lamination. The unit directional vector $V = V_1 \cdot i + V_2 \cdot j + V_3 \cdot k$, or just written as (V_1, V_2, V_3) is defined by P_1 and $P_2 = (x_2, y_2, z_2)$ according to the following equations:

$$V_1 = \frac{x_2 - x_1}{|\vec{V}|} = \frac{t_L}{|\vec{V}|}, \quad V_2 = \frac{y_2 - y_1}{|\vec{V}|}$$

$$\text{and } V_3 = \frac{z_2 - z_1}{|\vec{V}|} \quad (3)$$

where:

$$|\vec{V}| = [t_L^2 + (y_2 - y_1)^2 + (z_2 - z_1)^2]^{1/2}$$

Point P_1 is easy to determine because x_1 and y_1 will be prescribed and z_1 is explicitly defined by the nearside intersection curve. Point P_2 is harder to define because there is no particular one associated with the defined point P_1 . To determine P_2 , Zheng et al. (1996) have developed an algorithm for creating kinematically and dynamically desirable cutting trajectories for a laser,

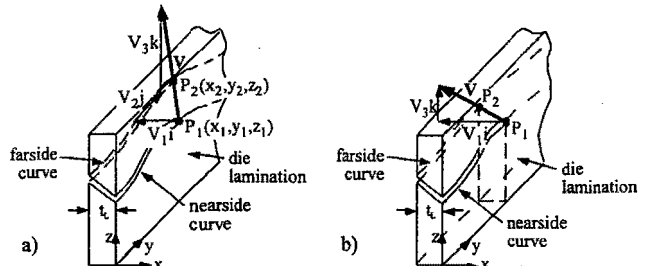

Fig. 5 Die lamination with an (a) compound bevel and (b) simple planar bevel

i.e. the optimal P_2 for each P_1 , for curves consisting of polylines (typical output from an SLA part file). When P_2 is determined then the bevel cutting head only requires translation along the Y and Z -axes (x -position is kept constant) and rotation about the two orthogonal axes.

Constraining Lamination Cutter to Planar Beveling. There are many forming dies used in industry for such processes as stretch-forming and rubberforming that have only mild curvatures and low draws. For these types of die shapes, reasonable die shape fidelity, i.e. small deviations of the machined shape from the desired CAD shape, can be achieved even if the bevel cutting head is only allowed to rotate about the Y -axis. This will allow for simple planar beveling, as shown in Fig. 5(b), but not compound 3-D beveling like that shown in Fig. 5(a). In this case, $y_1 = y_2$ for position points P_1 and P_2 , and the orientation vector $\vec{V} = (V_1, 0, V_3)$.

Geometric Error Introduced by Straight Bevel Approximation. For the two XZ -plane cross sections of a die lamination shown in Fig. 6, it is evident that the straight bevel of the profiled edge will deviate from the desired die surface. During the grinding and polishing operations on the die surface, this deviation or shape error is increased for convex cross-sectional profiles, as shown in Fig. 6(a), because of material removal. For the same reason, i.e. material removal, the shape error is decreased for concave cross-sectional profiles as shown in Fig. 6(b). Therefore, the extent of material removal during the smoothing operation directly affects the shape integrity of the forming die.

4 Bevel Cutting Methods for Die Laminations

After the cutting trajectories, i.e., array of (P_i, \vec{V}) , for each profiled top edge are determined, then the die laminations are ready for processing. Either new die lamination blanks can be cut or existing laminations can be recut into a new shape. Machining bevels into the die lamination edge can be accomplished by several methods. The flute-edge of a standard endmill mounted in the spindle of a 4 or 5-axis (X , Y , and Z -translation, Y and Z -rotation) CNC milling center can be used to cut bevels into a suitably-fixed die lamination. The weaving-type motion of a ball endmill from a 3-axis (X , Y , Z translation) CNC machining center can also cut bevels. Both machining methods rely on the application of high machining forces to remove the unwanted material from the workpiece. To minimize the amount of material removed while cutting the bevel, a very narrow kerf can be cut into the die lamination using traveling wire-EDM, abrasive water-jet cutting, plasma-arc cutting, or laser cutting (both CO_2 and $Nd:YAG$). Each of these methods require CNC-controlled axes that move in X , Y , Z translation, and Y , Z rotation.

The important characteristics of any bevel cutting method are the maximum achievable bevel angle, maximum cutting speed,

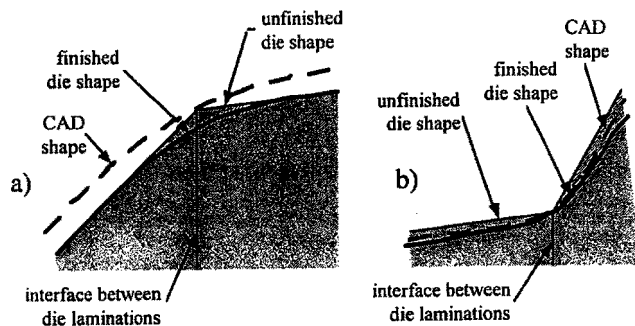

Fig. 6 Shape error due to smoothing (a) convex and (b) concave die geometries

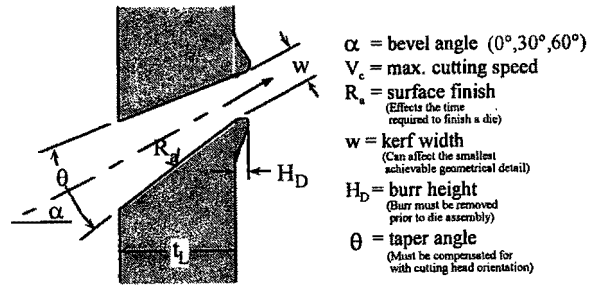

Fig. 7 Quality characteristics of a bevel cut

cut surface quality, cutting accuracy, amount of material removed, effect of material hardness on speed, tool wear, extent of metal burring, and machinery cost. Cutting bevels with a weaving ball endmill is an impractical cutting method primarily because of the short tool life, workpiece deflection, the detrimental effect material hardness has on cutting speed, slow cutting speeds in general and extensive edge burring. Furthermore, the traveling wire EDM machine system yields a cut of excellent quality and accuracy but the extremely slow cutting speed is considered unacceptable for this application.

The bevel cutting methods left are machining with the flute-edge of an endmill, abrasive water jet cutting, plasma-arc cutting, and laser cutting. Each of these methods were investigated in detail through a series of bevel cutting experiments to determine how rapidly and accurately they will machine steel PEL laminations. Comparisons between various cutting methods discussed in this section are based on cutting trials with 1.47 mm thick SAE 1010 cold-rolled steel laminations. According to Semiatin (1988), steel is arguably the most commonly die material used in industry. As seen in Fig. 7, the basis of evaluation for each beveling method will be the quality characteristics of the bevel cut that it makes.

Machining with the Flute-Edge of an Endmill. As seen in Fig. 8(a), the profiled-edge of a die lamination can be machined using the flute-edge of an endmill in a 4-axis machining center for planar bevels (see Fig. 5(b)) or a 5-axis version for compound bevels (see Fig. 5(a)). Cutting bevels with this method requires a significant amount of material removal, i.e., the diameter D of the endmill, as shown in Fig. 8(b). Based on the geometry of the endmill and the tilted lamination (see Fig. 8(c)), the maximum edge bevel angle α that can be machined is

$$\alpha = \cos^{-1} \left(\frac{t_L}{L_f} \right) \quad (4)$$

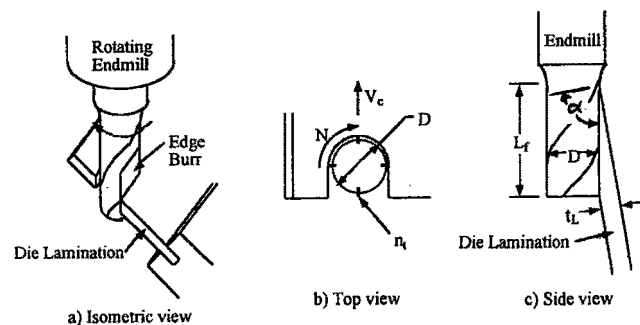

Fig. 8 Machining a lamination bevel with the flute-edge of an endmill

Table 2 Experimental results for flute-edge endmilling of bevels

α	0°	30°	60°
Ave. R_a (μm)	1.3	4.6	3.1
Ave. H_D (mm)	0.3	2.7	8.6
Max. V_c (m/min)	0.46	0.46	0.25

where:

L_f = length of the cutting flute.

For cutting experiments involving fixed bevel angles of 0°, 30° and 60° (also used for AWJ and laser cutting experiments), cutting speeds (V_c) were varied between 0.102 and 0.305 m/min., spindle speed (N) between 1000 and 3000 RPM, and coolant flow either on or off. A 6.4 mm diameter, 4-fluted ($n = 4$) carbide endmill mounted in the spindle of a Cincinnati-Milacron™ 3-axis machining center was used to cut the laminations. According to the experimental results (see Table 2 for average values), beveling the 1.47 mm thick steel laminations with an endmill's flute-edge leaves a very good surface finish at reasonable cutting speeds. However, slower cutting speeds and higher spindle speeds yield the best surface finish and the smallest burr. The maximum V_c and N for machining bevels is highly dependent on the material's machinability. Coolant should be used when cutting metal to extend the life of the tool and to minimize the Heat Affected Zone (HAZ) of the cut. The extent of burring on the climb-milling side of the cut is extensive and it gets longer as the bevel angle increases. Due to the high cutting forces from the large amount of material that is removed there is also significant deflection of the lamination during machining which undoubtedly exacerbates any chattering problems and increases the machining inaccuracy.

Abrasive Water Jet (AWJ) Cutting. As shown in Fig. 9, Abrasive Water Jet (AWJ) cutting is a very good non-contact method for making narrow bevel cuts into die laminations. This method has been used in industry for cutting metal since 1982 (Tikhomirov, 1992). Because it is non-contact and low forces are imposed on cutting area, there is negligible deflection of the lamination during cutting. An OMAX™ JetMachining System was used for the AWJ cutting experiments with V_c and upstream water pressure P_w varied between 0.10 and 0.26 m/min, and 210 and 280 MPa, respectively. Aside from a decrease in the maximum cutting speed, AWJ cutting seems to have no problems with high bevel angles. According to Tikhomirov (1992), the maximum cutting speed for this process is highly dependent on the yield strength of the material. However, the experimentally measured V_c for 1.47 mm thick mild steel sheet and harder tool steel sheet were similar in magnitude. The sur-

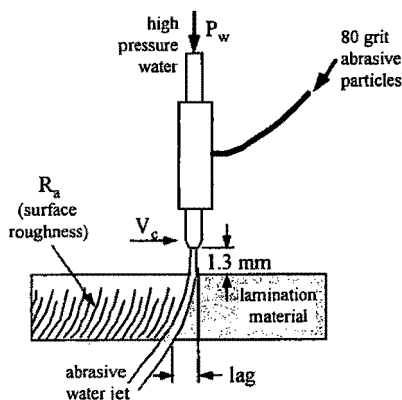

Fig. 9 Abrasive water jet cutting

face finish of the bevel cut is slightly rougher than flute-edge endmilling but much more consistent when process parameters are changed. The burr left on the far edge of the kerf is much less than CNC-machining with an endmill, especially at high bevel angles. However, the kerf made with AWJ has a large taper, around 10 deg for all the bevel angles tested. The kerf taper angle may decrease when thicker laminations are cut and if P_w is increased. Average values of various quality characteristics from the AWJ experimental bevel cuts are listed in Table 3.

Even though the cut from an abrasive waterjet introduces error in the cut because of the drag line, taper angle of the kerf, and variable kerf width, Matsui (1991) has successfully compensated for these deterministic errors as shown in Fig. 10 thereby increasing the precision of the AWJ process. Compensation for these errors involves offsetting the centerline of the kerf by half of its width ($w/2$), rotating the cutting nozzle slightly about the direction of travel (y -axis) by half the taper angle ($\theta/2$), and tilting the cutting head backwards (about x -axis) to minimize the effect of the lag line. If these errors are deterministic then the appropriate geometrical compensation can be programmed into the cutting trajectory.

Plasma-Arc Cutting. Using a plasma-arc is another non-contact cutting method that can be used to cut bevels into die laminations. The system used for the bevel cutting experiments was a Hypertherm™ HD-1070 HyDefinition Plasma unit. The attractive feature of plasma-arc cutting is the allowable cutting speeds that are typically 5 to 10 times faster than machining and abrasive water-jet cutting. Unfortunately the problems of excessive kerf taper and the tendency of kerf edge nearest to the cutting nozzle to experience self-burning make plasma-arc cutting unsuitable for cutting lamination bevels. The key to plasma-arc's successful usage in cutting bevels will be to solve the edge burning problem, minimize or even eliminate (if possible) the kerf taper, and to reduce the amount of edge dress.

Laser Cutting. Laser cutting, as illustrated in Fig. 11(a), is another promising non-contact method for machining bevels because of the rapid cutting speeds and steep bevel angles that can be achieved. The first issue to be resolved is what configuration of laser type (CO_2 or Nd:YAG), beam temporal mode (pulsed or CW), beam delivery system (hard-optics or fiber-optics) and type of cutting gas (N_2 for fusion cutting and O_2 for reactive gas cutting) is best for cutting lamination bevels, particularly in steel. Because literature on laser bevel cutting is limited, a series of experiments were performed to determine the maximum bevel angle and cutting speeds for various laser configurations. The best configuration for cutting steep bevel angles (at least up to 80 deg) was found to be a pulsed Nd:YAG laser with hard-optic beam delivery and O_2 cutting gas. All other configurations were only capable of making suitable bevel cuts (e.g., undistorted edges) up to a maximum angle of 30 deg.

According to DiPietro (1994), the easily measurable output responses that help to define the kerf quality of the laser cut bevel are the kerf width w , surface roughness of the kerf R_a , the height of the burr H_D on the farside of the cut, and taper angle θ as shown in Figs. 7 and 11(b). A narrow kerf width is desirable so that fine details can be cut into the lamination edge instead of the wide cut characteristic of conventional ma-

Table 3 Experimental results for AWJ bevel cutting of steel

α	0°	30°	60°
Ave. R_a (μm)	4.8	5.1	4.3
Ave. w (mm)	0.62	0.63	0.80
Ave. H_D (mm)	0.061	0.100	0.053
effective thickness of material being cut (mm)	1.47	1.70	2.95
Max. V_c (m/min)	0.34	0.31	0.20
kerf taper	10°	11.5°	9°

ining methods (e.g. flute-edge endmilling). A low surface roughness of the cut surface is desirable since it will decrease the grinding and polishing time of the assembled PEL die forming surface. Minimal or no dross on the farside of the kerf is desirable since any dross must be removed before the die laminations can be assembled into a complete die, thereby increasing the overall fabrication time. A negligible taper angle is desirable since little or no geometrical compensation will be required.

The control factors that affect these output responses are the process lens focal length F which is proportional to the focused spot diameter d , pulse width τ_w , pulsing frequency f_p , cutting speed V_c , type of assist gas (e.g. O_2 , Air, N_2), and assist gas pressure P_g . All of these control factors were easily varied with the Laserdyne™ 5-axis model 780 CNC laser cutting system (Lumonics JK704 laser) used for a Taguchi-style experimental design. Since almost all Nd:YAG lasers used for cutting have a tuned resonator, the output power of the laser beam is held constant to minimize the beam divergence (Chryssolouris, 1991). Therefore, the average laser output power is consistently held close to 0.25 kW for these experiments.

Optimal Parameters. For the smoothest surface finish, a low percent O_2 , medium f_p , and high τ_w were shown to work best. For the narrowest kerf, a low percent O_2 , high f_p , and low F are recommended. Depending upon what surface qualities of the bevel cut are most important, the levels of each laser cutting parameter can be set accordingly. The test bevel cuts with the best overall kerf quality for each bevel angle and the associated process parameters are listed in Table 4.

By using optimized process parameters, lamination bevel cuts can have the same general surface finish R_a as flute-edge endmilling and AWJ cutting. However, R_a deteriorates significantly with an increase in the bevel angle. The edge-burring due to adherent dross is comparable to AWJ but much less than endmilling. The kerf width is the smallest of all three bevel cutting methods. Although bevels up to ± 80 deg are possible, the range of parameters that yields acceptable cuts narrows with the increase in bevel angle. Since there is a very small mechanical force associated with laser cutting, the fixturing required for lamination being cut is minimal. Furthermore, the HAZ of the laser cut is very small and most of the heat-affected material is blown away during the cutting process.

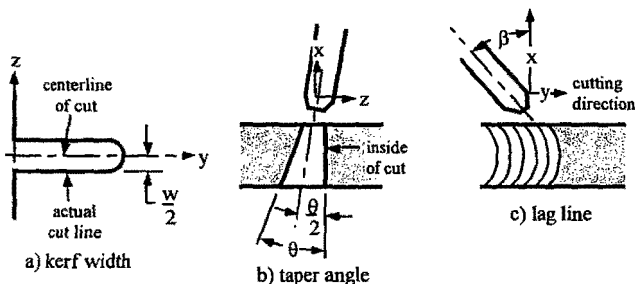

Fig. 10 Compensation methods for AWJ cutting error

Summary of Bevel Cutting Methods. As a final comparison of the three candidate bevel cutting methods, the beveling performance measures (i.e. cutting force, maximum V_c , maximum α , taper angle, kerf width, machining burr height, and kerf surface finish) of each method, with process parameters set to their optimal levels, are listed in Table 5. The w , H_D , and R_a measurements listed in the table are for a 30 deg bevel only. By considering the results of all the bevel cutting experiments, the following comparisons can be made:

- Flute-edge endmilling involves the application of a high cutting force with a cutting tool to remove the unwanted lamination material. The higher cutting forces significantly deflect the cantilevered portion of a lamination being beveled. AWJ cutting and laser cutting, i.e. non-contact cutting methods, cause negligible deflection to the lamination.
- All three cutting methods are capable of high cutting speeds but the maximum speed is highly dependent upon the material composition and hardness with flute-edge endmilling and AWJ cutting. The maximum V_c for the laser is only dependent on laser power, i.e. proportional to q_{laser} , which means that higher cutting rates are achievable.
- The maximum bevel angle for all three methods is around ± 80 deg.
- The kerf from AWJ cutting has a very large, consistent taper of around 10 deg for all bevel angles that must be compensated for during bevel cutting. Laser cutting creates only a slight kerf taper. Flute-edge endmilling leaves no appreciable kerf taper unless there is significant deflection of the lamination and cutting tool during beveling.
- The width of the kerf affects the smallest radius of curvature achievable for a lamination's profiled edge. Of the three beveling methods, laser cutting creates the narrowest kerf. The kerf from AWJ cutting is also narrow but not as much as that cut with a laser. The kerf width from endmilling is the diameter of the cutting tool.
- Flute-edge endmilling leaves a very large machining burr, especially at larger bevel angles. AWJ cutting and laser cutting, on the other hand, yield much smaller machining burrs. Laser cutting with a pure oxygen assist gas yields

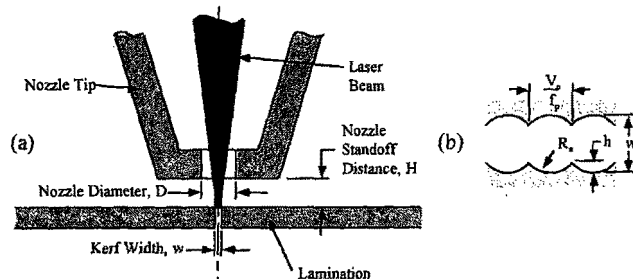

Fig. 11 Geometry of the (a) laser cutting nozzle and (b) cut from a pulsed Nd:YAG laser

Table 4 Optimal control factor levels for an Nd:YAG laser cutter

α	Control Factor Levels						Output Responses		
	%O ₂ (by mass)	P _g (kPa)	F (cm)	f _p (Hz)	V _c (m/min)	τ_w (msec)	R _a (μ m)	w (mm)	H _D (mm)
0°	100	410	7.6	100	0.25	0.5	2.6	0.14	0.02
30°	100	280	7.6	100	0.25	0.5	4.4	0.10	0.04
60°	62	280	20.3	30	0.13	0.4	5.9	0.07	0.39

a porous, brittle edge burr (i.e. iron oxide) which is easily removed from the cut lamination without the need for grinding.

- Flute-edge endmilling yields the smoothest surface finish of all the methods although the finish deteriorates at higher bevel angles from more machining chatter. A similar effect is noticed with laser cutting. AWJ cutting offers the most consistent surface finish for all bevel angles.

Based on the preceding analysis and discussion, the authors rank the suitability (best to worst) of these three bevel cutting methods for cutting steel laminations as follows:

1. Nd:YAG laser cutting because V_c is only dependent on laser power, tool wear is nonexistent, cutting force is negligible and the kerf is the narrowest of all,
2. Abrasive water jet cutting since V_c is dependent on material hardness and the kerf taper is the largest among the three methods, and
3. Flute-edge endmilling since the cutting force, kerf width, edge burr, and V_c's dependency on material hardness is the greatest overall.

5 Machinery for Fabricating PEL Dies

As with CNC-machining a sheet metal forming die, the two most important specifications of equipment used to fabricate PEL dies are to 1) get as close to near net shape as possible thereby minimizing the need for a post-grinding or finishing operation and 2) accomplish this task as fast as possible. The key to meeting these specifications are the correct choice of a bevel cutting method, as discussed in the previous section, and the efficient handling of die laminations during the cutting. In this section, commercially-available machinery for cutting PEL die laminations will be described.

For compound beveling of PEL die laminations, a 5-axis machining center (e.g. 3 translational & 2 rotational axes) is required to correctly position the cutting nozzle during the profiling process. There are numerous 5-axis conventional machining centers, a few laser machining centers and at least two AWJ

cutting centers currently available that can be used to machine compound bevels. Using either conventional, laser and AWJ machining centers, a die lamination blank is first secured vertically to the machine workbed and then the profiled-edge is machined. The die lamination can be handled manually or the machining center can be retrofitted with an automatic handling mechanism.

Five-axis laser machining centers are much more expensive than comparable AWJ or CNC machines. For example, a Laserdyne Model 780 BeamDirector™ 5-Axis laser machining center with a Lumonics JK704 laser currently sells for around \$625K. Other laser machining centers vary in price from \$500K to \$700K. In contrast, a Cincinnati-Milacron Sabre-1000 CNC 3-axis vertical machining center retrofitted with a Tsudakoma TTNC-201 tilting rotary table that has a similar work volume as the Laserdyne system sells for around \$120K. For \$180K, a company can purchase a Jet Edge® model 55-30 AWJ cutting system that's mounted to a 5-axis, robot-controlled gantry table and has a similar work volume as the laser system. With any of these systems, the estimated cost of a custom-built lamination handling mechanism has not been added to their overall cost.

Both conventional CNC and laser machining centers are designed for general industrial use and not optimized for cutting die laminations in terms of speed, cost, and factory floor space required. Taking into account the high cost of commercially available equipment and the added cost of a custom-built lamination handling mechanism, a dedicated stand-alone machine for fabricating PEL dies is proposed by the author as cost-effective alternative to retrofitting currently-available 4 and 5-axis cutting machines.

6 General Procedure for Designing and Fabricating PEL Dies

As a summary of the preceding sections, the general procedure for designing and fabricating a PEL forming die will be discussed.

1. Considering the sheet metal part being formed and its expected production quantity, choose an appropriate die

Table 5 Comparison table of bevel cutting methods using optimal parameter settings

Cutting Method	Flute-Edge Endmilling	Abrasive Water Jet Cutting	Nd:YAG Laser Cutting with Hard Optic Beam Delivery
Cutting Force	Significant (lamination bends 1-2 mm at high bevel angles)	Small (momentum transfer from abrasive)	Negligible
Maximum V _c for 0° bevel cut (meters/min)	0.46 (affected by material hardness and composition)	0.31 (affected by material composition)	0.44 for q _{laser} =0.3 kW (max. V _c ∝q _{laser} [Powell,1993])
Maximum α	85°	at least 75°	80°
Kerf Taper Angle θ	None	-10°	+1° to +2°
30° Bevel Cut	w (mm)	6.4 (tool \varnothing)	0.1
	H _D (mm)	2.8	0.04 (porous edge burr)
	R _a (μ m)	0.7	3.4

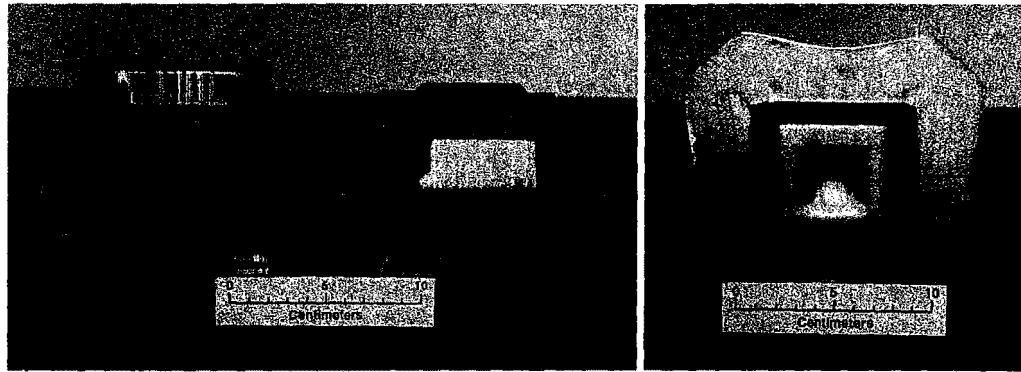

Fig. 14 (a) Matched set of PEL stamping dies and (b) sheet metal part stamped with these dies

machining center. Special fixturing was required to minimize lamination deflection during machining.

The die laminations as seen in Fig. 13(a) were finally mounted and clamped into a rigid frame to form the complete PEL die. As shown in Fig. 13(b), the frame consists of an L-shaped steel base, a lamination edge guide secured to the base, and a steel movable clamping wall which is rigidly bolted to the base after the laminations are clamped. The die surface was then ground and polished for the remaining stamping trials. The assembled dies, as shown in 14(a), can be mounted and used in any type of stamping press. A 0.64 mm thick sheet metal part successfully stamped with these dies is shown in Fig. 14(b).

8 Conclusions

The PEL tooling method offers advantages over other lamination-based methods for fabricating sheet metal forming dies. Individual PEL laminations in a clamped array have the propensity to bend or buckle under high forming loads but these effects can be predicted and then dealt with using design modifications. The machining instructions for the PEL's top edge are discussed for general 3-D die shapes (requiring complex bevels) and for simpler shapes (only requiring planar bevels). Cutting bevels into laminations is best done by laser cutting, AWJ cutting and flute-edge endmilling primarily because of speed and accuracy issues. The machinery for fabricating PEL dies is discussed and the design of a dedicated machine is suggested. Finally, the general procedure for designing a PEL die is applied to a matched set of sheet metal forming dies. These dies are used to successfully stamp sheet metal parts.

9 Acknowledgment

The authors would like to acknowledge support of the National Science Foundation under grant no. DDM-9202362.

References

- Berry, H. D., "Intricate Shapes Built Up From Stacked Stampings," *Iron Age*, Vol. 128, No. 26, Dec. 29, 1966, pp. 44-45.
- Bobrow, J. E., "NC Machine Tool Path Generation from CSG Part Representations," *Computer-Aided Design*, Vol. 17, No. 2, March, 1985, pp. 69-76.
- Chryssolouris, G., *Laser Machining: Theory and Practice*, Springer-Verlag, Inc., New York, 1991.
- Clevenger, W. S., Cohen, J. S., and Cohen, S. G., "Laminated Die Form and Method of Producing Same," *U.S. Patent No. 2679172*, Issued May 25, 1954.
- Dickens, P., Simon, D., and Sketch, R., "Laminated Tooling for Moulding Polyurethane Parts," *Proceedings from the Rapid Prototyping and Manufacturing Conference*, Dearborn, Michigan, April 22-25, 1996.
- DiMatteo, P. L., "Method of Generating and Constructing Three-Dimensional Bodies," *U.S. Patent No. 3932923*, Issued January 20, 1976.
- DiPietro, P., and Yao, Y. L., "An Investigation Into Characterizing and Optimizing Laser Cutting Quality—A Review," *International Journal of Machine Tools and Manufacturing*, Vol. 34, No. 2, 1994, pp. 225-243.
- Glozer, G. R., and Brevick, J. R., "Laminate Tooling for Injection Moulding," *Proceedings of the Institute of Mechanical Engineers Part B: Journal of Engineering Manufacture*, Vol. 207, July, 1993, pp. 9-15.
- Hart, F. V., "Mold and Mold Making Method," *U.S. Patent No. 2274060*, Issued Feb. 24, 1942.
- Kunieda, M., and Nakagawa, T., "Manufacturing of Laminated Deep Drawing Dies by Laser Beam Cutting," *Proceedings of the 1st International Conference on Technology of Plasticity*, Vol. 1, Tokyo, Japan, 1984, pp. 520-525.
- Matsui, S., Matsumura, H., Ikemoto, Y., and Shimizu, H., "High Precision Cutting Method for Metallic Materials by Abrasive Waterjet," *Proceedings of the 6th American Water Jet Conference*, Houston, TX, August 24-27, 1991, pp. 127-137.
- Nakagawa, T., Kunieda, M., and Liu, S. D., "Laser Cut Sheet Laminated Forming Dies by Diffusion Bonding," *Proceedings of the 25th International Machine Tool Design and Research Conference*, U. of Birmingham, England, April 22-24, 1985, pp. 505-510.
- Phillips, M. B., and Odell, G. M., "An Algorithm for Locating and Displaying the Intersection of Two Arbitrary Surfaces," *IEEE Computer Graphics and Applications*, Vol. 4, No. 9, Sept., 1984.
- Pridham, M. S., and Thomson, G., "Part Fabrication Using Laser Machining and Welding," *Proceedings of the 1993 Solid Freeform Fabrication Conference*, Austin, TX., Aug. 1993, pp. 74-80.
- Semiatin, S. L., et al., *Metals Handbook: Volume 14, Forming and Forging*, Ninth Edition, ASM International, Metals Park, Ohio, 1988.
- Tikhomirov, R. A., Babanin, V. F., Petukhov, E. N., Starikov, I. D., and Kovalev, V. A., *High-Pressure Jetcutting*, ASME Press, New York, 1992.
- Timoshenko, S. P., and Gere, J. M., *Theory of Elastic Stability*, McGraw-Hill Book Co., New York, 1961.
- Walczyk, D. F., and Hardt, D. E., "A New Rapid Tooling Method for Sheet Metal Forming Dies," *Proceedings of the 5th International Conference on Rapid Prototyping*, Dayton, OH, June 12-15, 1994.
- Weaver, W. R., "Process for the Manufacture of Laminated Tooling," *U.S. Patent No. 5031483*, Issued July 16, 1991.
- Zheng, Y., Choi, S., Mathewson, B., and Newman, W., "Progress in Computer-Aided Manufacturing of Laminated Engineering Materials Utilizing Thick, Tangent-Cut Layers," *Proceedings of the Seventh Solid Freeform Fabrication Symposium*, University of Texas at Austin, Austin, TX, August 12-14, 1996, pp. 344-351.