

Lectures on  
PROBABILISTIC LOGICS AND THE SYNTHESIS OF RELIABLE  
ORGANISMS FROM UNRELIABLE COMPONENTS

delivered by

PROFESSOR J. von NEUMANN

The Institute for Advanced Study  
Princeton, N. J.

at the

CALIFORNIA INSTITUTE OF TECHNOLOGY

January 4-15, 1952

Notes by

R. S. PIERCE

## Publication Chronology for von Neumann's

 PROBABILISTIC LOGICS AND THE SYNTHESIS OF RELIABLE  
 ORGANISMS FROM UNRELIABLE COMPONENTS
 

---

The following lists the versions of the von Neumann lectures that exist at Caltech or that have been published. There are 2 versions at Caltech and 3 published versions. It appears that the most nearly correct version is the first Caltech version [1] (See References, p. iii). Quite a few errors were introduced when the version for [3] was prepared. It appears that this second version was intended as an “improved” version for publication. All three of the published versions appear to be based on the first publication ([3]).

Significant features of the versions include:

- [1] This typescript, with the math drawn by hand, is the only version that includes the “Analytical Table of Contents.”
- [2] This is a Caltech copy of the published version [3]. It is available online at: <http://www.dna.caltech.edu/courses/cs191/paperscs191/VonNeumann56.pdf>.  
This version also includes a few handwritten notes. It is likely that it was marked up at Caltech sometime after 1956. The handwritten text is not included in the published versions. (The URL is from within the Course Notes for BE/CS/CNS/Bi 191ab taught by Eric Winfree, 2nd and third terms, 2010, URL: <http://www.dna.caltech.edu/courses/cs191/>)
- [3] Publication in Automata Studies. The text is somewhat different from [1], possibly edited by von Neumann. It is still a typescript, but with typewriter set mathematics. (Likely using a new IBM math-capable typewriter.) The Figures were redrawn. These Figures are cleaner, but a number of errors were introduced. Specifically, Figure 4 is in error: the right-hand circuit should have threshold 2. Figure 9 has no outputs shown. Figure 11 has an incorrect cross-over in the  $a^{-1}$  circuit. Figure 27 has an incorrect point label ( $\epsilon_0$ ) on x-axis. Figure 28 has an incorrect label on the right side of the left-hand figure ( $\rho$  instead of  $Q$ ). Figure 33 has the upper right corner missing. Figure 38 is missing tick marks for  $\alpha_o$ . Figure 44 is missing ( $\nu = 3$ ) on y-axis. This version is still a typescript, but was re-typed using a typewriter that provided math symbols, but not calligraphic letters.
- [4] This version is based on [3], but was reset in type. It uses the same Figures as [3].
- [5] This version is from [4] without resetting the type. Someone made several hand corrections to the Figures (including some of the errors noted above). It is possible that they had access to [1]. Of the three published versions, [5] appears to be the most nearly correct.

The version that follows here is based on the original version [1], with additional checking of subsequent versions for useful changes or corrections. The text has been converted to  $\text{\TeX}$  but the Figures are, at present, scanned from the original [1].

---

References

---

- [1] J. von Neumann, “PROBABILISTIC LOGICS AND THE SYNTHESIS OF RELIABLE ORGANISMS FROM UNRELIABLE COMPONENTS,” lectures delivered at the California Institute of Technology, January 4-15, 1952. Notes by R. S. Pierce, Caltech Eng. Library, QA.267.V6
- [2] J. von Neumann, “PROBABILISTIC LOGICS AND THE SYNTHESIS OF RELIABLE ORGANISMS FROM UNRELIABLE COMPONENTS,” with the annotation hand-written on the cover page: “Automata Studies, ed C. Shannon, 1956, Princeton Univ Press.”
- [3] Published in *Automata Studies*, eds. C. E. Shannon and J. McCarthy, Princeton University Press, *Annals of Mathematics Studies*, No. 34, pp. 43-98, 1956.
- [4] Published in *John Von Neumann, Collected Works*, Vol. 5, ed. A. H. Taub, Pergamon Press, pp. 329–378, 1963.
- [5] Published in the *Babbage Series on the History of Computing*, vol. 12, Ch. 13. pp. 553–603.

Michael D. Godfrey  
Stanford University

June 2010



## ANALYTICAL TABLE OF CONTENTS

	Page
<b>1</b> Introduction. ....	1
<b>2</b> A schematic view of automata. ....	2
2.1 Logics and automata. ....	2
2.2 Definitions of the fundamental concepts. ....	2
2.3 Some basic organs. ....	4
<b>3</b> Automata and the propositional calculus. ....	5
3.1 The propositional calculus. ....	5
3.2 Propositions, automata and delays. ....	6
3.3 Universality. General logical considerations. ....	7
<b>4</b> Basic organs. ....	9
4.1 Reduction of the basic components. ....	9
4.1.1 The simplest reductions. ....	9
4.1.2 The double line trick. ....	9
4.2 Single basic organs. ....	12
4.2.1 The Scheffer stroke. ....	12
4.2.2 The majority organ. ....	13
<b>5</b> Logics and information. ....	14
5.1 Intuitionistic logics. ....	14
5.2 Information. ....	15
5.2.1 General observations. ....	15
5.2.2 Examples. ....	15
<b>6</b> Typical syntheses of automata. ....	16
6.1 The memory unit. ....	16
6.2 Scalers. ....	17
6.3 Learning. ....	19
<b>7</b> The role of error. ....	21
7.1 Exemplification with the help of the memory unit. ....	21
7.2 The general definition. ....	22
7.3 An apparent limitation. ....	22
7.4 The multiple line trick. ....	22

<b>8</b>	Control of error in single line automata.....	23
8.1	The simplified probability assumption.....	23
8.2	The majority organ.....	23
8.3	Synthesis of automata.....	24
8.3.1	The heuristic argument.....	24
8.3.2	The rigorous argument.....	26
8.4	Numerical evaluation.....	29
<b>9</b>	The technique of multiplexing.....	30
9.1	General remarks on multiplexing.....	30
9.2	The majority organ.....	30
9.2.1	The basic executive organ.....	30
9.2.2	The need for a restoring organ.....	30
9.2.3	The restoring organ.....	31
9.2.3.1	Construction.....	31
9.2.3.2	Numerical evaluation.....	32
9.3	Other basic organs.....	33
9.4	The Scheffer stroke.....	34
9.4.1	The executive organ.....	34
9.4.2	The restoring organ.....	34
<b>10</b>	Error in multiplex systems.....	37
10.1	General remarks.....	37
10.2	The distribution of the response set size.....	38
10.2.1	Exact theory.....	38
10.2.2	Theory with errors.....	40
10.3	The restoring organ.....	41
10.4	Qualitative evaluation of the results.....	42
10.5	Complete quantitative theory.....	42
10.5.1	General results.....	43
10.5.2	Numerical evaluation.....	43
10.5.3	Examples.....	45
10.5.3.1	First example.....	45
10.5.3.2	Second example.....	45
10.6	Conclusions.....	46
10.7	The general scheme of multiplexing.....	46
<b>11</b>	General comments on digitalization and multiplexing.....	47
11.1	Plausibility of various assumptions regarding the digital vs. analog character of the nervous system.....	47
11.2	Remarks concerning the concept of a random permutation.....	48
11.3	Remarks concerning the simplified probability assumption.....	50

<b>12</b>	Analog possibilities.....	50
12.1	Further remarks concerning analog procedures.....	50
12.2	A possible analog procedure.....	51
12.2.1	The set up.....	51
12.2.2	The operations.....	52
12.3	Discussion of the algebraical calculus resulting from the above operations..	52
12.4	Limitations of this system.....	54
12.5	A plausible analog mechanism: Density modulation by fatigue.....	54
12.6	Stabilization of the analog system.....	55
<b>13</b>	Concluding remark.....	57
13.1	A possible neurological interpretation.....	57
	References.....	58





PROBABILISTIC LOGICS AND THE SYNTHESIS OF RELIABLE  
ORGANISMS FROM UNRELIABLE COMPONENTS

By J. von Neumann

## 1. INTRODUCTION

The paper which follows is based on notes taken by R. S. Pierce on five lectures given by the author at the California Institute of Technology in January 1952. They have been revised by the author, but they reflect, apart from stylistic changes, the lectures as they were delivered. The author intends to prepare an expanded version for publication, and the present write up, which is imperfect in various ways, does therefore not represent the final and complete publication. That will be more detailed in several respects, primarily in the mathematical discussions of Sections 9 and 10 (especially in 10.2 (p. 38) and 10.5.2 (p. 43)), and, also in some of the parts dealing with logics and with the synthesis of automata. The neurological connections may then also be explored somewhat further. The present write up is nevertheless presented in this form because the field is in a state of rapid flux, and therefore for ideas that bear on it an exposition without too much delay seems desirable.

The *analytical table of contents* which precedes this will give a reasonably close orientation about the contents – indeed the title should be fairly self explanatory. The subject-matter is the role of error in logics, or in the physical implementation: of logics – in automata-synthesis. Error is viewed, therefore, not as an extraneous and misdirected or misdirecting accident, but as an essential part of the process under consideration – its importance in the synthesis of automata being fully comparable to that one of the factor which is normally considered, the intended and correct logical structure.

Our present treatment of error is unsatisfactory and ad. hoc. It is the author's conviction, voiced over many years, that error should be treated by thermodynamical methods and be the subject of a thermodynamical theory, as information has been by the work of L. Szilard and C. E. Shannon. (Cf. 5.2 (p. 15)). The present treatment falls far short of achieving this, but it assembles, it is hoped, some of the building materials which will have to enter into the final structure.

The author wants to express his thanks to K. A. Brückner and M. Gell-Mann, then at the University of Illinois, to discussions with whom in 1951 he owes some important stimuli on this subject; to R. S. Pierce at the California Institute of Technology, on whose excellent notes this exposition is based; and to the California Institute of Technology whose invitation to deliver these lectures combined with the very warm reception by the audience caused him to write this paper in its present form.

## 2. A SCHEMATIC VIEW OF AUTOMATA

### 2.1 Logics and Automata

It has been pointed out by A. M. Turing [5] in 1937 and by W. S. McCulloch and W. Pitts [2] in 1943 that effectively constructive logics, that is, intuitionistic logics, can be best studied in terms of automata. Thus logical propositions can be represented as electrical networks or (idealized) nervous systems. Whereas logical propositions are built up by combining certain primitive symbols, networks are formed by connecting basic components, such as relays in electrical circuits and neurons in the nervous system. A logical proposition is then represented as a “black box” which has a finite number of inputs (wires or nerve bundles) and a finite number of outputs. The operation performed by the box is determined by the rules defining which inputs, when stimulated, cause responses in what outputs, just as a propositional function is determined by its values for all possible assignments of values to its variables.

There is one important difference between ordinary logic and the automata which represent it. Time never occurs in logic, but every network or nervous system has a definite time lag between the input signal and the output response. A definite temporal sequence is always inherent in the operation of such a real system. This is not entirely a disadvantage. For example, it prevents the occurrence of various kinds of more or less overt vicious circles (related to “non-constructivity,” “impredicativity,” and the like) which represent a major class of dangers in modern logical systems. It should be emphasized again, however, that the representative automaton contains more than the content of the logical proposition which it symbolizes – to be precise, it embodies a definite time lag.

Before proceeding to a detailed study of a specific model of logic, it is necessary to add a word about notation. The terminology used in the following is taken from several fields of science; neurology, electrical engineering, and mathematics furnish most of the words. No attempt is made to be systematic in the application of terms, but it is hoped that the meaning will be clear in every case. It must be kept in mind that few of the terms are being used in the technical sense which is given to them in their own scientific field. Thus, in speaking of a neuron we don’t mean the animal organ, but rather one of the basic components of our network which resembles an animal neuron only superficially, and which might equally well have been called an electrical relay.

### 2.2 Definitions of the fundamental concepts.

Externally an automaton is a “black box” with a finite number of inputs and a finite number of outputs. Each input and each output is capable of exactly two states, to be designated as the “stimulated” state and the “unstimulated” state, respectively. The internal functioning of such a “black box” is equivalent to a prescription which

specifies what outputs will be stimulated in response to the stimulation of any given combination of the inputs, and also of the time of stimulation of these outputs. As stated above, it is definitely assumed that the response occurs only after a time lag, but in the general case the complete response may consist of a succession of responses occurring at different times. This description is somewhat vague. To make it more precise it will be convenient to consider first automata of a somewhat restricted type and to discuss the synthesis of the general automaton later

DEFINITION 1: A single output automaton with time delay  $\delta$  ( $\delta$  is positive) is a finite set of inputs, exactly one output, and an enumeration of certain "preferred" subsets of the set of all inputs. The automaton stimulates its output at time  $t + \delta$  if and only if at time  $t$  the stimulated inputs constitute a subset which appears in the list of "preferred" subsets describing the automaton.

In the above definition the expression "enumeration of certain subsets" is taken in its widest sense and does not exclude the extreme cases "all" or "none." If  $n$  is the number of inputs, then there exist  $2^{(2^n)}$  such automata for any given  $\delta$ .

Frequently several automata of this type will have to be considered simultaneously. They need not all have the same time delay, but it will be assumed that all their time lags are integral multiples of a common value  $\delta_0$ . This assumption may not be correct for an actual nervous system; the model considered may apply only to an idealized nervous system. In partial justification, it can be remarked that as long as only a finite number of automata are considered, the assumption of a common value  $\delta_0$  can be realized within any degree of approximation. Whatever its justification and whatever its meaning in relation to actual machines or nervous systems, this assumption will be made in our present discussions. The common value  $\delta_0$  is chosen for convenience as the time unit. The time variable can now be made discrete, i. e. it need assume only integral numbers as values, and correspondingly the time delays of the automata considered are positive integers.

Single output automata with given time delays can be combined into a new automaton. The outputs of certain automata are connected by lines or wires or nerve fibers to some of the inputs of the same or other automata. The connecting lines are used only to indicate the desired connections; their function is to transmit the stimulation of an output instantaneously to all the inputs connected with that output. The network is subjected to one condition, however. Although the same output may be connected to several inputs, only one input is assumed to be connected to at most one output. It may be clearer to impose this restriction on the connecting lines, by requiring that each input and each output be attached to exactly one line, to allow lines to be split into several lines; but prohibit the merging of two or more lines. This convention makes it advisable to mention again that the activity of an output or an input, and hence of line, is an all or nothing process. If a line is split, the stimulation is carried to all the branches in full. No energy conservation laws enter into the problem. In actual machines or neurons the energy is supplied by the neurons themselves from some external source of energy. The stimulation acts only as a trigger device.

The most general automaton is defined to be any such network. In general it will

have several inputs and several outputs and its response activity will be much more complex than that of a single output automaton with a given time delay. An intrinsic definition of the general automaton, independent of its construction as a network, can be supplied. It will not be discussed here, however.

Of equal importance to the problem of combining automata into new ones is the converse problem of representing a given automaton by a network of simpler automata, and of determining eventually a minimum number of basic types for these simpler automata. As will be shown, very few types are necessary.

### 2.3 Some basic organs.

The automata to be selected as a basis for the synthesis of all automata will be called basic organs. Throughout what follows, these will be single output automata.

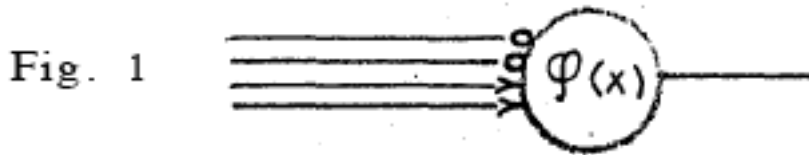

One type of basic organ is described by Figure 1. It has one output, and may have any finite number of inputs. These are grouped into two types: Excitatory and inhibitory inputs. The excitatory inputs are distinguished from the inhibitory inputs by the addition of an arrowhead to the former and of a small circle to the latter. This distinction of inputs into two types does actually not relate to the concept of inputs, it is introduced as a means to describe the internal mechanism of the neuron. This mechanism is fully described by the so-called threshold function  $\varphi(x)$  written inside the large circle symbolizing the neuron in Figure 1, according to the following convention: The output of the neuron is excited at time  $t + 1$  if and only if at time  $t$  the number of stimulated excitatory  $h$  inputs and the number of stimulated inhibitory inputs  $\ell$  satisfy the relation  $h \geq \varphi(\ell)$ . (It is reasonable to require that the function  $\varphi(x)$  be monotone non-decreasing.) For the purposes of our discussion of this subject it suffices to use only certain special classes of threshold functions  $\varphi(x)$ . E.g.

$$(1) \quad \varphi(x) \equiv \psi_h(x) \begin{cases} = 0 & \text{for } x < h \\ = \infty & \text{for } x \geq h \end{cases}$$

(i.e.  $< h$  inhibitions are absolutely ineffective,  $\geq h$  inhibitions are absolutely effective),  
or

$$(2) \quad \varphi(x) \equiv \mathcal{X}_h(x) \equiv x + h$$

(i.e. the excess of stimulations over inhibitions must be  $\geq h$ ). We will use  $\mathcal{X}_h$ , and write the inhibition number  $h$  (instead of  $\mathcal{X}_h$ ) inside the large circle symbolizing

the neuron. Special cases of this type are the three basic organs shown in Figure 2. These are, respectively, a threshold two neuron with two excitatory inputs, a threshold one neuron with two excitatory inputs, and finally a threshold one neuron with one excitatory input and one inhibitory input.

The automata with one output and one input described by the networks shown in Figure 3 have simple properties: The first one's output is never stimulated, the second one's output is stimulated at all times if its input has been ever (previously) stimulated. Rather than add these automata to a network, we shall permit lines leading to an input to be either always non-stimulated, or always stimulated. We call the latter "grounded" and designate it by the symbol  $||\vdash$  and we call the former "live" and designate it by the symbol  $||\dashv$ .

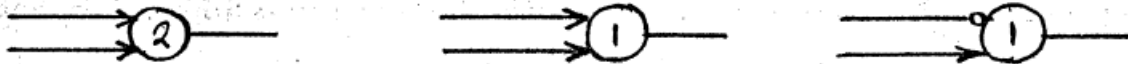

Fig. 2



Fig. 3

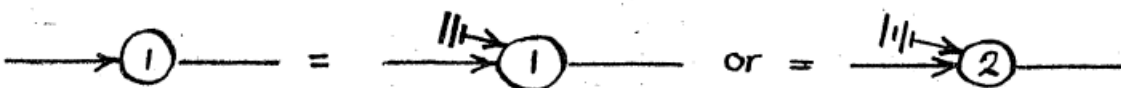

Fig. 4

### 3. AUTOMATA AND THE PROPOSITIONAL CALCULUS

#### 3.1 The Propositional Calculus

The propositional calculus deals with propositions irrespective of their truth. The set of propositions is closed under operations of negation, conjunction and disjunction.

If  $a$  is a proposition, then “not  $a$ ,” denoted by  $a^{-1}$  (we prefer this designation to the more conventional ones  $\neg a$  and  $\sim a$ ), is also a proposition. If  $a, b$  are two propositions, then “ $a$  and  $b$ ,” “ $a$  or  $b$ ,” denoted respectively by  $ab$ ,  $a + b$ , are also propositions. Propositions fall into two sets,  $T$  and  $F$ , depending whether they are true or false. The proposition  $a^{-1}$  is in  $T$  if and only if  $a$  is in  $F$ . The proposition  $ab$  is in  $T$  if and only if  $a$  and  $b$  are both in  $T$ , and  $a + b$  is in  $T$  if and only if either  $a$  or  $b$  is in  $T$ . Mathematically speaking the set of propositions, closed under the three fundamental operations, is mapped by a homomorphism onto the Boolean algebra of the two elements  $\underline{1}$  and  $\underline{0}$ . A proposition is true if and only if it is mapped onto the element  $\underline{1}$ . For convenience, denote by  $\underline{1}$  the proposition  $\bar{a} + \bar{a}^{-1}$ , by  $\underline{0}$  the proposition  $\bar{a}\bar{a}^{-1}$ , where  $\bar{a}$  is a fixed but otherwise arbitrary proposition. Of course,  $\underline{0}$  is false and  $\underline{1}$  is true.

A polynomial  $\mathcal{P}$  in  $n$  variables,  $n \geq 1$ , is any formal expression obtained from  $x_1, \dots, x_n$  by applying the fundamental operations to them a finite number of times, for example  $[(x_1 + x_2^{-1})x_3]^{-1}$  is a polynomial. In the propositional calculus two polynomials in the same variables are considered equal if and only if for any choice of the propositions  $x_1, \dots, x_n$  the resulting two propositions are always either both true or both false. A fundamental theorem of the propositional calculus states that every polynomial  $\mathcal{P}$  is equal to

$$\sum_{i_1=\pm 1} \dots \sum_{i_n=\pm 1} f_{i_1\dots i_n} x_1^{i_1} \dots x_n^{i_n},$$

where each of the  $f_{i_1\dots i_n}$  is equal to  $\underline{0}$  or  $\underline{1}$ . Two polynomials are equal if and only if their  $f$ 's are equal. In particular, for each  $n$ , there exist exactly  $2^{(2^n)}$  polynomials.

### 3.2 Propositions, automata and delays.

These remarks enable us to describe the relationship between automata and the propositional calculus. Given a time delay  $s$ , there exists a one-to-one correspondence between single output automata with time delay  $s$  and the polynomials of the propositional calculus. The number  $n$  of inputs (to be designated  $\nu = 1, \dots, n$ ) is equal to the number of variables. For every combination  $i_1 = \pm 1, \dots, i_n = \pm 1$ , the coefficient  $f_{i_1\dots i_n} = \underline{1}$ , if and only if a stimulation at time  $t$  of exactly those inputs  $\nu$  for which  $i_\nu = 1$ , produces a stimulation of the output at time  $t + s$ .

DEFINITION 2: Given a polynomial  $\mathcal{P} = \mathcal{P}(x_1 \dots x_n)$  and a time delay  $s$ , we mean by a  $\mathcal{P}, s$ -network a network built from the three basic organs of Figure 2, which as an automaton represents  $\mathcal{P}$  with time delay  $s$ .

THEOREM 1: Given any  $\mathcal{P}$ , there exists a (unique)  $s^* = s^*(\mathcal{P})$ , such that a  $\mathcal{P}, s$ -network exists if and only if  $s \geq s^*$ .

PROOF: Consider a given  $\mathcal{P}$ . Let  $S(\mathcal{P})$  be the set of those  $s$  for which a  $\mathcal{P}, s$ -network exists. If  $s' \geq s$ , then tying  $s' - s$  unit-delays, as shown in Figure 4, in series to the output of a  $\mathcal{P}, s$ -network produces a  $\mathcal{P}, s'$ -network. Hence  $S(\mathcal{P})$  contains with an  $s$  all  $s' \geq s$ . Hence if  $S(\mathcal{P})$  is not empty, then it is precisely the set of all  $s \geq s^*$ ,

where  $s^* = s^*(\mathcal{P})$  is its smallest element. Thus the theorem holds for  $\mathcal{P}$  if  $S(\mathcal{P})$  is not empty, i.e. if the existence of at least one  $\mathcal{P}, s$ -network (for, some  $s$ !) is established.

Now the proof can be effected by induction over the number  $\varrho = \varrho(\mathcal{P})$  of symbols used in the definitory expression for  $\mathcal{P}$  (counting each occurrence of each symbol separately).

If  $\varrho(\mathcal{P}) = 1$ , then  $\mathcal{P}(x_i, \dots, x_n) \equiv x_\nu$  (for one of the  $\nu = 1, \dots, n$ ). The "trivial" network which obtains by breaking off all input lines other than  $\nu$ , and taking the input line  $\nu$  directly to the output, solves the problem with  $s = 0$ . Hence  $s^*(\mathcal{P}) = 0$ .

If  $\varrho(\mathcal{P}) > 1$ , then  $\mathcal{P} \equiv \mathcal{Q}^{-1}$  or  $\mathcal{P} \equiv \mathcal{Q}\mathcal{R}$  or  $\mathcal{P} \equiv \mathcal{Q} + \mathcal{R}$ , where  $\varrho(\mathcal{Q}), \varrho(\mathcal{R}) < \varrho(\mathcal{P})$ . For  $\mathcal{P} \equiv \mathcal{Q}^{-1}$  let the box  $\boxed{\mathcal{Q}}$  represent a  $\mathcal{Q}, s'$ -network, with  $s' = s^*(\mathcal{Q})$ . Then the network shown in Figure 5 is clearly a  $\mathcal{P}, s$ -network, with  $s = s' + 1$ . Hence  $s^*(\mathcal{P}) \leq s^*(\mathcal{Q}) + 1$ . For  $\mathcal{P} \equiv \mathcal{Q}\mathcal{R}$  or  $\mathcal{Q} + \mathcal{R}$  let the boxes  $\boxed{\mathcal{Q}}, \boxed{\mathcal{R}}$  represent a  $\mathcal{Q}, s''$ -network and an  $\mathcal{R}, s''$ -network, respectively, with  $s'' = \max(s^*(\mathcal{Q}), s^*(\mathcal{R}))$ . Then the network shown in Figure 6 is clearly a  $\mathcal{P}, s$ -network, with  $\mathcal{P} \equiv \mathcal{Q}\mathcal{R}$  or  $\mathcal{Q} + \mathcal{R}$  for  $h = 2$  or  $1$ , respectively, and with  $s = s'' + 1$ . Hence  $s^*(\mathcal{P}) \leq \max(s^*(\mathcal{Q}), s^*(\mathcal{R})) + 1$ .

Combine the above theorem with the fact that every single output automaton can be equivalently described – apart from its time delay  $s$  – by a polynomial  $\mathcal{P}$ , and that the basic operations  $ab, a + b, a^{-1}$  of the propositional calculus are represented (with unit delay) by the basic organs of Figure 2. (For the last one, which represents  $ab^{-1}$ , cf. the remark at the beginning of 4.1.1. (p. 9)) This gives:

DEFINITION 3: Two single output automata are equivalent in the wider sense, if they differ only in their time delays – but otherwise the same input stimuli produce the same output stimulus (or non-stimulus) in both.

THEOREM 2 (Reduction Theorem): Any single output automaton  $\vartheta$  is equivalent in the wider sense to a network of basic organs of Figure 2. There exists a (unique)  $s = s^*(\vartheta)$ , such that the latter network exists if and only if its prescribed time delay  $s$  satisfies  $s \geq s^*$ .

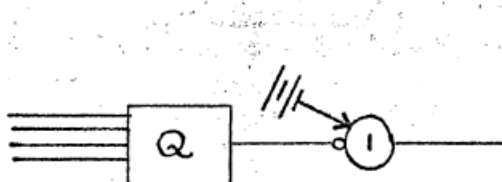

Fig. 5

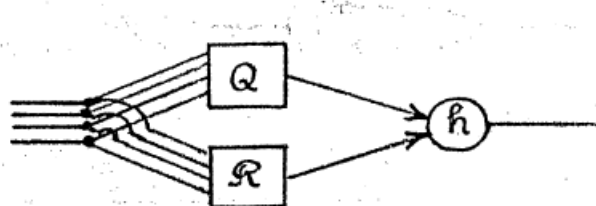

Fig. 6

### 3.3 Universality. General logical considerations.

Now networks of arbitrary single output automata can be replaced by networks of basic organs of Figure 2: It suffices to replace the unit delay in the former system by  $\bar{s}$  unit delays in the latter, where  $\bar{s}$  is the maximum of the  $s^*(\vartheta)$  of all the single output automata that occur in the former system. Then all delays that will have to be matched will be multiples of  $\bar{s}$ , hence  $\geq \bar{s}$ , hence  $\geq s^*(\vartheta)$  for all  $\vartheta$  that can occur in this situation, and so the Reduction Theorem will be applicable throughout.

Thus this system of basic organs is universal: It permits the construction of essentially equivalent networks to any network that can be constructed from any system of single output automata. I.e. no redefinition of the system of basic organs can extend the logical domain covered by the derived networks.

The general automaton is any network of single output automata in the above sense. It must be emphasized that, in particular, feedbacks, i.e. arrangements of lines which may allow cyclical stimulation sequences, are allowed. (I.e. configurations like those shown in Figure 7, etc. There will be various, non-trivial, examples of this later.) The above arguments have shown that a limitation of the underlying single output automata to our original basic organs causes no essential loss of generality. The question as to which logical operations can be equivalently represented (with suitable, but not *a priori* specified delays) is nevertheless not without difficulties.

These general automata are, in particular, not immediately equivalent to all of effectively constructive (intuitionistic), logics. I.e. given a problem involving (a finite number of) variables, which can be solved (identically in these variables) by effective construction, it is not always possible to construct a general automaton that will produce this solution identically (i.e. under all conditions). The reason for this is essentially, that the memory requirements of such a problem may depend on (actual values assumed by) the variables (i.e. they must be finite for any specific system of values of the variables, but they may be unbounded for the totality of all possible systems of values), while a general automaton in the above sense, necessarily has a fixed memory capacity. I.e. a fixed general automaton can only handle (identically, i.e. generally) a problem with fixed (bounded) memory requirements.

We need not go here into the details of this question. Very simple addenda can be introduced to provide for a (finite but) unlimited memory capacity. How this can be done has been shown by A. M. Turing [5]. Turing's analysis loc. cit. also shows that with such addenda general automata become strictly equivalent to effectively constructive (intuitionistic) logics. Our system in its present form (i.e. general automata with limited memory capacity) is still adequate for the treatment of all problems with neurological analogies, as our subsequent examples will show. (Cf. also W. S. McCulloch and W. Pitts [2].) The exact logical domain that they cover has been recently characterized by Kleene [1]. We will return to some of these questions in 5.1.



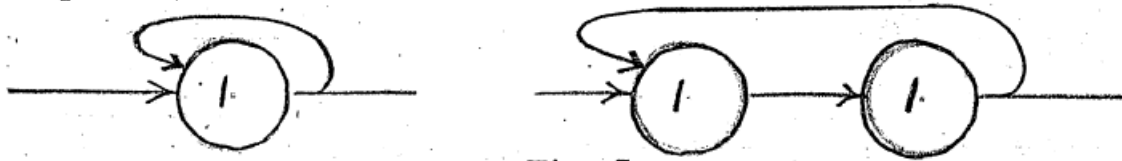

Fig. 7

## 4. BASIC ORGANS.

### 4.1 Reduction of the basic components.

#### 4.1.1 The simplest reductions.

The previous Section makes clear the way in which the elementary neurons should be interpreted logically. Thus the ones shown in Figure 2 (p. 5) respectively represent the logical functions  $ab$ ,  $a + b$ , and  $ab^{-1}$ . In order to get  $b^{-1}$ , it suffices to make the  $a$ -terminal of the third organ, as shown in Figure 8, live. This will be abbreviated in the following, as shown in Figure 8.

Now since  $ab \equiv ((a^{-1}) + (b^{-1}))^{-1}$  and  $a + b \equiv ((a^{-1})(b^{-1}))^{-1}$ , it is clear that the first organ among the three basic organs shown in Figure 2 is equivalent to a system built of the remaining two organs there, and that the same is true for the second organ there. Thus the first and second organs shown in Figure 2 are respectively equivalent (in the wider sense) to the two networks shown in Figure 9. This tempts one to consider a new system, in which  $\text{---}\bigcirc\text{---}$  (viewed as a basic entity in its own right, and not an abbreviation for a composite, as in Figure 8), and either the first or the second basic organ in Figure 2, are the basic organs. They permit forming the second or the first basic organ in Figure 2, respectively, as shown above, as (composite) networks. The third basic organ in Figure 2 is easily seen to be also equivalent (in the wider sense) to a composite of the above but, as was observed at the beginning of 4.1.1 (p. 9) the necessary organ is in any case not this, but  $\text{---}\bigcirc\text{---}$  (cf. also the remarks concerning Figure 8), respectively. Thus either system of new basic organs permits reconstructing (as composite networks) all the (basic) organs of the original system. It is true, that these constructs have delays varying from 1 to 3, but since unit delays, as shown in Figure 4, are available in either new system, all these delays can be brought up to the value 3. Then a trebling of the unit delay time obliterates all differences.

To restate: Instead of the three original basic organs, shown again in Figure 10, we can also (essentially equivalently) use the two basic organs Nos. one and three or Nos. two and three in Figure 10.

## 4.1.2 The double line trick.

This result suggests strongly that one consider the one remaining combination, too: The two basic organs Nos. one and two in Figure 10, as the basis of an essentially equivalent system.

One would be inclined to infer that the answer must be negative: No network built out of the two first basic organs of Figure 10 can be equivalent (in the wider sense) to the last one. Indeed, let us attribute to  $T$  and  $F$ , i.e. to the stimulated or non-stimulated state of a the, respectively, the “truth values”  $\underline{1}$  or  $\underline{0}$ , respectively. Keeping the ordering  $\underline{0} < \underline{1}$  in mind, the state of the output is a monotone non-decreasing function of the states of the inputs for both basic organs Nos. one and two in Figure 10, and hence for all networks built from these organs exclusively as well. This, however is not the case for the last organ of Figure 10 (nor for the last organ of Figure 2), irrespectively of delays.

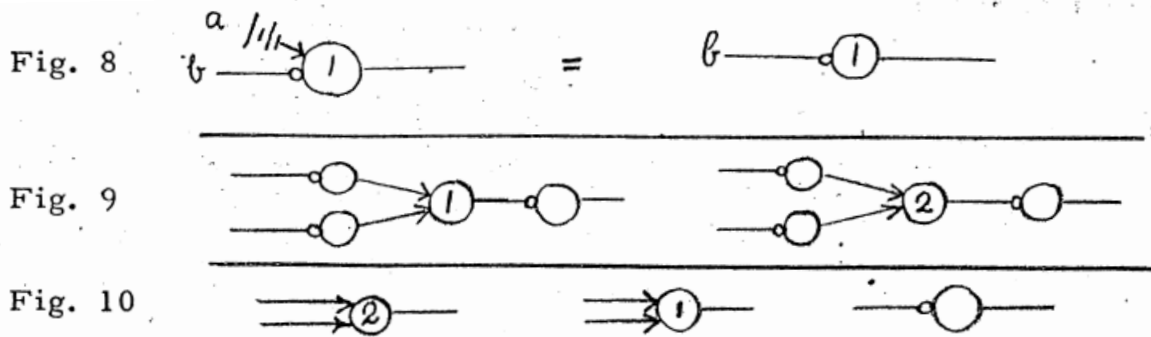

Nevertheless a slight change of the underlying definitions permits one to circumvent this difficulty and to get rid of the negation (the last organ of Figure 10) entirely. The device which effects this is of additional methodical interest, because it may be regarded as the prototype of one that we will use later on in a more complicated situation. The trick in question is to represent propositions on a double line instead of single one. One assumes that of the two lines, at all times precisely one is stimulated. Thus there will always be two possible states of the line pair: The first line stimulated, the second non-stimulated; and the second line stimulated, the first non-stimulated. We let one of these states correspond to the stimulated single line of the original system – that is, to a true proposition – and the other state to the unstimulated single line – that is, to a false proposition. Then the three fundamental Boolean operations can be represented by the three first schemes shown in Figure 11. (The last scheme shown in Figure 11 relates to the original system of Figure 2.)

In these diagrams, a true proposition corresponds to 1 stimulated, 2 unstimulated, while a false proposition corresponds to 1 unstimulated, 2 stimulated. The networks of Figure 11, with the exception of the third one, have also the correct delays: Unit delay. The third one has zero delay, but whenever this is not wanted, it can be replaced by unit delay; by replacing the third network by the fourth one, making its  $a_1$ -line live, its  $a_2$ -line grounded, and then writing  $a$  for its  $b$ .

Summing up: Any two of the three (single delay) organs of Figure 10 – which

may simply be designated by  $ab$ ,  $a + b$ ,  $a^{-1}$  - can be stipulated to be the basic organs, and yield a system that is essentially equivalent to the original one.

Fig. 11

$ab$  — organ No. 1 of Figure 2 or 10:

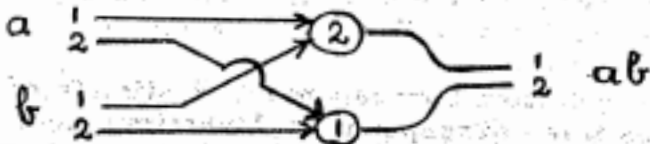

$a+b$  — organ No. 2 of Figure 2 or 10:

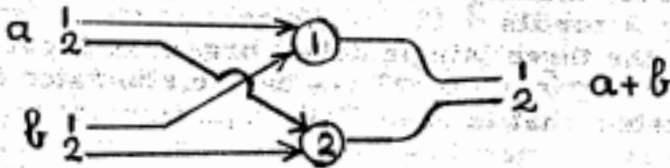

$a^{-1}$  — organ No. 3 of Figure 10:

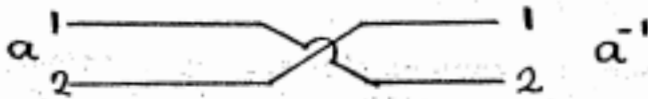

$ab^{-1}$  — organ No. 3 of Figure 2:

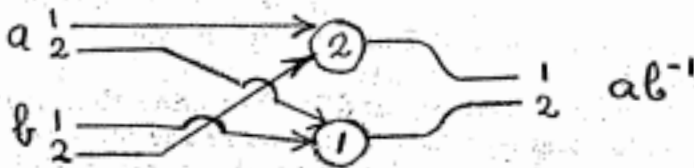
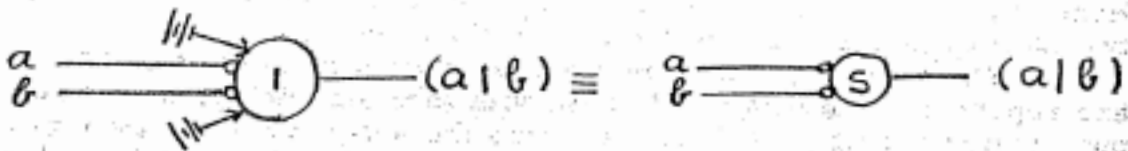

Figure 12.

$$(a|b) \equiv (ab)^{-1} :$$



## 4.2 Single basic organs.

### 4.2.1 The Scheffer stroke.

It is even possible to reduce the number of basic organs to one, although it cannot be done with any of the three organs enumerated above. We will, however, introduce two new organs, either of which suffices by itself.

The first universal organ corresponds to the well-known "Scheffer stroke" function. Its use in this context was suggested by K. A. Brückner and M. Gell-Mann. In symbols, it can be represented (and abbreviated) as shown on Figure 12. The three fundamental Boolean operations can now be performed as shown in Figure 13.

Figure 13.

$ab$  — organ No. 1 of Figure 10:



$a + b$  — organ No. 2 of Figure 10:

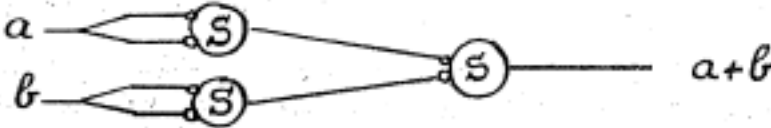

$a^{-1}$  — organ No. 3 of Figure 10:



The delays are 2, 2, 1, respectively, and in this case the complication caused by these delay-relationships is essential. Indeed, the output of the Scheffer-stroke is an antimonotone function of its inputs. Hence in every network derived from it, even-delay outputs will be monotone functions of its inputs, and anti-delay outputs will be antimonotone ones. Now  $ab$  and  $a + b$  are not antimonotone, and  $ab^{-1}$  and  $a^{-1}$  are not monotone. Hence no delay-value can simultaneously accommodate in this set up one of the two first organs and one of the two last organs.

The difficulty can, however, be overcome as follows:  $ab$  and  $a + b$  are represented in Figure 13, both with the same delay, namely 2. Hence our earlier result (in 4.1.2), securing the adequacy of the system of the two basic organs  $ab$  and  $a + b$  applies: Doubling the unit delay time reduces the present set up (Scheffer stroke only!) to the one referred to above.

4.2.2 The majority organ.

The second universal organ is the “majority organ.” In symbols, it is shown (and alternatively designated) in Figure 14. To get conjunction and disjunction is a simple matter, as shown in Figure 15. Both delays are 1. Thus  $ab$  and  $a + b$  (according to Figure 10) are correctly represented, and the new system (majority organ only!) is adequate because the system based on those two organs is known to be adequate (cf. 4.1.2).

Figure 14.

$$m(a, b, c) \equiv ab + ac + bc \equiv (a+b)(a+c)(b+c) :$$

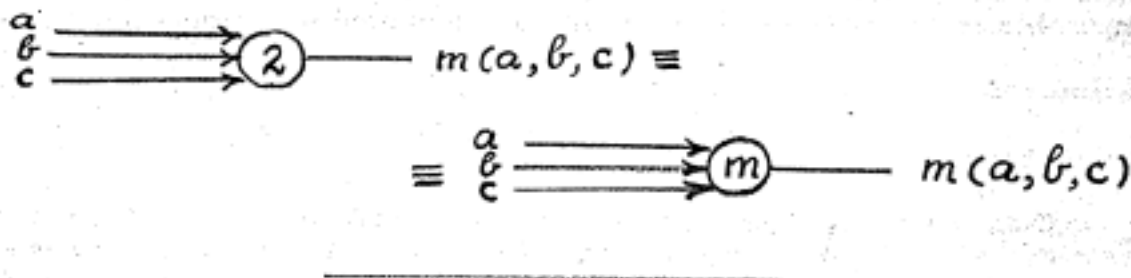
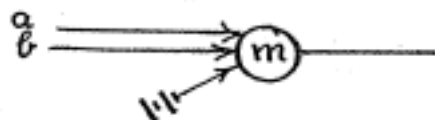

Figure 15.

$ab$  :



$a+b$  :



## 5. LOGICS AND INFORMATION.

## 5.1 Intuitionistic logics.

All of the examples which have been described in the last two Sections have had a certain property in common; in each, a stimulus of one of the inputs at the left could be traced through the machine until at a certain time later it came out as a stimulus of the output on the right. To be specific, no pulse could ever return to a neuron through which it had once passed. A system with this property is called circle-free by W. S. McCulloch and W. Pitts [2]. While the theory of circle-free machines is attractive because of its simplicity, it is not hard to see that these machines are very limited in their scope.

When the assumption of no circles in the network is dropped, the situation is radically altered. In this far more complicated case, the output of the machine at any time may depend on the state of the inputs in the indefinitely remote past. For example, the simplest kind of cyclic circuit, as shown in Figure 16, is a kind of memory machine. Once this organ has been stimulated by  $a$ , it remains stimulated and sends forth a pulse in  $b$  at all times thereafter. With more complicated networks, we can construct machines which will count, which will do simple arithmetic, and which will even perform certain unlimited inductive processes. Some of these will be illustrated by examples in Section 6 (p. 16). The use of cycles or feedback in automata extends the logic of constructable machines to a large portion of intuitionistic logic. Not all of intuitionistic logic is so obtained, however, since these machines are limited by their fixed size. (For this and for the remainder of this Section; cf. also the remarks at the end of 3.3. (p. 7)) Yet if our automata are furnished with an unlimited memory – for example an infinite tape, and scanners connected to afferent organs, along with suitable efferent organs to perform motor operations and/or print on the tape – the logic of constructable machines becomes precisely equivalent to intuitionistic logic (see A. M. Turing [5]). In particular, all numbers computable in the sense of Turing can be computed by some such network.



Fig. 16

## 5.2 Information.

### 5.2.1 General observations.

Our considerations deal with varying situations, each of which contains a certain amount of information. It is desirable to have a means of measuring that amount. In most cases of importance, this is possible. Suppose an event is one selected from a finite set of possible events. Then the number of possible events can be regarded as a measure of the information content of knowing which event occurred, provided all events are *a priori* equally probable. However, instead of using the number  $n$  of possible events as the measure of information, it is advantageous to use a certain function of  $n$ , namely the logarithm. This step can be (heuristically) justified as follows: If two physical systems I and II represent  $n$  and  $m$  (*a priori* equally probable) alternatives, respectively, then the union I+II represents  $nm$  such alternatives. Now it is desirable that the (numerical) measure of information be (numerically) additive under this (substantively) additive composition I+II. Hence some function  $f(n)$  should be used instead of  $n$ , such that

$$(3) \quad f(nm) = f(n) + f(m).$$

In addition, for  $n > m$  I represents more information than II, hence it is reasonable to require

$$(4) \quad n > m \quad \text{implies} \quad f(n) > f(m).$$

Note, that  $f(n)$  is defined for  $n = 1, 2, \dots$  only. From (3), (4) one concludes easily, that

$$(5) \quad f(n) \equiv C \ln n$$

for some constant  $C > 0$ . (Since  $f(n)$  is defined for  $n = 1, 2, \dots$  only, (3) alone does not imply this, even not with a constant  $C \stackrel{\geq}{\leq} 0$  !) Next, it is conventional to let the minimum non-vanishing amount of information, i.e. that which corresponds to  $n = 2$ , be the unit of information – the “bit.” This means that  $f(2) = 1$ , i.e.  $C = 1/\log 2$ . and so

$$(6) \quad f(n) \equiv {}^2\log n.$$

This concept of information was successively developed by several authors in the late 1920's and early 1930's, and finally integrated into a broader system by C. E. Shannon [3].

### 5.2.2 Examples

The following simple examples give some illustration: The outcome of the flip of a coin is one bit. That of the roll of a die is  ${}^2\log 6 \approx 2.5$  bits. A decimal digit represents

${}^2\log 10 \approx 3.3$  bits, a letter of the alphabet represents  ${}^2\log 26 \approx 4.7$  bits, a single character from a 44-key 2-setting typewriter represents  ${}^2\log(44 \times 2) = 6.5$  bits. (In all these we assume, for the sake of the argument, although actually unrealistically, *a priori* equal probability of all possible choices.) It follows that any line or nerve fiber which can be classified as either stimulated or non-stimulated carries precisely one bit of information, while a bundle of  $n$  such lines can communicate  $n$  bits. It is important to observe that this definition is possible only on the assumption that a background of *a priori* knowledge exists, namely, the knowledge of a system of *a priori* equally probable events.

This definition can be generalized to the case where the possible events are not all equally probable. Suppose the events are known to have probabilities  $p_1, p_2, \dots, p_n$ . Then the information contained in the knowledge of which of these events actually occurs, is defined to be

$$(7) \quad H = \sum_{i=1}^n p_i {}^2\log p_i \quad (\text{bits}).$$

In case  $p_1 = p_2 = \dots = p_n = 1/n$ , this definition is the same as the previous one. This result, too, was obtained by C. E. Shannon [3], although it is implicit in the earlier work of L. Szilard [4].

An important observation about this definition is that it bears close resemblance to the statistical definition of the entropy of a thermodynamical system. If the possible events are just the known possible states of the system with their corresponding probabilities, then the two definitions are identical. Pursuing this, one can construct a mathematical theory of the communication of information patterned after statistical mechanics. (See L. Szilard [4] and C. E. Shannon [3].) That information theory should thus reveal itself as an essentially thermodynamical discipline, is not at all surprising: The closeness and the nature of the connection between information and entropy is inherent in L. Boltzmann's classical definition of entropy (apart from a constant, dimensional factor) as the logarithm of the "configuration number." The "configuration number" is the number of *a priori* equally probable states that are compatible with the macroscopic description of the state – i.e. it corresponds to the amount of (microscopic) information that is missing in the (macroscopic) description.

## 6. TYPICAL SYNTHESSES OF AUTOMATA.

### 6.1 The memory unit.

One of the best ways to become familiar with the ideas which have been introduced, is to study some concrete examples of simple networks. This Section is devoted to a consideration of a few of them.

The first example will be constructed with the help of the three basic organs of Figure 10. It is shown in Figure 18. It is a slight rearrangement of the primitive



memory network of Figure 16.

This network has two inputs  $a$  and  $b$  and one output  $x$ . At time  $t$ ,  $x$  is stimulated if and only if  $a$  has been stimulated at an earlier time, so that no stimulation of  $b$  has occurred since then. Roughly speaking, the machine remembers whether  $a$  or  $b$  was the last input to be stimulated. Thus  $x$  is stimulated if it has been stimulated immediately before — to be designated by  $x'$  — or if  $a$  has been stimulated immediately before, but  $b$  has not been stimulated immediately before. This is expressed by the formula  $x = (x' + a)b^{-1}$ , i.e. by the network shown in Figure 17. Now  $x$  should be fed back into  $x'$  (since  $x'$  is the immediately preceding state of  $x$ ). This gives the network shown in Figure 18, where this branch of  $x$  is designated by  $y$ . However, the delay of the first network is 2, hence the second network's memory extends over past events that lie an even number of time (delay) units back. I.e. the output  $x$  is stimulated if and only if  $a$  has been stimulated at an earlier time, an even number of units before, so that no stimulation of  $b$  has occurred since then, also an even number of units before. Enumerating the time units by an integer  $t$ , it is thus seen that this network represents a separate memory for even and for odd  $t$ . For each case it is a simple “off-on,” i.e. one bit, memory. Thus it is in its entirety a two bit memory.

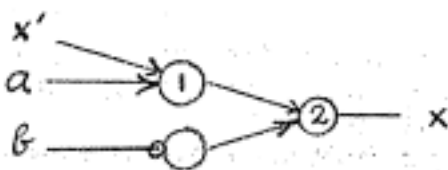

Fig. 17

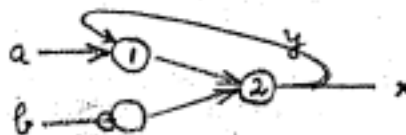

Fig. 18

## 6.2 Scalers.

In the examples that follow, free use will be made of the general family of basic organs considered in 2.3, at least for all  $\varphi = \chi_h$  (cf. (2) there). The reduction thence to elementary organs in the original sense is secured by the Reduction Theorem in 3.2, and in the subsequently developed interpretations, according to Section 4, by our considerations there. It is therefore unnecessary to concern ourselves here with these reductions.

The second example is a machine which counts input stimuli by twos. It will be called a “scaler by two.” Its diagram is shown in Figure 19.

By adding another input, the repressor, the above mechanism can be turned off at will. The diagram becomes as shown in Figure 20. The result will be called a “scaler by two” with a repressor and denoted as indicated by Figure 20.

In order to obtain larger counts, the “scaler by two” networks can be hooked in series. Thus a “scaler by  $2^n$ ” is shown in Figure 21. The use of the repressor is of course optional here. “Scalers by  $m$ ,” where  $m$  is not necessarily of the form  $2^n$ , can also be constructed with little difficulty, but we will not go into this here.

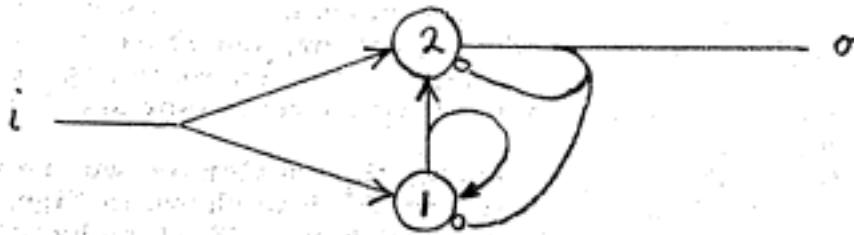

Fig. 19

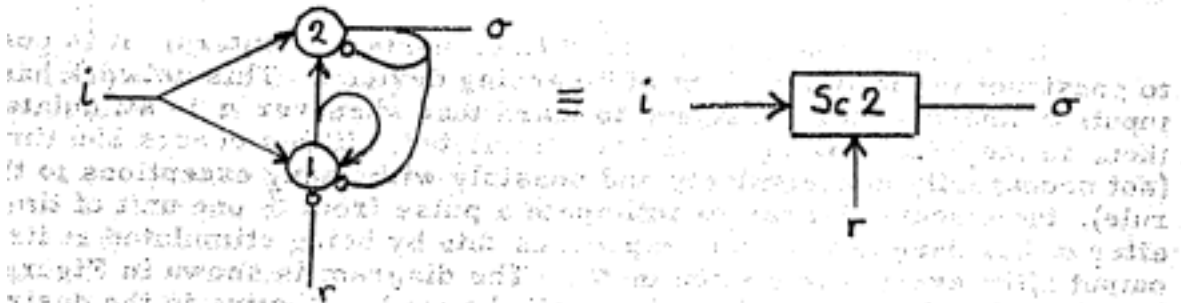

Fig. 20

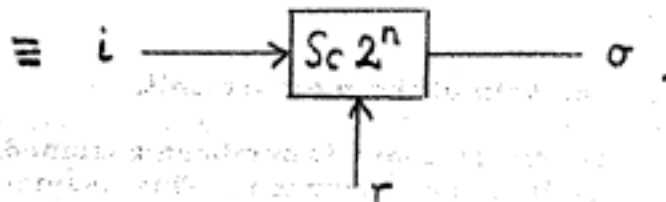
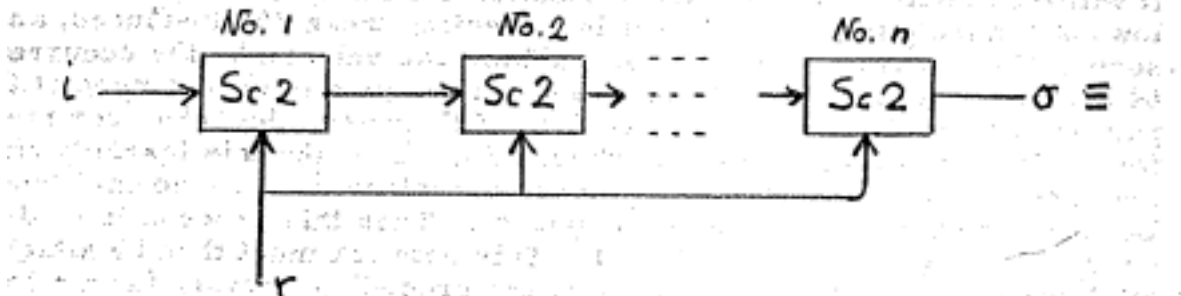

Fig. 21

### 6.3 Learning.

Using these “scalers by  $2^n$ ” (i.e.  $n$ -stage counters), it is possible to construct the following sort of “learning device.” This network has two inputs  $a$  and  $b$ . It is designed to learn that whenever  $a$  is stimulated, then, in the next instant,  $b$  will be stimulated. If this occurs 256 times (not necessarily consecutively and possibly with many exceptions to the rule), the machine learns to anticipate a pulse from  $b$  one unit of time after  $a$  has been active, and expresses this by being stimulated at its  $b$  output after every stimulation of  $a$ . The diagram is shown in Figure 22. (The “expression” described above will be made effective in the desired sense by the network of Figure 24, cf. its discussion below).

This is clearly learning in the crudest and most inefficient way, only. With some effort, it is possible to refine the machine so that, first, it will learn only if it receives no counter-instances of the pattern “ $b$  follows  $a$ ” during the time when it is collecting these 256 instances; and, second having once learned, the machine can unlearn by the occurrence of 64 counter-examples to “ $b$  follows  $a$ ” if no (positive) instances of this pattern interrupt the (negative) series. Otherwise, the behavior is as before. The diagram is shown in Figure 23. To make this learning effective, one has to use  $x$  to gate  $a$  so as to replace  $b$  at its normal functions. Let these be represented by an output  $c$ . Then this process is mediated by the network shown in Figure 24. This network must then be attached to the lines  $a, b$  and to the output  $x$  of the preceding network (according to Figures 22, 23).

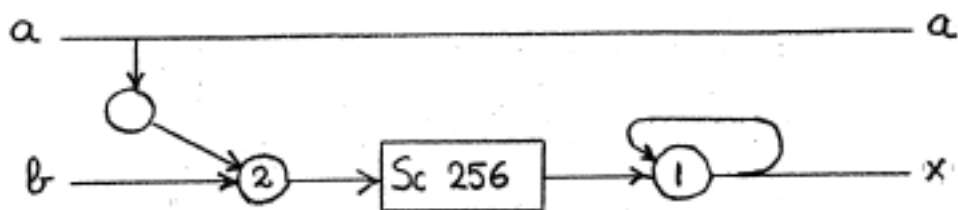

Fig. 22

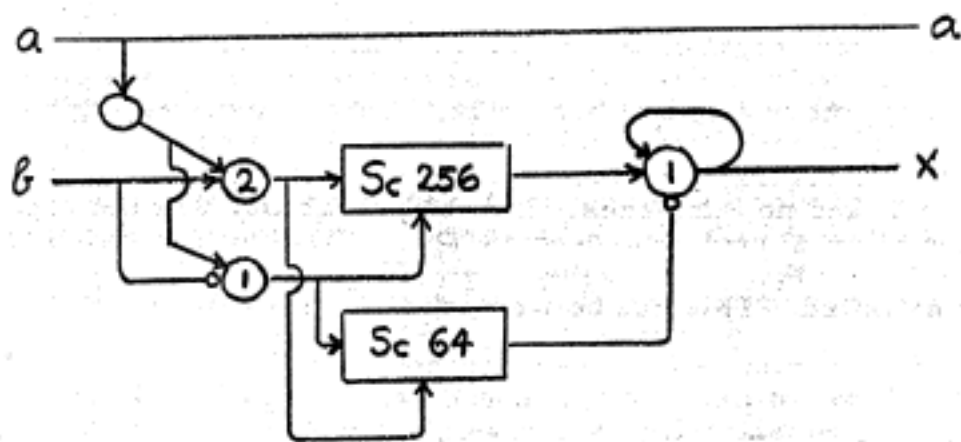

Fig. 23

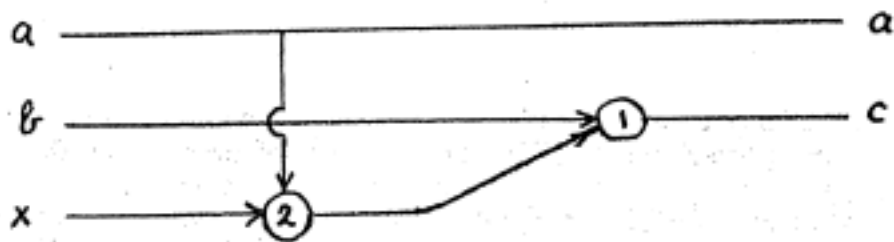

Fig. 24

## 7. THE ROLE OF ERROR.

### 7.1 Exemplification with the help of the memory unit.

In all the previous considerations, it has been assumed that the basic components were faultless in their performance. This assumption is clearly not a very realistic one. Mechanical devices as well as electrical ones are statistically subject to failure, and the same is probably true for animal neurons too. Hence it is desirable to find a closer approximation to reality as a basis for our constructions, and to study this revised situation. The simplest assumption concerning errors is this: With every basic organ is associated a positive number such that in any operation, the organ will fail to function correctly with the (precise) probability  $\epsilon$ . This malfunctioning is assumed to occur statistically independently of the general state of the network and of the occurrence of other malfunctions. A more general assumption, which is a good deal more realistic, is this: The malfunctions are statistically dependent on the general state of the network and on each other. In any particular state, however, a malfunction of the basic organ in question has a probability of malfunctioning which is  $\leq \epsilon$ . For the present occasion, we make the first (narrower and simpler) assumption, and that with a single  $\epsilon$ : Every neuron has statistically independently of all else exactly the probability  $\epsilon$  of misfiring. Evidently, it might as well be supposed  $\epsilon \leq \frac{1}{2}$ , since an organ which consistently misbehaves with a probability  $> \frac{1}{2}$ , is just behaving with the negative of its attributed function, and a (complementary) probability of error  $< \frac{1}{2}$ . Indeed, if the organ is thus redefined as its own opposite, its  $\epsilon (> \frac{1}{2})$  goes then over into  $1 - \epsilon (< \frac{1}{2})$ . In practice it will be found necessary to have  $\epsilon$  a rather small number, and one of the objectives of this investigation is to find the limits of this smallness, such that useful results can still be achieved.

It is important to emphasize that the difficulty introduced by allowing error is not so much that incorrect information will be obtained, but rather that irrelevant results will be produced. As a simple example, consider the memory organ of Figure 16. Once stimulated, this network should continue to emit pulses at all later times; but suppose it has the probability  $\epsilon$  of making an error. Suppose the organ receives a stimulation at time  $t$  and no later ones. Let the probability that the organ is still excited after  $s$  cycles be denoted  $\rho_s$ . Then the recursion formula

$$\rho_{s+1} = (1 - \epsilon)\rho_s + \epsilon(1 - \rho_s)$$

is clearly satisfied. This can be written

$$\rho_{s+1} - \frac{1}{2} = (1 - 2\epsilon)(\rho_s - \frac{1}{2})$$

and so

$$(8) \quad \rho_s - \frac{1}{2} = (1 - 2\epsilon)^s (\rho_0 - \frac{1}{2}) \approx e^{-2\epsilon s} (\rho_0 - \frac{1}{2})$$

for small  $\epsilon$ . The quantity  $\rho_s - \frac{1}{2}$  can be taken as a rough measure of the amount of discrimination in the system after the  $s$ -th cycle. According to the above formula,  $\rho_s \rightarrow \frac{1}{2}$  as  $s \rightarrow \infty$  – a fact which is expressed by saying that, after a long time, the memory content of the machine disappears, since it tends to equal likelihood of being right or wrong. i.e. to irrelevancy.

## 7.2 The general definition.

This example is typical of many. In a complicated network, with long stimulus-response chains, the probability of errors in the basic organs makes the response of the final outputs unreliable, i.e. irrelevant, unless some control mechanism prevents the accumulation of these basic errors. We will consider two aspects of this problem. Let the data be these: The function which the automaton is to perform is given; a basic organ is given (Scheffer stroke, for example); a number  $\epsilon$  ( $< \frac{1}{2}$ ), which is the probability of malfunctioning of this basic organ, is prescribed. The first question is: Given  $\delta > 0$ , can a corresponding automaton be constructed from the given organs, which will perform the desired function and will commit an error (in the final result. i.e. output) with probability  $\leq \delta$ ? How small can  $\delta$  be prescribed? The second question is: Are there other ways to interpret the problem which will allow us to improve the accuracy of the result?

## 7.3 An apparent limitation.

In partial answer to the first question, we notice now that  $\delta$ , the prescribed maximum allowable (final) error of the machine, must not be less than  $\epsilon$ . For any output of the automaton is the immediate result of the operation of a single final neuron and the reliability of the whole system cannot be better than the reliability of this last neuron.

## 7.4 The multiple line trick.

In answer to the second question, a method will be analyzed by which this threshold restriction  $\delta \geq \epsilon$  can be removed. In fact we will be able to prescribe  $\delta$  arbitrarily small (for suitable, but fixed,  $\epsilon$ ). The trick consists in carrying all the messages simultaneously on the bundle of  $N$  lines ( $N$  is a large integer) instead of just a single or double strand as in the automata described up to now. An automaton would then be represented by a black box with several bundles of inputs and outputs, as shown in Figure 25. Instead of requiring that all or none of the lines of the bundle be stimulated, a certain critical (or fiduciary) level  $\Delta$  is set:  $0 < \Delta < \frac{1}{2}$ . The stimulation of  $\geq (1 - \Delta)N$  lines of a bundle is interpreted as a positive state of the bundle. The stimulation of  $\leq \Delta N$  lines is considered as a negative state. All levels of stimulation between these values are intermediate or undecided. It will be shown

that by suitably constructing the automaton, the number of lines deviating from the “correctly functioning” majorities of their bundles can be kept at or below the critical level  $\Delta N$  (with arbitrarily high probability). Such a system of construction is referred to as “multiplexing.” Before turning to the multiplexed automata, however, it is well to consider the ways in which error can be controlled in our customary single line networks.

## 8. CONTROL OF ERROR IN SINGLE LINE AUTOMATA.

### 8.1 The simplified probability assumption.

In 7.3 (p. 22) it was indicated that when dealing with an automaton in which messages are carried on a single (or even a double) line, and in which the components have a definite probability  $\epsilon$  of making an error, there is a lower bound to the accuracy of the operation of the machine. It will now be shown that it is nevertheless possible to keep the accuracy within reasonable bounds by suitably designing the network. For the sake of simplicity only circle-free automata (cf. 5.1 (p. 14)) will be considered in this Section, although the conclusions could be extended, with proper safeguards, to all automata. Of the various essentially equivalent systems of basic organs (cf. Section 4 (p. 9)) it is, in the present instance, most convenient to select the majority organ, which is shown in Figure 14 (p. 13), as the basic organ for our networks. The number  $\epsilon$  ( $0 < \epsilon < \frac{1}{2}$ ) will denote the probability each majority organ has for malfunctioning.

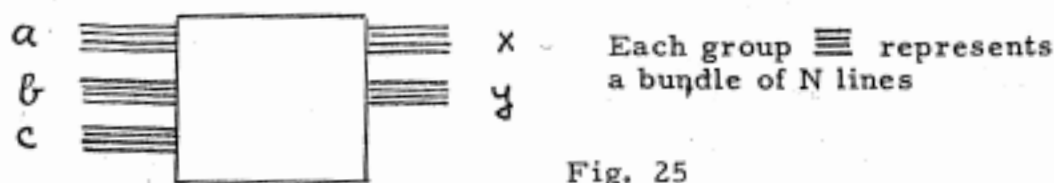

### 8.2 The majority organ.

We first investigate upper bounds for the probability of errors as impulses pass through a single majority organ of a network. Three lines constitute the inputs of the majority organ. They come from other organs or are external inputs of the network. Let  $\eta_1, \eta_2, \eta_3$  be three numbers ( $0 < \eta_i \leq 1$ ), which are respectively upper bounds for the probabilities that these lines will be carrying the wrong impulses. Then  $\epsilon + \eta_1 + \eta_2 + \eta_3$  is an upper bound for the probability that the output line of the majority organ will act improperly. This upper bound is valid in all cases. Under proper circumstances it can be improved. In particular, assume: (i) The probabilities of errors in the input lines are independent, (ii) under proper functioning of

the network, these lines should always be in the same state of excitation (either all stimulated, or all unstimulated). In this latter case

$$\Theta = \eta_1\eta_2 + \eta_1\eta_3 + \eta_2\eta_3 - 2\eta_1\eta_2\eta_3$$

is an upper bound for at least two of the input lines carrying the wrong impulses, and thence

$$\epsilon' = (1 - \epsilon)\Theta + \epsilon(1 - \Theta) = \epsilon + (1 - 2\epsilon)\Theta$$

is a smaller upper bound for the probability of failure in the output line. If all  $\eta_i \leq \eta$ , then  $\epsilon + 3\eta$  is a general upper bound, and

$$\epsilon + (1 - 2\epsilon)(3\eta^2 - 2\eta^3) \leq \epsilon + 3\eta^2$$

is an upper bound for the special case. Thus it appears that in the general case each operation of the automaton increases the probability of error since  $\epsilon + 3\eta > \eta$ , so that if the serial depth of the machine (or rather of the process to be performed) is very great, it will be impractical or impossible to obtain any kind of accuracy. In the special case, on the other hand, this is not necessarily so  $\epsilon + 3\eta^2 < \eta$  is possible. Hence, the chance of keeping the error under control lies in maintaining the conditions of the special case throughout the construction. We will now exhibit a method which achieves this.

## 8.3 Synthesis of Automata.

### 8.3.1 The heuristic argument.

The basic idea in this procedure is very simple. Instead of running the incoming data into a single machine, the same information is simultaneously fed into a number of identical machines, and the result that comes out of a majority of these machines is assumed to be true. It must be shown that this technique can really be used to control error.

Denote by  $O$  the given network (assume two outputs in the specific instance pictured in Figure 26). Construct  $O$  in triplicate, labeling the copies  $O^1, O^2, O^3$  respectively. Consider the system shown in Figure 26.

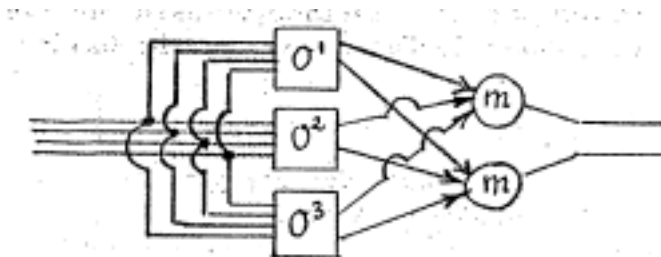

Fig. 26.



For each of the final majority organs the conditions of the special case considered above obtain. Consequently, if  $\eta$  is an upper bound for the probability of error at any output of the original network  $O$ , then

$$(9) \quad \eta^* = \epsilon + (1 - 2\epsilon)(3\eta^2 - 2\eta^3) \equiv f_\epsilon(\eta)$$

is an upper bound for the probability of error at any output of the new network  $O^*$ . The graph is the curve  $\eta^* = f_\epsilon(\eta)$ , shown in Figure 27.

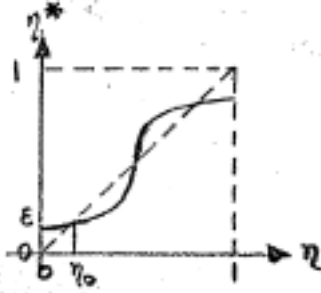

Fig. 27

Consider the intersections of the curve with the diagonal  $\eta^* = \eta$ : First,  $\eta = \frac{1}{2}$  is at any rate such an intersection. Dividing  $\eta - f_\epsilon(\eta)$  by  $\eta - \frac{1}{2}$  gives  $2((1 - 2\epsilon)\eta^2 - (1 - 2\epsilon)\eta + \epsilon)$ , hence the other intersections are the roots of  $(1 - 2\epsilon)\eta^2 - (1 - 2\epsilon)\eta + \epsilon = 0$ , i.e.

$$\eta = \frac{1}{2} \left( 1 \pm \sqrt{\frac{1 - 6\epsilon}{1 - 2\epsilon}} \right)$$

I.e. for  $\epsilon \geq \frac{1}{6}$  they do not exist (being complex (for  $\epsilon > \frac{1}{6}$ ) or  $= \frac{1}{2}$  (for  $\epsilon = \frac{1}{6}$ )); while for  $\epsilon < \frac{1}{6}$  they are  $\eta = \eta_0, 1 - \eta_0$ , where

$$(10) \quad \eta_0 = \frac{1}{2} \left( 1 - \sqrt{\frac{1 - 6\epsilon}{1 - 2\epsilon}} \right) = \epsilon + 3\epsilon^2 + \dots$$

For  $\eta = 0; \eta^* = \epsilon > \eta$ . This, and the monotony and continuity of  $\eta^* = f_\epsilon(\eta)$  therefore imply:

First case,  $\epsilon \geq \frac{1}{6}$ :  $0 \leq \eta < \frac{1}{2}$  implies  $\eta < \eta^* < \frac{1}{2}$ ;  $\frac{1}{2} < \eta \leq 1$  implies  $\frac{1}{2} < \eta^* < \eta$ .

Second case,  $\epsilon < \frac{1}{6}$ :  $0 \leq \eta < \eta_0$  implies  $\eta < \eta^* < \eta_0$ ;  $\eta_0 < \eta \leq \frac{1}{2}$  implies  $\eta_0 < \eta^* < \eta$ ;  $\frac{1}{2} < \eta < 1 - \eta_0$  implies  $\eta < \eta^* < 1 - \eta_0$ ;  $1 - \eta_0 < \eta < 1$  implies  $1 - \eta_0 < \eta^* < \eta$ .

Now we must expect numerous successive occurrences of the situation under consideration, if it is to be used as a basic procedure. Hence the iterative behavior of the operation  $\eta \rightarrow \eta^* = f_\epsilon(\eta)$  is relevant. Now it is clear from the above, that in the first case the successive iterates of the process in question always converge to  $\frac{1}{2}$ , no matter what the original  $\eta$ : while in the second case these iterates converge to  $\eta_0$  if the original  $\eta < \frac{1}{2}$ , and to  $1 - \eta_0$  if the original  $\eta > \frac{1}{2}$ .

In other words: In the first case no error level other than  $\eta \sim \frac{1}{2}$  can maintain itself in the long run. I.e. the process asymptotically degenerates to total irrelevance,

like the one discussed in 7.1. In the second case the error-levels  $\eta \sim \eta_0$  and  $\eta \sim 1 - \eta_0$  will not only maintain themselves in the long run, but they represent the asymptotic behavior for any original  $\eta < \frac{1}{2}$  or  $\eta > \frac{1}{2}$ , respectively.

These arguments although heuristic, make it clear that the second case alone can be used for the desired error-level control. I.e. we must require  $\eta < \frac{1}{6}$ , i.e. the error-level for a single basic organ function must be less than  $\sim 16\%$ . The stable, ultimate error-level should then be  $\eta_0$  (we postulate, of course, that the start be made with an error-level  $\eta < \frac{1}{2}$ ).  $\eta_0$  is small if  $\epsilon$  is, hence  $\epsilon$  must be small, and so

$$(11) \quad \eta_0 = \epsilon + 3\epsilon^2 + \dots$$

This would therefore give an ultimate error-level of  $\sim 10\%$  (i.e.  $\eta \sim .1$ ) for a single basic organ function error-level of  $\sim 8\%$  (i.e.  $\epsilon \sim .08$ ).

### 8.3.2 The rigorous argument.

To make this heuristic argument binding, it would be necessary to construct an error controlling network  $\mathcal{P}^*$  for any given network  $\mathcal{P}$ , so that all basic organs in it are so connected as to put them into the special case of a majority organ, as discussed above. This will not be uniformly possible, and it will therefore be necessary to modify the above heuristic argument, although its general pattern will be maintained.

It is then desired to find, for any given network  $\mathcal{P}$ , an essentially equivalent network  $\mathcal{P}^*$ , which is error-safe in some suitable sense, that conforms with the ideas expressed so far. We will define this as meaning, that for each output line of  $\mathcal{P}^*$  (corresponding to one of  $(\mathcal{P})$ , the (separate) probability of an incorrect message (over this line) is  $\leq \eta_1$ . The value of  $\eta_1$  will result from the subsequent discussion.

The construction will be an induction over the longest serial chain of basic organs in  $\mathcal{P}$ , say  $\mu = \mu(\mathcal{P})$ .

Consider the structure of  $\mathcal{P}$ . The number of its inputs  $i$  and outputs  $\sigma$  is arbitrary, but every output of  $\mathcal{P}$  must either come from a basic organ in  $\mathcal{P}$ , or directly from an input, or from a ground or live source. Omit the first mentioned basic organs from  $\mathcal{P}$ , as well as the outputs other than the first mentioned ones, and designate the network that is let over by  $\mathcal{Q}$ . This is schematically shown in Figure 28. (Some of the apparently separate outputs of  $\mathcal{Q}$  may be split lines coming from a single one, but this is irrelevant for what follows.)

If  $\mathcal{Q}$  is void, then there is nothing to prove; let therefore  $\mathcal{Q}$  be non-void. Then clearly  $\mu(\mathcal{Q}) = \mu(\mathcal{P}) - 1$ .

Hence the induction permits us to assume the existence of a network  $\mathcal{Q}^*$  which is essentially equivalent to  $\mathcal{Q}$ , and has for each output a (separate) error-probability  $\leq \eta_1$ .

We now provide three copies of  $\mathcal{Q}^* : \mathcal{Q}^{*1}, \mathcal{Q}^{*2}, \mathcal{Q}^{*3}$ , and construct  $\mathcal{Q}^*$  as shown in Figure 29. (Instead of drawing the, rather complicated, connections across the two dotted areas, they are indicated by attaching identical markings to endings that should be connected.)

Now the (separate) output error-probabilities of  $Q^*$  are (by inductive assumption)  $\leq \eta_1$ . The majority organs in the bottom row in Figure 29 (those without a  $\square$ ) are so connected as to belong into the special case for a majority organ (cf. 8.2), hence their outputs have (separate) error-probabilities  $\leq f_\epsilon(\eta_1)$ . The majority organs in the top row in Figure 29 (those with a  $\square$ ) are in the general case, hence their (separate) error-probabilities are  $\leq \epsilon + 3f_\epsilon(\eta_1)$ .

Consequently the inductive step succeeds, and therefore the attempted inductive proof is binding if

$$(12) \quad \epsilon + 3f_\epsilon(\eta_1) \leq \eta_1.$$

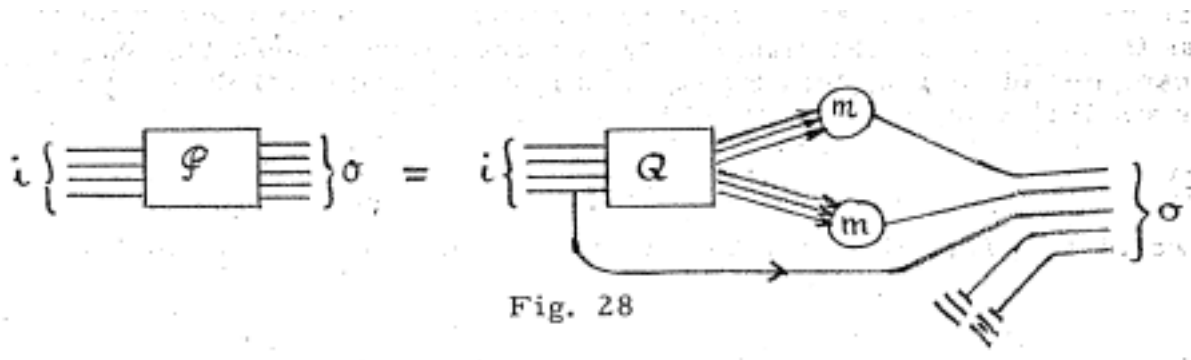

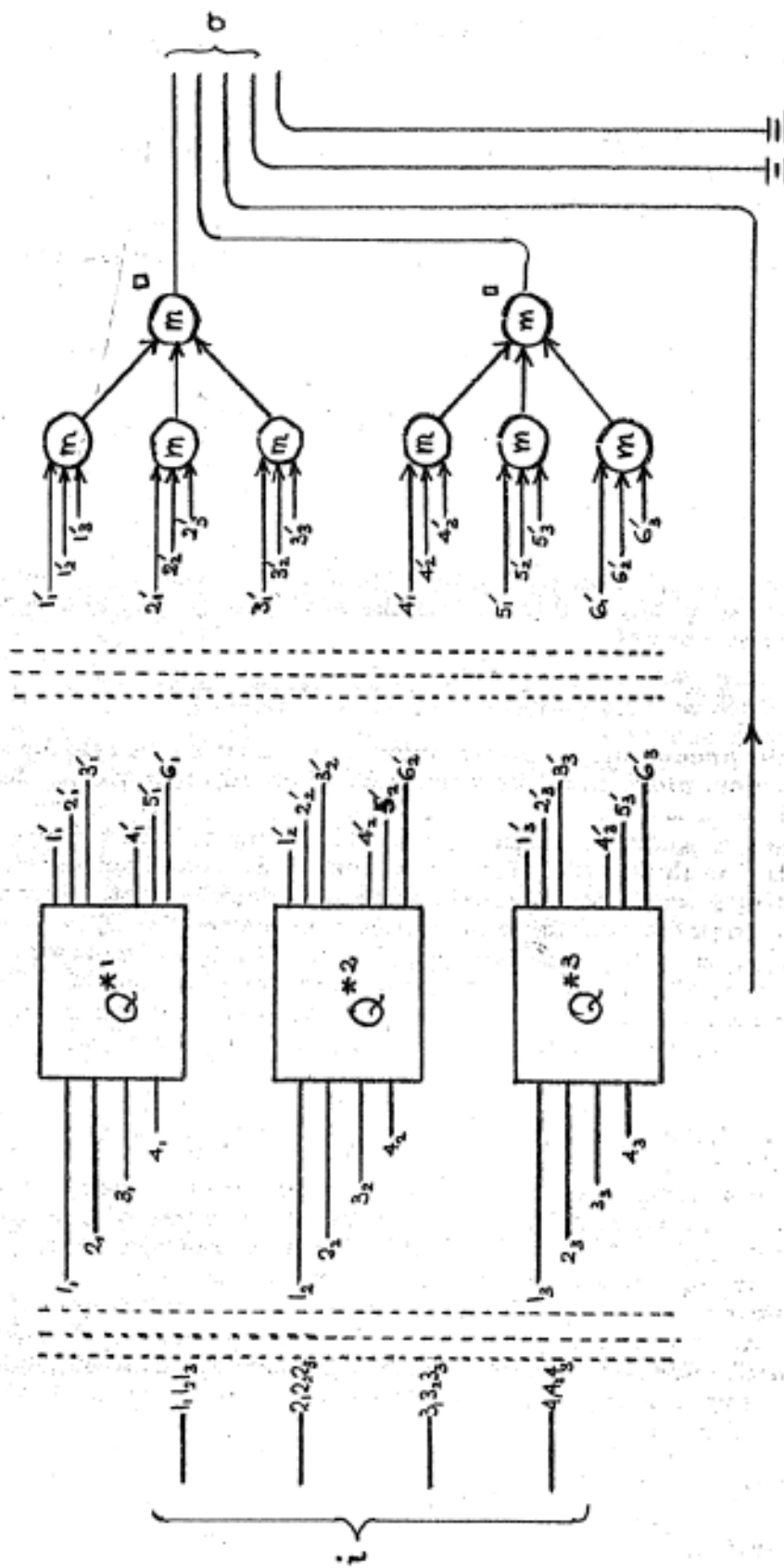

Fig. 29

### 8.4 Numerical evaluation.

Substituting the expression (9) for  $f_\epsilon(\eta)$  into condition (12) gives

$$4\epsilon + 3(1 - 2\epsilon)(3\eta_1^2 - 2\eta_1^3) \leq \eta_1,$$

i.e.

$$\eta_1^3 - \frac{3}{2}\eta_1^2 + \frac{1}{6(1 - 2\epsilon)}\eta_1 - \frac{2\epsilon}{3(1 - 2\epsilon)} \geq 0.$$

Clearly the smallest  $\eta_1 > 0$  fulfilling this condition is wanted. Since the left hand side is  $< 0$  for  $\eta_1 \geq 0$ , this means the smallest (real, and hence, by the above, positive) root of

$$(13) \quad \eta_1^3 - \frac{3}{2}\eta_1^2 + \frac{1}{6(1 - 2\epsilon)}\eta_1 - \frac{2\epsilon}{3(1 - 2\epsilon)} = 0.$$

We know from the preceding heuristic argument, that  $\epsilon \leq \frac{1}{6}$  will be necessary – but actually even more must be required. Indeed, for  $\eta_1 = \frac{1}{2}$  the left hand side of (13) is  $-(1 + \epsilon)/(6 - 12\epsilon) < 0$ , hence a significant and acceptable  $\eta_1$  (i.e. an  $\eta_1 < \frac{1}{2}$ ), can be obtained from (13) only if it has three real roots. A simple calculation shows, that for  $\epsilon = \frac{1}{6}$  only one real root exists  $\eta_1 = 1.425$ . Hence the limiting  $\epsilon$  calls for the existence of a double root. Further calculation shows, that the double root in question occurs for  $\epsilon = .0073$ , and that its value is  $\eta_1 = .060$ . Consequently  $\epsilon < .0073$  is the actual requirement, i.e. the error-level of a single basic organ function must be  $< .73\%$ . The stable, ultimate error-level is then the smallest positive root  $\eta_1$  of (13).  $\eta_1$  is small if  $\epsilon$  is, hence  $\epsilon$  must be small, and so (from (13))

$$\eta_1 = 4\epsilon + 152\epsilon^2 + \dots$$

It is easily seen, that e.g. an ultimate error level of 2% (i.e.  $\eta_1 = .02$ , calls for a single basic organ function error-level of .41% (i.e.  $\epsilon = .0041$ ).

This result shows that errors can be controlled. But the method of construction used in the proof about threefolds the number of basic organs in  $\mathcal{P}^*$  for an increase of  $\mu(\mathcal{P})$  by 1, hence  $\mathcal{P}^*$  has to contain about  $3^{\mu(\mathcal{P})}$  such organs. Consequently the procedure is impractical.

The restriction  $\epsilon < .0073$  has no absolute significance. It could be relaxed by iterating the process of triplication at each step. The inequality  $\epsilon < \frac{1}{6}$  is essential, however, since our first argument showed, that for  $\epsilon \geq \frac{1}{6}$  even for a basic organ in the most favorable situation (namely in the “special” one) no interval of improvement exists.

## 9. THE TECHNIQUE OF MULTIPLEXING.

### 9.1 General remarks on multiplexing.

The general process of multiplexing in order to control error was already referred to in 7.4 (p. 22). The messages are carried on  $N$  lines. A positive number  $\Delta (< \frac{1}{2})$  is chosen and the stimulation of  $\geq (1 - \Delta)N$  lines of the bundle is interpreted as a positive message, the stimulation of  $\leq \delta N$  lines as a negative message. Any other number of stimulated lines is interpreted as malfunction. The complete system must be organized in such a manner, that a malfunction of the whole automaton cannot be caused by the malfunctioning of a single component, or of a small number of components, but only by the malfunctioning of a large number of them. As we will see later, the probability of such occurrences can be made arbitrarily small provided the number of lines in each bundle is made sufficiently great. All of Section 9 will be devoted to a description of the method of constructing multiplexed automata and its discussion, without considering the possibility of error in the basic components. In Section 10 (p. 37) we will then introduce errors in the basic components, and estimate their effects.

### 9.2 The majority organ.

#### 9.2.1 The basic executive organ.

The first thing to consider is the method of constructing networks which will perform the tasks of the basic organs for bundles of inputs and outputs instead of single lines.

A simple example will make the process clear: Consider the problem of constructing the analogue of the majority organ which will accommodate bundles of five lines. This is, easily done using the ordinary majority organ of Figure 14 (p. 13), as shown in Figure 30. (The connections are replaced by suitable markings, in the same way as in Figure 29 (p. 28)).

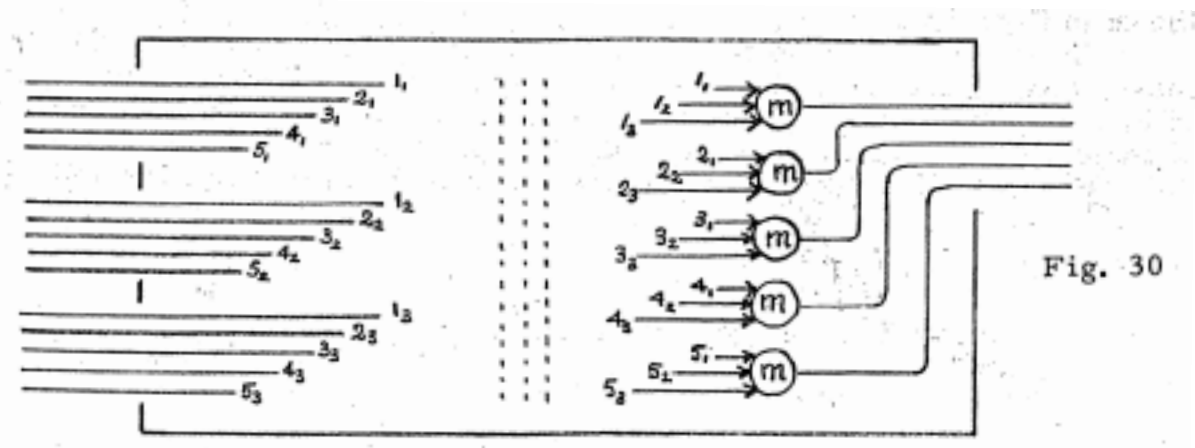

Fig. 30

### 9.2.2 The need for a restoring organ.

It is intuitively clear that if almost all lines of the input bundles are stimulated, then almost all lines of the output bundle will be stimulated. Similarly if almost none of the lines of two of the input bundles are stimulated, then the mechanism will stimulate almost none of its output lines. However, another fact is brought to light. Suppose that a critical level  $\Delta = 1/5$  is set for the bundles. Then if two of the input bundles have 4 lines stimulated while the other has none, the output may have only 3 lines stimulated. The same effect prevails in the negative case. If two bundles have just one input each stimulated, while the third bundle has all of its inputs stimulated, then the resulting output may be the stimulation of two lines. In other words, the relative number of lines in the bundle, which are not in the majority state, can double in passing through the generalized majority system. A more careful analysis (similar to the one that will be gone into in more detail for the case of the Scheffer organ in Section 10 (p. 37)) shows the following: If, in some situation, the operation of the organ should be governed by a two-to-one majority of the input bundles (i.e. if two of the bundles are both prevalently stimulated or both prevalently non-stimulated, while the third one is in the opposite condition), then the most probable level of the output error will be (approximately) the sum of the errors in the two governing input bundles; on the other hand in an operation in which the organ is governed by a unanimous behavior of its input bundles (i.e. if all three of the bundles are prevalently stimulated or all three are prevalently non-stimulated), then the output error will generally be smaller than the (maximum of the) input errors. Thus in the significant case of two-to-one majorization, two significant inputs may combine to produce a result lying in the intermediate region of uncertain information. What is needed therefore is a new type of organ which will restore the original stimulation level. In other words, we need a network having the property that, with a fairly high degree of probability, it transforms an input bundle with a stimulation level which is near to zero or to one into an output bundle with stimulation level which is even closer to the corresponding extreme.

Thus the multiplexed systems must contain two types of organs. The first type is the executive organ which performs the desired basic operations on the bundles. The second type is an organ which restores the stimulation level of the bundles, and hence erases the degradation caused by the executive organs. This situation has its analog in many of the real automata which perform logically complicated tasks. For example in electrical circuits, some of the vacuum tubes perform executive functions, such as detection or rectification or gating or coincidence-sensing, while the remainder are assigned the task of amplification, which is a restorative operation.

### 9.2.3 The restoring organ.

#### 9.2.3.1 Construction.

The construction of a restoring organ is quite simple in principle, and in fact contained in the second remark made in 9.2.2. In a crude way, the ordinary majority organ

already performs this task. Indeed in the simplest case, for a bundle of three lines, the majority organ has precisely the right characteristics: It suppresses a single incoming impulse as well as a single incoming non-impulse, i.e. it amplifies the prevalence of the presence as well as of the absence of impulses. To display this trait most clearly, it suffices to split its output line into three lines, as shown in Figure 31.

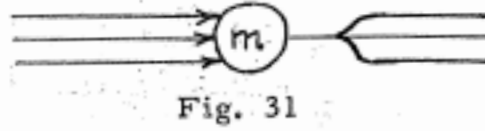

Fig. 31

Now for large bundles, in the sense of the remark referred to above, concerning the reduction of errors in the case of a response induced by a unanimous behavior of the input bundles, it is possible to connect up majority organs in parallel and thereby produce the desired restoration. However, it is necessary to assume that the stimulated (or non-stimulated) lines are distributed at random in the bundle. This randomness must then be maintained at all times. The principle is illustrated by Figure 32. The “black box”  $\mathcal{U}$  is supposed to permute the lines of the input bundle that pass through it, so as to restore the randomness of the pulses in its lines. This is necessary, since to the left of  $\mathcal{U}$  the input bundle consists of a set of triads, where the lines of each triad originate in the splitting of a single line, and hence are always all three in the same condition. Yet, to the right of  $\mathcal{U}$  the lines of the corresponding triad must be statistically independent, in order to permit the application of the statistical formula to be given below for the functioning of the majority organ into which they feed. The way to select such a “randomizing” permutation will not be considered here – it is intuitively plausible that most “complicated” permutations will be suited for this “randomizing” role. (cf. 11.2.)

### 9.2.3.2 Numerical evaluation.

If  $\alpha\mathcal{N}$  of the  $\mathcal{N}$  incoming lines are stimulated, then the probability of any majority organ being stimulated (by two or three stimulated inputs) is

$$(14) \quad \alpha^* = 3\alpha^2 - 2\alpha^3 \equiv g(\alpha).$$

Thus approximately (i.e. with high probability, provided  $\mathcal{N}$  is large)  $\alpha^*\mathcal{N}$  outputs will be excited. Plotting the curve of  $\alpha^*$  against  $\alpha$ , as shown in Figure 33, indicates clearly that this organ will have the desired characteristics:

This curve intersects the diagonal  $\alpha^* = \alpha$  three times: For  $\alpha = 0, \frac{1}{2}, 1$ .  $0 < \alpha < \frac{1}{2}$  implies  $0 < \alpha^*, \alpha$ ;  $\frac{1}{2} < \alpha < 1$  implies  $\alpha < \alpha^*, 1$ . I.e. successive iterates of this process converge to 0 if the original  $\alpha < \frac{1}{2}$  and to 1 if the original  $\alpha > \frac{1}{2}$ .

In other words: The error levels  $\alpha \sim 0$  and  $\alpha \sim 1$  will not only maintain themselves in the long run but they represent the asymptotic behavior for any original  $\alpha < \frac{1}{2}$  or  $\alpha > \frac{1}{2}$  respectively. Note, that because of  $g(1 - \alpha) \equiv 1 - g(\alpha)$  there is complete symmetry between the  $\alpha < \frac{1}{2}$  region and the  $\alpha > \frac{1}{2}$  region.



The process  $\alpha \rightarrow \alpha^*$  thus brings every  $\alpha$  nearer to that one of 0 and 1, to which it was nearer originally. This is precisely that process of restoration, which was seen in 9.2.2 to be necessary. I.e. one or more (successive) applications of this process will have the required restoring effect.

Note that this process of restoration is most effective when  $\alpha - \alpha^* = 2\alpha^3 - 3\alpha^2 + \alpha$  has its minimum or maximum, i.e. for

$$6\alpha^2 - 6\alpha + 1 = 0, \text{ i.e. for } \alpha = (3 \pm \sqrt{5})/6 = .788, .212.$$

Then  $\alpha - \alpha^* = \pm .096$ . I.e. the maximum restoration is effected on error levels at the distance of 21.2% from 0% or 100% – these are improved (brought nearer) by 9.6%.

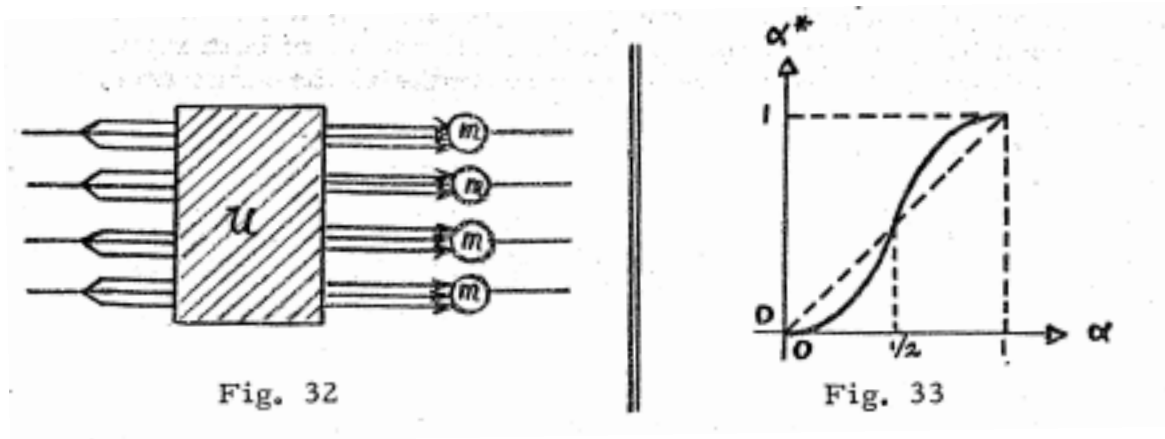

### 9.3 Other basic organs.

We have so far assumed that the basic components of the construction are majority organs. From these, an analogue of the majority organ – one which picked out a majority of bundles instead of a majority of single lines – was constructed. Since this, when viewed as a basic organ, is a universal organ, these considerations show that it is at least theoretically possible to construct any network with bundles instead of single lines. However there was no necessity for starting from majority organs. Indeed, any other basic system whose universality was established in Section 4 can be used instead. The simplest procedure in such a case is to construct an (essential) equivalent of the (single line) majority organ from the given basic system (cf. 4.2.2 (p. 13)), and then proceed with this composite majority organ in the same way as was done above with the basic majority organ.

Thus, if the basic organs are those Nos. one and two in Figure 10 (p. 10) (cf. the relevant discussion in 4.1.2 (p. 9), then the basic synthesis (that of the majority organ, cf. above) is immediately derivable from the introductory formula of Figure 14 (p. 13).

## 9.4 The Scheffer stroke.

### 9.4.1 The executive organ.

Similarly, it is possible to construct the entire mechanism starting from the Scheffer organ of Figure 12. In this case, however, it is simpler not to effect the passage to an (essential) equivalent of the majority organ (as suggested above), but to start *de novo*. Actually, the same procedure, which was seen above to work for the majority organ, works *mutatis mutandis* for the Scheffer organ, too. A brief description of the direct procedure in this case is given in what follows:

Again, one begins by constructing a network which will perform the task of the Scheffer organ for bundles of inputs and outputs instead of single lines. This is shown in Figure 34 for bundles of five wires. (The connections are replaced by suitable markings, as in Figure 29 and 30.)

It is intuitively clear that if almost all lines of both input bundles are stimulated, then almost none of the lines of the output bundle will be stimulated. Similarly, if almost none of the lines of one input bundle are stimulated, then almost all lines of the output bundle will be stimulated. In addition to this overall behavior, the following detailed behavior is found (cf. the detailed consideration in 10.4 (p. 42)). If the condition of the organ is one of prevalent non-stimulation of the output bundle, and hence is governed by (prevalent stimulation of) both input bundles, then the most probable level of the output error will be (approximately) the sum of the errors in the two governing input bundles; if on the other hand the condition of the organ is one of prevalent stimulation of the output bundle, and hence is governed by (prevalent non-stimulation of) one or of both input bundles, then the output error will be on (approximately) the same level as the input error, if (only) one input bundle is governing (i.e. prevalently non-stimulated), and it will be generally smaller than the input error, if both input bundles were governing (i.e. prevalently non-stimulated). Thus two significant inputs may produce a result lying in the intermediate zone of uncertain information. Hence a restoring organ (for the error level) is again needed, in addition to the executive organ.

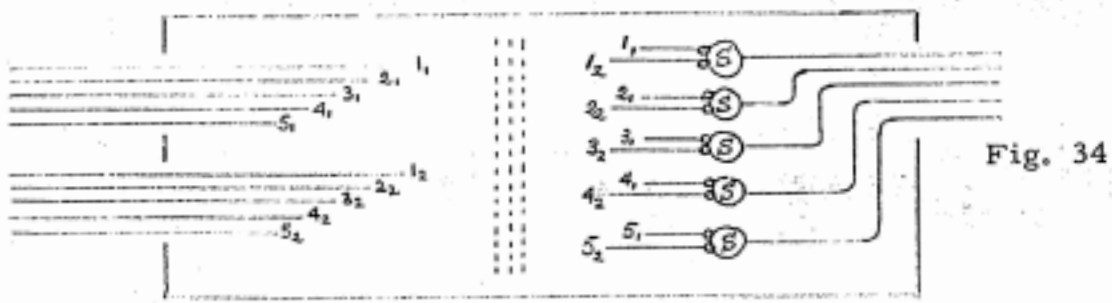

9.4.2 The restoring organ.

Again the above indicates that the restoring organ can be obtained from a special case functioning of the standard executive organ, namely by obtaining all inputs from a single input bundle, and seeing to it that the output bundle has the same size as the original input bundle. The principle is illustrated by Figure 35. “The black box”  $\mathcal{U}$  is again supposed to effect a suitable permutation of the lines that pass through it, for the same reasons and in the same manner as in the corresponding situation for the majority organ (cf. Figure 32). I.e. it must have a “randomizing” effect.

If  $\alpha\mathcal{N}$  of the  $\mathcal{N}$  incoming lines are stimulated, then the probability of any Scheffer organ being stimulated (by at least one non-stimulated input) is

$$(15) \quad \alpha^+ = 1 - \alpha^2 \equiv h(\alpha).$$

Thus approximately (i.e. with high probability provided  $\mathcal{N}$  is large)  $\sim \alpha^+\mathcal{N}$  outputs will be excited. Plotting the curve, of  $\alpha^+$  against  $\alpha$  discloses some characteristic differences against the previous case (that one of the majority organs, i.e.  $\alpha^* = 3\alpha^2 - 2\alpha^3 \equiv g(\alpha)$ , cf. 9.2.3), which require further discussion. This curve is shown in Figure 36. Clearly  $\alpha^+$  is an antimonotone function of  $\alpha$ , i.e. instead of restoring an excitation level (i.e. bringing it closer to 0 or to 1, respectively), it transforms it into its opposite (i.e. it brings the neighborhood of 0 close to 1, and the neighborhood of 1 close to 0). In addition it produces for  $\alpha$  near to 1 an  $\alpha^+$  less near to 0 (about twice farther), but for  $\alpha$  near to 0  $\alpha^+$  much nearer to 1 (second order!). All these circumstances suggest that the operation should be iterated.

Let the restoring organ therefore consist of two of the previously pictured organs in series, as shown in Figure 37. (The “black boxes”  $\mathcal{U}_1, \mathcal{U}_2$  play the same role as their analog  $\mathcal{U}$  plays in Figure 35.) This organ transforms an input excitation level  $\alpha\mathcal{N}$  into an output excitation level of approximately (cf. above)  $\sim \alpha^{++}$  where

$$\alpha^{++} = 1 - (1 - \alpha^2)^2 \equiv h(h(\alpha)) \equiv k(\alpha),$$

i.e.

$$(16) \quad \alpha^{++} = 2\alpha^2 - \alpha^4 \equiv k(\alpha),$$

This curve of  $\alpha^{++}$  against  $\alpha$  is shown in Figure 38. This curve is very similar to that one obtained for the majority organ (i.e.  $\alpha^* = 3\alpha^2 - 2\alpha^3 \equiv g(\alpha)$ , (cf. 9.2.3). Indeed: The curve intersects the diagonal  $\alpha^{++} = \alpha$  in the interval  $0 \leq \alpha^{++} \leq 1$  three times: For  $\alpha = 0, \alpha_0, 1$ , where  $\alpha_0 = (-1 + \sqrt{5})/2 = .618$ . (There is a fourth intersection  $\alpha = -1 - \alpha_0 = -1.618$ , but this is irrelevant, since it is not in the interval  $0 \leq \alpha \leq 1$ .)  $0 < \alpha < \alpha_0$  implies  $0 < \alpha^{++} < \alpha$ ;  $\alpha_0 < \alpha < 1$  implies  $\alpha < \alpha^{++} < 1$ .

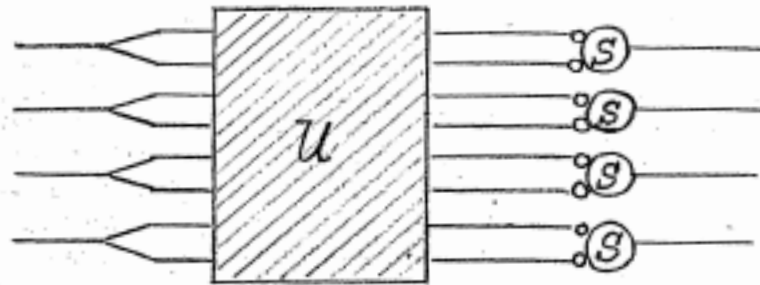

Fig. 35

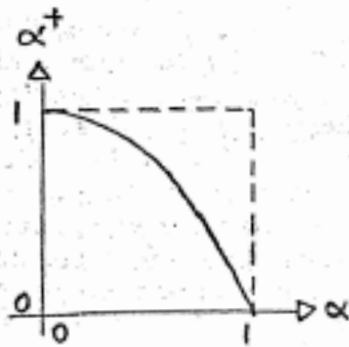

Fig. 36

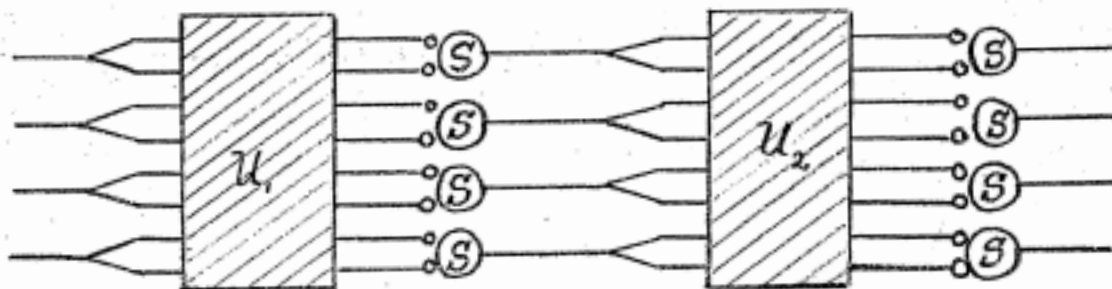
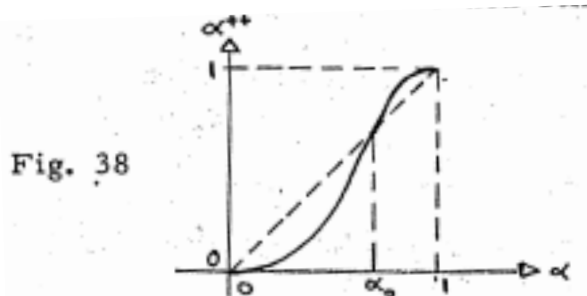

Fig. 37



In other words: The role of the error levels  $\alpha \sim 0$  and  $\alpha \sim 1$  is precisely the same as for the majority organ (cf. 9.2.3), except that the limit between their respective areas of control lies at  $\alpha = \alpha_0$  instead of at  $\alpha = \frac{1}{2}$ . I.e. the process  $\alpha \rightarrow \alpha^{++}$  brings every  $\alpha$  nearer to either 0 or to 1, but the preference to 0 or to 1, is settled at a discrimination level of 61.8% (i.e.  $\alpha_0$ ) instead of one of 50% (i.e.  $\frac{1}{2}$ ). Thus, apart from a certain asymmetric distortion, the organ behaves like its counterpart considered for the majority organ – i.e. is an effective restoring mechanism.

## 10. ERROR IN MULTIPLEX SYSTEMS.

### 10.1 General remarks.

In Section 9 (p. 30) the technique for constructing multiplexed automata was described. However the role of errors entered at best intuitively and summarily, and therefore it has still not been proved that these systems will do what is claimed for them – namely control error. Section 10 is devoted to a sketch of the statistical analysis necessary to show that, by using large enough bundles of lines, any desired degree of accuracy (i.e. as small a probability of malfunction of the ultimate output of the network as desired) can be obtained with a multiplexed automaton.

For simplicity, we will only consider automata which are constructed from the Scheffer organs. These are easier to analyze since they involve only two inputs. At the same time, the Scheffer organ is (by itself) universal (cf. 4.2.1 (p. 12)), hence every automaton is essentially equivalent to a network of Scheffer organs.

Errors in the operation of an automaton arise from two sources. First, the individual basic organs can make mistakes. It will be assumed as before, that, under any circumstance, the probability of this happening is just  $\epsilon$ . Any operation on the bundle can be considered as a random sampling of size  $\mathcal{N}$  ( $\mathcal{N}$  being the size of the bundle). The number of errors committed by the individual basic organs in any operation on the bundle is then a random variable, distributed approximately normally with mean  $\epsilon\mathcal{N}$  and standard deviation  $\sqrt{\epsilon(1-\epsilon)\mathcal{N}}$ . A second source of failures arises because in operating with bundles which are not all in the same state of stimulation or non-stimulation, the possibility of multiplying error by unfortunate combinations of lines into the basic (single line) organs is always present. This interacts with the statisti-

cal effects, and in particular with the processes of degeneration and of restoration of which we spoke in 9.2.2, 9.2.3 and 9.4.2.

## 10.2 The distribution of the response set size.

### 10.2.1 Exact theory.

In order to give a statistical treatment of the problem, consider the Figure 34 (p. 34), showing a network of Scheffer organs, which was discussed in 9.4.1. Let again  $\mathcal{N}$  be the number of lines in each (input or output) bundle. Let  $\mathcal{X}$  be the set of those  $i = 1, \dots, \mathcal{N}$  for which line No.  $i$  in the first input bundle is stimulated at time  $t$ ; let  $\mathcal{Y}$  be the corresponding set for the second input bundle at time  $t$ ; and let  $\mathcal{Z}$  be the corresponding set for the output bundle, assuming the correct functioning of all the Scheffer organs involved, at time  $t + 1$ . Let  $\mathcal{X}, \mathcal{Y}$  have  $\xi\mathcal{N}, \eta\mathcal{N}$  elements, respectively, but otherwise be random – i.e. equidistributed over all pairs of sets with these numbers of elements. What can then be said about the number of elements  $\zeta\mathcal{N}$  of  $\mathcal{Z}$ ? Clearly  $\xi, \eta, \zeta$  are the relative levels of excitation of the two input bundles and of the output bundle, respectively, of the network under consideration. The question is then: what is the distribution of the (stochastic) variable  $\zeta$  in terms of the (given)  $\xi, \eta$ ?

Let  $\mathcal{W}$  be the complimentary set of  $\mathcal{Z}$ . Let  $p, q, r$  be the numbers of elements of  $\mathcal{X}, \mathcal{Y}, \mathcal{W}$ , respectively, so that  $p = \xi\mathcal{N}, q = \eta\mathcal{N}, r = (1 - \zeta)\mathcal{N}$ . Then the problem is to determine the distribution of the (stochastic) variable  $r$  in terms of the (given)  $p, q$  – i.e. the probability of any given  $r$  in combination with any given  $p, q$ .

$\mathcal{W}$  is clearly the intersection of the sets  $\mathcal{X}, \mathcal{Y}$ :  $\mathcal{W} = \mathcal{X} \cdot \mathcal{Y}$ . Let  $\mathcal{U}, \mathcal{V}$  be the (relative) complements of  $\mathcal{W}$  in  $\mathcal{X}, \mathcal{Y}$  respectively:  $\mathcal{U} = \mathcal{X} - \mathcal{W}, \mathcal{V} = \mathcal{Y} - \mathcal{W}$ , and let  $\mathcal{S}$  be the (absolute, i.e. in the set  $(1, \dots, \mathcal{N})$ ) complement of the sum of  $\mathcal{X}$  and  $\mathcal{Y}$ :  $\mathcal{S} = -(\mathcal{X} + \mathcal{Y})$ . Then  $\mathcal{W}, \mathcal{U}, \mathcal{V}, \mathcal{S}$  are pairwise disjoint sets making up together precisely the entire set  $(1, \dots, \mathcal{N})$ , with  $r, p - r, q - r, \mathcal{N} - p - q + r$  elements, respectively. Apart from this they are unrestricted. Thus they offer together  $\mathcal{N}!/[r!(p - r)!(q - r)!(\mathcal{N} - p - q + r)!]$  possible choices. Since there are *a priori*  $\mathcal{N}!/[p!(\mathcal{N} - p)!]$  possible choices of an  $\mathcal{X}$  with  $p$  elements and *a priori*  $\mathcal{N}!/[q!(\mathcal{N} - q)!]$  possible choices of a  $\mathcal{Y}$  with  $q$  elements, this means that the looked for probability of  $\mathcal{W}$  having  $r$  elements is

$$\begin{aligned} \varrho &= \left( \frac{\mathcal{N}!}{r!(p - r)!(q - r)!(\mathcal{N} - p - q + r)!} \right) / \left( \frac{\mathcal{N}!}{p!(\mathcal{N} - p)!} \frac{\mathcal{N}!}{q!(\mathcal{N} - q)!} \right) \\ &= \frac{p!(\mathcal{N} - p)!q!(\mathcal{N} - q)!}{r!(p - r)!(q - r)!(\mathcal{N} - p - q + r)!\mathcal{N}!}. \end{aligned}$$

Note that this formula also shows that  $\varrho = 0$  when  $r < 0$  or  $p - r < 0$  or  $q - r < 0$  or  $\mathcal{N} - p - q + r < 0$ , i.e. when  $r$  violates the conditions

$$\max(0, p + q - \mathcal{N}) \leq r \leq \min(p, q).$$

This is clear combinatorially, in view of the meaning of  $\mathcal{X}, \mathcal{Y}$  and  $\mathcal{W}$ . In terms of  $\xi, \eta, \zeta$  the above conditions become

$$(17) \quad 1 - \max(0, \xi + \eta - 1) \geq \zeta \geq 1 - \min(\xi, \eta).$$

Returning to the expression for  $\varrho$ , substituting the  $\xi, \eta, \zeta$  expressions for  $p, q, r$  and using Stirling's formula for the factorials involved, gives

$$(18) \quad \varrho \sim \frac{1}{\sqrt{2\pi\mathcal{N}}} \sqrt{\alpha} e^{-\theta\mathcal{N}},$$

where

$$\begin{aligned} \alpha &= \frac{\xi(1-\zeta)\eta(1-\eta)}{(\zeta+\xi-1)(\zeta+\eta-1)(1-\zeta)(2-\xi-\eta-\zeta)}, \\ \theta &= (\zeta+\xi-1)\ln(\zeta+\xi-1) + (\zeta+\eta-1)\ln(\zeta+\eta-1) \\ &\quad + (1-\zeta)\ln(1-\zeta) + (2-\xi-\eta-\zeta)\ln(2-\xi-\eta-\zeta) \\ &\quad - \xi\ln\xi - (1-\xi)\ln(1-\xi) - \eta\ln\eta - (1-\eta)\ln(1-\eta). \end{aligned}$$

From this

$$\begin{aligned} \frac{\partial\theta}{\partial\zeta} &= \ln \frac{(\zeta+\xi-1)(\zeta+\eta-1)}{(1-\zeta)(2-\xi-\eta-\zeta)}, \\ \frac{\partial^2\theta}{\partial\zeta^2} &= \frac{1}{\zeta+\xi-1} + \frac{1}{\zeta+\eta-1} + \frac{1}{1-\zeta} + \frac{1}{2-\xi-\eta-\zeta}. \end{aligned}$$

Hence  $\theta = 0$ ,  $\frac{\partial\theta}{\partial\zeta} = 0$  for  $\zeta = 1 - \xi\eta$ , and  $\frac{\partial^2\theta}{\partial\zeta^2} > 0$  for all  $\zeta$  (in its entire interval of variability according to (17)). Consequently  $\theta > 0$  for all  $\zeta \neq 1 - \xi\eta$  (within the interval (17)). This implies, in view of (18), that for all  $\zeta$  which are significantly  $\neq 1 - \xi\eta$ ,  $\varrho$  tends to 0 very rapidly as  $\mathcal{N}$  gets large. It suffices therefore to evaluate (18) for  $\zeta \sim 1 - \xi\eta$ . Now  $\alpha = 1/[\xi(1-\xi)\eta(1-\eta)]$ ,  $\frac{\partial^2\theta}{\partial\zeta^2} = 1/[\xi(1-\xi)\eta(1-\eta)]$  for  $\zeta = 1 - \xi\eta$ . Hence

$$\begin{aligned} \alpha &\sim \frac{1}{\xi(1-\xi)\eta(1-\eta)}, \\ \theta &\sim \frac{(\xi - (1 - \xi\eta))^2}{2\xi(1-\xi)\eta(1-\eta)} \end{aligned}$$

for  $\zeta \sim 1 - \xi\eta$ . Therefore

$$(19) \quad \varrho \sim \frac{1}{\sqrt{2\pi\xi(1-\xi)\eta(1-\eta)\mathcal{N}}} e^{-\frac{\xi-(1-\xi\eta)}{2\xi(1-\xi)\eta(1-\eta)}\mathcal{N}}$$

is an acceptable approximation for  $\varrho$ .

$r$  is an integer-valued variable, hence  $\zeta = 1 - \frac{r}{\mathcal{N}}$  is a rational valued variable, with the fixed denominator  $\mathcal{N}$ . Since  $\mathcal{N}$  is assumed to be very large, the range of  $\zeta$  is very dense. It is therefore permissible to replace it by a continuous one, and to describe the distribution of  $\zeta$  by a probability-density  $\sigma$ .  $\varrho$  is the probability of a single value of

$\zeta$ , and since the values of  $\zeta$  are equidistant, with a separation  $d\zeta = 1/\mathcal{N}$ , the relation between  $\sigma$  and  $\varrho$  is best defined by  $\sigma d\zeta = \varrho$ , i.e.  $\sigma = \varrho\mathcal{N}$ . Therefore (19) becomes

$$(20) \quad \sigma \sim \frac{1}{\sqrt{2\pi}\sqrt{\xi(1-\xi)\eta(1-\eta)}/\mathcal{N}} e^{-\frac{1}{2}\left(\frac{\zeta-(1-\xi\eta)}{\sqrt{\xi(1-\xi)\eta(1-\eta)}/\mathcal{N}}\right)^2}.$$

This formula means obviously the following:

$\zeta$  is approximately normally distributed, with the mean  $1 - \xi\eta$  and the dispersion  $\sqrt{\xi(1-\xi)\eta(1-\eta)}/\mathcal{N}$ . Note, that the rapid decrease of the normal distribution function (i.e. the right hand side of (20) with  $\mathcal{N}$  (which is exponential!) is valid as long as  $\zeta$  is near to  $1 - \xi\eta$ , only the coefficient of  $\mathcal{N}$  (in the exponent, i.e.  $-\frac{1}{2}\left([\zeta - (1 - \xi\eta)]/\sqrt{\xi(1-\xi)\eta(1-\eta)}/\mathcal{N}\right)^2$ ) is somewhat altered as  $\zeta$  deviates from  $1 - \xi\eta$ . (This follows from the discussion of  $\theta$  given above.)

The simple statistical discussion of 9.4 amounted to attributing to  $\zeta$  the unique value  $1 - \xi\eta$ . We see now that this is approximately true:

$$(21) \quad \begin{cases} \zeta &= (1 - \xi\eta) + \sqrt{\xi(1-\xi)\eta(1-\eta)}/\mathcal{N} \delta, \\ \delta &\text{is a stochastic variable, normally distributed, with mean 0} \\ &\text{and dispersion 1.} \end{cases}$$

### 10.2.2 Theory with errors.

We must now pass from  $r, \zeta$ , which postulate faultless functioning of all Scheffer organs in the network, to  $r', \zeta'$ , which correspond to the actual functioning of all these organs – i.e. to a probability  $\epsilon$  of error on each functioning. Among the  $\mathcal{N} - r$  organs each of which should correctly stimulate its output, each error reduces  $r'$  by one unit. The number of errors here is approximately normally distributed, with the mean  $\epsilon r$  and the dispersion  $\sqrt{\epsilon(1-\epsilon)r}$  (cf. the remark made in 10.1 (p. 37)). Among the  $\mathcal{N} - r$  organs, each of which should correctly not stimulate its output, each error increases  $r'$  by one unit. The number of errors here is again approximately normally distributed, with the mean  $\epsilon(\mathcal{N} - r)$  and the dispersion  $\sqrt{\epsilon(1-\epsilon)(\mathcal{N} - r)}$  (cf. as above). Thus  $r' - r$  is the difference of these two (independent) stochastic variables. Hence it, too, is approximately normally distributed, with the mean  $-\epsilon r + \epsilon(\mathcal{N} - r) = \epsilon(\mathcal{N} - 2r)$ , and the dispersion

$$\sqrt{\left(\sqrt{\epsilon(1-\epsilon)r}\right)^2 + \left(\sqrt{\epsilon(1-\epsilon)(\mathcal{N} - r)}\right)^2} = \sqrt{\epsilon(1-\epsilon)\mathcal{N}}.$$

I.e. (approximately)

$$r' = r + 2\epsilon\left(\frac{\mathcal{N}}{2} - r\right) + \sqrt{\epsilon(1-\epsilon)\mathcal{N}} \delta',$$

where  $\delta'$  is normally distributed with the mean 0 and the dispersion 1. From this

$$\zeta' = \zeta + 2\epsilon\left(\frac{1}{2} - \zeta\right) + \sqrt{\epsilon(1-\epsilon)\mathcal{N}} \delta',$$



and then by (21)

$$\begin{aligned} \zeta' = & (1 - \xi\eta) + 2\epsilon(\xi\eta - \frac{1}{2}) \\ & + (1 - 2\epsilon)\sqrt{\xi(1 - \xi)\eta(1 - \eta)/\mathcal{N}} \delta \\ & - \sqrt{\epsilon(1 - \epsilon)/\mathcal{N}}. \end{aligned}$$

Clearly  $(1 - 2\epsilon)\sqrt{\xi(1 - \xi)\eta(1 - \eta)/\mathcal{N}} \delta - \sqrt{\epsilon(1 - \epsilon)/\mathcal{N}} \delta'$ , too, is normally distributed, with the mean 0 and the dispersion

$$\begin{aligned} & \sqrt{\left((1 - 2\epsilon)\sqrt{\xi(1 - \xi)\eta(1 - \eta)/\mathcal{N}}\right)^2 + \left(\sqrt{\epsilon(1 - \epsilon)/\mathcal{N}}\right)^2} \\ = & \sqrt{\left((1 - 2\epsilon)^2\xi(1 - \xi)\eta(1 - \eta) + \epsilon(1 - \epsilon)\right)/\mathcal{N}}. \end{aligned}$$

Hence (21) becomes at last (we write again  $\zeta$  in place of  $\zeta'$ ):

$$(22) \quad \left\{ \begin{array}{l} \zeta = (1 - \xi\eta) + 2\epsilon(\xi\eta - \frac{1}{2}) \\ \quad + \sqrt{\left((1 - 2\epsilon)^2\xi(1 - \xi)\eta(1 - \eta)\right)/\mathcal{N}} \delta^*, \\ \delta^* \text{ is a stochastic variable, normally distributed, with} \\ \quad \text{the mean 0 and the dispersion 1.} \end{array} \right.$$

### 10.3 The restoring organ.

This discussion equally covers the situations that are dealt with in Figures 35 and 37 (p. 36), showing networks of Scheffer organs in 9.4.2 (p. 34).

Consider first Figure 35. We have here a single input bundle of  $\mathcal{N}$  lines, and an output bundle of  $\mathcal{N}$  lines. However, the two-way split and the subsequent “randomizing” permutation produce an input bundle of  $2\mathcal{N}$  lines and (to the right of  $\mathcal{U}$ ) the even lines of this bundle on one hand, and its odd lines on the other hand, may be viewed as two input bundles of  $\mathcal{N}$  lines each. Beyond this point the network is the same as that one of Figure 34 (p. 34), discussed in 9.4.1 (p. 34). If the original input bundle had  $\xi\mathcal{N}$  stimulated lines, then each one of the two derived input bundles will also have  $\xi\mathcal{N}$  stimulated lines. (To be sure of this, it is necessary to choose the “randomizing” permutation  $\mathcal{U}$  of Figure 35 in such a manner, that it permutes the even lines among each other, and the odd lines among each other. This is compatible with its “randomizing” the relationship of the family of all even lines to the family of all odd lines. Hence it is reasonable to expect that this requirement does not conflict with the desired randomizing character of the permutation.) Let the output bundle have  $\zeta\mathcal{N}$  stimulated lines. Then we are clearly dealing with the same case as in (22),

except that it is specialized to  $\xi = \eta$ . Hence (22) becomes:

$$(23) \quad \left\{ \begin{array}{l} \zeta = \frac{(1 - \xi^2) + 2\epsilon(\xi^2 - \frac{1}{2})}{+ \sqrt{\left((1 - 2\epsilon)^2(\xi(1 - \xi))^2 + \epsilon(1 - \epsilon)\right)} / \mathcal{N} \delta^*} \\ \delta^* \text{ is a stochastic variable, normally distributed, with the mean 0} \\ \text{and the dispersion 1.} \end{array} \right.$$

Consider next Figure 37 (p. 36). Three bundles are relevant here: The input bundle at the extreme left, the intermediate bundle issuing directly from the first tier of Scheffer organs, and the output bundle issuing directly from the second tier of Scheffer organs, i.e. at the extreme right. Each one of these three bundles consists of  $\mathcal{N}$  lines. Let the number of stimulated lines in each bundle be  $\zeta\mathcal{N}, \omega\mathcal{N}, \psi\mathcal{N}$ , respectively. Then (23) above applies, with its  $\xi, \zeta$  replaced first by  $\zeta, \omega$ , and second by  $\omega, \psi$ :

$$(24) \quad \left\{ \begin{array}{l} \omega = \frac{(1 - \zeta^2) + 2\epsilon(\zeta^2 - \frac{1}{2})}{+ \sqrt{\left((1 - 2\epsilon)^2(\zeta(1 - \zeta))^2 + \epsilon(1 - \epsilon)\right)} / \mathcal{N} \delta^{**}}, \\ \psi = \frac{(1 - \omega^2) + 2\epsilon(\omega^2 - \frac{1}{2})}{+ \sqrt{\left((1 - 2\epsilon)^2(\omega(1 - \omega))^2 + \epsilon(1 - \epsilon)\right)} / \mathcal{N} \delta^{***}}, \\ \delta^{**}, \delta^{***} \text{ are stochastic variables, independently and normally} \\ \text{distributed, with the mean 0 and the dispersion 1.} \end{array} \right.$$

## 10.4 Qualitative evaluation of the results.

In what follows, (22) and (24) will be relevant – i.e. the Scheffer organ networks of Figures 34 and 37.

Before going into these considerations however, we have to make an observation concerning (22). (22) shows that the (relative) excitation levels  $\xi, \eta$  on the input bundles of its network generate approximately (i.e. for large  $\mathcal{N}$  and small  $\epsilon$ ) the (relative) excitation level  $\zeta_0 = 1 - \xi\eta$  on the output bundle of that network. This justifies the statements made in 9.4.1 about the detailed functioning of the network. Indeed: if the two input bundles are both prevalently stimulated, i.e. if  $\xi \sim 1, \eta \sim 1$  then the distance of  $\zeta_0$  from 0 is about the sum of the distances of  $\xi$  and of  $\eta$  from 1 :  $\zeta_0 = (1 - \xi) + \xi(1 - \eta)$ . If one of the two input bundles, say the first one, is prevalently non-stimulated, while the other one is prevalently stimulated, i.e. if  $\xi \sim 0, \eta \sim 1$ , then the distance of  $\zeta_0$  from 1 is about the distance of  $\xi$  from 0 :  $1 - \zeta_0 = \xi\eta$ . If both input bundles are prevalently non-stimulated, i.e. if  $\xi \sim 0, \eta \sim 0$ , then the distance of  $\zeta_0$  from 1 is small compared to the distances of both  $\xi$  and  $\eta$  from 0 :  $1 - \zeta_0 = \xi\eta$ .

## 10.5 Complete quantitative theory.

### 10.5.1 General results.

We can now pass to the complete statistical analysis of the Scheffer stroke operation on bundles. In order to do this, we must agree on a systematic way to handle this operation by a network. The system to be adopted will be the following: the necessary executive organ will be followed in series by a restoring organ. I.e. the Scheffer organ network of Figure 34 will be followed in series by the Scheffer organ network of Figure 37. This means that the formulas of (22) are to be followed by those of (24). Thus  $\xi, \eta$  are the excitation levels of the two input bundles,  $\psi$  is the excitation level of the output bundle, and we have:

$$(25) \quad \left\{ \begin{array}{l} \zeta = (1 - \xi\eta) + 2\epsilon(\zeta\eta - \frac{1}{2}) \\ \quad + \sqrt{\left((1 - 2\epsilon)^2\xi(1 - \xi)\eta(1 - \eta) + \epsilon(1 - \epsilon)\right)} / \mathcal{N} \delta^*, \\ \omega = (1 - \zeta^2) + 2\epsilon(\zeta^2 - \frac{1}{2}) \\ \quad + \sqrt{\left((1 - 2\epsilon)^2(\zeta(1 - \zeta))^2 + \epsilon(1 - \epsilon)\right)} / \mathcal{N} \delta^{**}, \\ \psi = (1 - \omega^2) + 2\epsilon(\omega^2 - \frac{1}{2}) \\ \quad + \sqrt{\left((1 - 2\epsilon)^2(\omega(1 - \omega))^2 + \epsilon(1 - \epsilon)\right)} / \mathcal{N} \delta^{***}, \\ \delta^*, \delta^{**}, \delta^{***} \text{ are stochastic variables, independently and normally} \\ \text{distributed, with the mean 0 and the dispersion 1.} \end{array} \right.$$

Consider now a given fiduciary level  $\Delta$ . Then we need a behavior, like the “correct” one of the Scheffer stroke, with an overwhelming probability. This means: the implication of  $\psi \leq \Delta$  by  $\xi \geq 1 - \Delta, \eta \geq 1 - \Delta$ ; the implication of  $\psi \geq 1 - \Delta$  by  $\xi \leq \Delta, \eta \geq 1 - \Delta$ ; the implication of  $\psi \geq 1 - \Delta$  by  $\xi \leq \Delta, \eta \leq \Delta$ . (We are, of course, using the symmetry in  $\xi, \eta$ .)

This may, of course, only be expected for  $\mathcal{N}$  sufficiently large and  $\epsilon$  sufficiently small. In addition, it will be necessary to make an appropriate choice of the fiduciary level  $\Delta$ .

If  $\mathcal{N}$  is so large and  $\epsilon$  is so small that all terms in (25) containing factors  $1/\sqrt{\mathcal{N}}$  and  $\epsilon$  can be neglected, then the above desired “overwhelmingly probable inferences” become even strictly true, if  $\Delta$  is small enough. Indeed, then (25) gives  $\zeta = \zeta_0 = 1 - \xi\eta$ ,  $\omega = \omega_0 = 1 - \zeta^2$ ,  $\psi = \psi_0 = 1 - \omega^2$ , i.e.  $\psi = 1 - (2\xi\eta - (\xi\eta)^2)^2$ . Now it is easy to verify  $\psi = O(\Delta^2)$  for  $\xi \geq 1 - \Delta, \eta \geq 1 - \Delta$ ;  $\psi = 1 - O(\Delta^2)$  for  $\xi \leq \Delta, \eta \geq 1 - \Delta$ ;  $\psi = 1 - O(\Delta^4)$  for  $\xi \leq \Delta, \eta \leq \Delta$ . Hence sufficiently small  $\Delta$  will guarantee the desiderata stated further above.

### 10.5.2 Numerical evaluation.

Consider next the case of a fixed, finite  $\mathcal{N}$  and a fixed, positive  $\epsilon$ . Then a more

elaborate calculation must be based on the complete formulæ of (25). This calculation will not be carried out here, but its results will be described.

The most favorable fiduciary level  $\Delta$ , from the point of view of this calculation turns out to be  $\Delta = .07$ . I.e. stimulation of at least 93% of the lines of a bundle represents a positive message; stimulation of at most 7% of the lines of a bundle represents a negative message; the interval between 7% and 93% is a zone of uncertainty, indicating an effective malfunction of the network.

Having established this fiduciary level, there exists also an upper bound for the allowable values of  $\epsilon$ . This is  $\epsilon = .0107$ . In other words if  $\epsilon \geq .0107$ , the risk of effective malfunction of the network will be above a fixed, positive lower bound, no matter how large a bundle size  $\mathcal{N}$  is used. The calculations were therefore continued with a specific  $\epsilon < .0107$ , namely, with  $\epsilon = .005$ .

With these assumptions, then, the calculation yields an estimate for the probability of malfunction of the network, i.e. of the violation of the desiderata stated further above. As is to be expected, this estimate is given by an error integral. This is

$$(26) \quad \begin{cases} \varrho(n) &= \frac{1}{\sqrt{2\pi}} \int_{\kappa}^{\infty} e^{-\frac{1}{2}x^2} dx \approx \frac{1}{\sqrt{2\pi\kappa}} e^{-\frac{1}{2}\kappa^2}, \\ \text{where} & \\ \kappa &= .062\sqrt{\mathcal{N}} \end{cases}$$

expresses, in a certain sense, the total allowable error divided by a composite standard deviation. The approximation is of course valid only for large  $\mathcal{N}$ . It can also be written in the form

$$(27) \quad \varrho(n) \approx \frac{6.4}{\sqrt{\mathcal{N}}} 10^{-\frac{8.6\mathcal{N}}{10,000}}.$$

The following table gives a better idea of the dependency expressed by the formula:\*

<u>n = number of lines in a bundle</u>	<u>p(n) = probability of malfunction</u>	Original value	Calculated from (26)
1,000		2.7 x 10-2	2.98 x 10-2
2,000		2.6 x 10-3	3.08 x 10-3
3,000		2.5 x 10-4	3.68 x 10-4
5,000		4.0 x 10-6	6.10 x 10-6
10,000		1.6 x 10-10	2.90 x 10-10
20,000		2.8 x 10-19	9.20 x 10-19
25,000		1.2 x 10-23	5.52 x 10-23

---

\* ed: equation (27) is in error. The original values are shown in column 2, the values calculated from equation (26) are shown in the last column. von Neumann must have used some other approximation which he meant to express in equation (27). In any case, he likely did the numerical calculations in his head in a minute or two, and they are sufficiently accurate for his purposes.

### 10.5.3 Examples.

#### 10.5.3.1 First example.

To get an idea of the significance of these sizes and the corresponding approximations, consider the two following examples.

Consider first a computing machine with 2500 vacuum tubes each of which is actuated on the average once every 5 microseconds. Assume that a mean free path of 8 hours between errors is desired. In this period of time there will have been  $\frac{1}{5} \times 2,500 \times 8 \times 3,600 \times 10^6 = 1.4 \times 10^{13}$  actuations, hence the above specification calls for  $\delta \sim 1/[1.4 \times 10^{13}] = 7 \times 10^{-14}$ . According to the above table this calls for an  $\mathcal{N}$  between 10,000 and 20,000 – interpolating linearly on  $-^{10} \log \delta$  gives  $\mathcal{N} = 14,000$ . I.e. the system should be multiplexed 14,000 times.

It is characteristic for the steepness of statistical curves in this domain of large numbers of events, that a 25 percent increase of  $\mathcal{N}$ , i.e.  $\mathcal{N} = 17,500$ , gives (again by interpolation)  $\delta = 4.5 \times 10^{-17}$ , i.e. a reliability which is 1,600 times better.

#### 10.5.3.2 Second example.

Consider second a plausible quantitative picture for the functioning of the human nervous system. The number of neurons involved is usually given as  $10^{10}$ , but this number may be somewhat low, also the synaptic end-bulbs and other possible autonomous sub-units may increase it significantly, perhaps a few hundred times. Let us therefore use the figure  $10^{13}$  for the number of basic organs that are present. A neuron may be actuated up to 200 times per second, but this is an abnormally high rate of actuation. The average neuron will probably be actuated a good deal less frequently, in the absence of better information 10 actuations per second may be taken as an average figure of at least the right order. It is hard to tell what the mean free path between errors should be. Let us take the view that errors properly defined are to be quite serious errors, and since they are not ordinarily observed, let us take a mean free path which is long compared to an ordinary human life – say 10,000 years. This means  $10^{13} \times 10,000 \times 31,536,000 \times 10 = 3.2 \times 10^{25}$  actuations, hence it calls for  $\delta \sim 1/(3.2 \times 10^{25}) = 3.2 \times 10^{-26}$ . According to the table this lies somewhat beyond  $\mathcal{N} = 25,000$  – extrapolating linearly on  $-^{10} \log \delta$  gives  $\mathcal{N} = 28,000$ .

Note, that if this interpretation of the functioning of the human nervous system were a valid one (for this cf. the remark of 11.1), the number of basic organs involved would have to be reduced by a factor 28,000. This reduces the number of relevant actuations and increases the value of the necessary  $\delta$  by the same factor. I.e.  $\delta = 9 \times 10^{-22}$ , and hence  $\mathcal{N} = 23,000$ . The reduction of  $\mathcal{N}$  is remarkably small – only 20%. This makes a reevaluation of the reduced  $\mathcal{N}$  with the new  $\mathcal{N}$ ,  $\delta$  unnecessary: in fact the new factor, i.e. 23,000, gives  $\delta = 7.4 \times 10^{-22}$  and this with the approximation used above, again  $\mathcal{N} = 23,000$ . (Actually the change of  $\mathcal{N}$  is  $\sim 120$ , i.e. only 1/2%!)

Replacing the 10,000 years, used above rather arbitrarily, by 6 months, introduces another factor 20,000, and therefore a change of about the same size as the above

one – now the value is easily seen to be  $\mathcal{N} = 23,000$  (uncorrected) or  $\mathcal{N} = 19,000$  (corrected).

## 10.6 Conclusions.

All this shows that the order of magnitude of  $\mathcal{N}$  is remarkably insensitive to variations in the requirements, as long as these requirements are rather exacting ones, but not wholly outside the range of our (industrial or natural) experience. Indeed, the  $\mathcal{N}$  obtained above were all  $\sim 20,000$ , to within variations lying between -30% and +40%.

## 10.7 The general scheme of multiplexing.

This is an opportune place to summarize our results concerning multiplexing, i.e. the Sections 9 and 10. Suppose it is desired to build a machine to perform the logical function  $f(x, y, \dots)$  with a given accuracy (probability of malfunction on the final result of the entire operation)  $\eta$ , using Scheffer neurons whose reliability (or accuracy), i.e. probability of malfunction on a single operation) is  $\epsilon$ . We assume  $\epsilon = .005$ . The procedure is then as follows.

First, design a network  $\mathcal{R}$  for this function  $f(x, y, \dots)$  as though the basic (Scheffer) organs had perfect accuracy. Second, estimate the maximum number of single (perfect) Scheffer organ reactions (summed over all successive operations of all the Scheffer organs actually involved) that occur in the network  $\mathcal{R}$  in evaluating  $f(x, y, \dots)$  – say  $m$  such reactions. Put  $\delta = \eta/m$ . Third, estimate the bundle size  $\mathcal{N}$  that is needed to give the multiplexed Scheffer organ-like network (cf. 10.5.2) an error probability of at most  $\delta$ . Fourth, replace each single line of the network  $\mathcal{R}$  by a bundle of size  $\mathcal{N}$ , and each Scheffer neuron of the network  $\mathcal{R}$  by the multiplexed Scheffer organ network that goes with this  $\mathcal{N}$  (cf. 10.5.1. (p. 43)) – this gives a network  $\mathcal{Q}^{(\mathcal{N})}$ . A “yes” will then be transmitted by the stimulation of more than 93% of the strands in a bundle, a “no” by the stimulation of less than 7%, and intermediate values will signify the occurrence of an essential malfunction of the total system.

It should be noticed that this construction multiplies the number of lines by  $\mathcal{N}$  and the number of basic organs by  $3\mathcal{N}$ . (In 10.5.3 we used a uniform factor of multiplication  $\mathcal{N}$ . In view of the insensitivity of  $\mathcal{N}$  to moderate changes in  $\delta$  that we observed in 10.5.3.2, this difference is irrelevant.) Our above considerations show that the size of  $\mathcal{N}$  is  $\sim 20,000$  in all cases that interest us immediately. This implies that such techniques are impractical for present technologies of componentry (although this may perhaps not be true for certain conceivable technologies of the future), but they are not necessarily unreasonable (at least not on grounds of size alone) for the micro-componentry of the human nervous system.

Note that the conditions are significantly less favorable for the non-multiplexing procedure to control error described in Section 8 (p. 23). That process multiplied the number of basic organs by  $3^\mu$ ,  $\mu$  being the number of consecutive steps (i.e.

basic organ actuations) from input to output, (cf. the end of 8.4). (In this way of counting, iterative processes must be counted as many times as iterations occur.) Thus for  $\mu = 160$ , which is not an excessive “logical depth,” even for a conventional calculation,  $3^{160} \sim 2 \times 10^{76}$ , i.e. somewhat above the putative order of the number of electrons in the universe. For  $\mu = 200$  (only 25% more!) then  $3^{200} \sim 2.5 \times 10^{95}$ , i.e.  $1.2 \times 10^{19}$  times more – in view of the above this requires no comment.

## 11. GENERAL COMMENTS ON DIGITALIZATION AND MULTIPLEXING.

### 11.1 Plausibility of various assumptions regarding the digital vs. analog character of the nervous system.

Now we pass to some remarks of a more general character.

The question of the number of basic neurons required to build a multiplexed automaton serves as an introduction for the first remark. The above discussion shows that the multiplexing technique is impractical on the level of present technology, but quite practical for a perfectly conceivable more advanced technology and for the natural relay organs (neurons). I.e. it merely calls for a, not at all unnatural, micro-componentry. It is therefore quite reasonable to ask specifically, whether it, or some thing more or less like it, is a feature of the actually existing human (or rather animal) nervous system.

The answer is not clear cut. The main trouble with the multiplexing systems, as described in the preceding Section, is that they follow too slavishly a fixed plan of construction – and specifically one, that is inspired by the conventional procedures of mathematics and mathematical logics. It is true that the animal nervous systems, too, obey some rigid “architectural” patterns in their large-scale construction, and that those varieties, which make one suspect a merely statistical design seem to occur only in finer detail and on the micro-level. (It is characteristic of this duality that most investigators believe in the existence of overall laws of large-scale nerve-stimulation and composite action that have only a statistical character, and yet occasionally a single neuron is known to control a whole reflex-arc.) It is true, that our multiplexing scheme, too, is rigid only in its large-scale pattern (the prototype network  $\mathcal{R}$ , as a pattern, and the general layout of the executive-plus-restoring organ, as discussed in 10.7 and in 10.5.1), while the “random” permutation “black boxes” (cf. the relevant Figures 32, 35, 37 in 9.2.3 and 9.4.2) are typical of a “merely statistical design.” Yet the nervous system seems to be somewhat more flexibly designed. Also, its “digital” (neural) operations are rather freely alternating with “analog” (humoral) processes in their complete chains of causation. Finally the whole logical pattern of the nervous system seems to deviate in certain important traits qualitatively and significantly from our ordinary mathematical and mathematical-logical modes of operation. The pulse-trains that carry “quantitative” messages along the nerve fibers do not seem

to be coded digital expressions (like a binary or a (Morse or binary coded) decimal digitalization) of a number, but rather “analog” expressions of one, by way of their pulse-density, or something similar – although much more than ordinary care should be exercised in passing judgments in this field, where we have so little factual information. Also, the “logical depth” of our neural operations – i.e. the total number of basic operations from (sensual) input to (memory) storage or (motor) output seems to be much less than it would be in any human automaton (e.g. a computing machine) dealing with problems of anywhere nearly comparable complexity. Thus deep differences in the basic organizational principles are probably present.

Some similarities, in addition to the one referred to above, are nevertheless undeniable. The nerves are bundles of fibers – like our bundles. The nervous system contains numerous “neural pools” whose function may well be that of organs devoted to the restoring of excitation levels. (At least of the two (extreme) levels, e.g. one near to 0 and one near to 1, as in the case discussed in Section 9, especially in 9.2.2, and 9.2.3, 9.4.2. Restoring one level only – by exciting or quenching or establishing some intermediate stationary level – destroys rather than restores information, since a system with a single stable state has a memory capacity 0 (cf. the definition given in 5.2. (p. 15)). For systems which can stabilize (i.e. restore) more than two excitation levels, cf. 12.6. (p. 55))

## 11.2 Remarks concerning the concept of a random permutation.

The second remark on the subject of multiplexed systems concerns the problem (which was so carefully sidestepped in Section 9) of maintaining randomness of stimulation. For all statistical analyses, it is necessary to assume that this randomness exists. In networks which allow feedback, however, when a pulse from an organ gets back to the same organ at some later time, there is danger of strong statistical correlation. Moreover without randomness, situations may arise where errors tend to be amplified instead of canceled out. E.g. it is possible, that the machine remembers its mistakes, so to speak, and thereafter perpetuates them. A simplified example of this effect is furnished by the elementary memory organ of Figure 16 (p. 14), or by a similar one, based on the Scheffer stroke, shown in Figure 39. We will discuss the latter. This system, provided it makes no mistakes, fires on alternate moments of time. Thus it has two possible states: Either it fires at even times or at odd times. (For a quantitative discussion of Figure 16, cf. 5.1. (p. 14)) However, once the mechanism makes a mistake, i.e. if it fails to fire at the right parity, or if it fires at the wrong parity, that error will be remembered, i.e. the parity is now lastingly altered, until there occurs a new mistake. A single mistake thus destroys the memory of this particular machine for all earlier events. In multiplex systems, single errors are not necessarily disastrous: but without the “random” permutations introduced in Section 9, accumulated mistakes can be still dangerous.



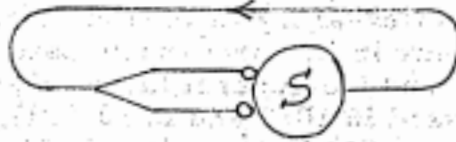

Fig. 39

To be more specific: consider the network shown in Figure 35 (p. 36), but without the line-permuting “black box”  $\mathcal{U}$ . If each output line is now fed back into its input line (i.e. into the one with the same number from above), then pulses return to the identical organ from which they started, and so the whole organ is in fact a sum of separate organs according to Figure 39, and hence it is just as subject to error as a single one of those organs acting independently. However, if a permutation of the bundle is interposed as shown, in principle, by  $\mathcal{U}$  in Figure 35, then the accuracy of the system may be (statistically) improved. This is, of course, the trait which is being looked for by the insertion of  $\mathcal{U}$ , i.e. of a “random” permutation in the sense of Section 9. But how is it possible to perform a “random” permutation?

The problem is not immediately rigorously defined. It is, however, quite proper to reinterpret it as a problem that can be stated in a rigorous form, namely: it is desired to find one or more permutations which can be used in the “blackboxes” marked with  $\mathcal{U}$  or  $\mathcal{U}_1, \mathcal{U}_2$  in the relevant Figures 35, 37, so that the essential statistical properties that are asserted there are truly present. Let’s consider the simpler one of these two, i.e. the multiplexed version of the simple memory organ of Figure 39 – i.e. a specific embodiment of Figure 35. The discussion given in 10.3 (p. 41) shows that it is desirable that the permutation  $\mathcal{U}$  of Figure 35 permute the even lines among each other, and the odd lines among each other. A possible rigorous variant of the question that should now be asked is this.

Find a fiduciary level  $\Delta > 0$  and a probability  $\epsilon > 0$ , such that for any  $\eta > 0$  and any  $s = 1, 2, \dots$  there exists an  $\mathcal{N} = \mathcal{N}(\eta, s)$  and a permutation  $\mathcal{U} = \mathcal{U}^{(\mathcal{N})}$ , satisfying the following requirement: assume that the probability of error in a single operation of any given Scheffer organ is  $\epsilon$ . Assume that at the time  $t$  all lines of the above network are stimulated, or that all are not stimulated. Then the number of lines stimulated at the time  $t + s$  will be  $\geq (1 - \Delta)\mathcal{N}$  or  $\leq \Delta\mathcal{N}$ , respectively, with a probability  $\geq 1 - \delta$ . In addition  $\mathcal{N}(\eta, s) \leq C \ln(s/\eta)$  with a constant  $C$  (which should not be excessively great).

Note, that the results of Section 10 make the surmise seem plausible, that  $\Delta = .07, \epsilon = .005$  and  $C \sim 10,000/[8.6 \times \ln 10] \sim 500$  are suitable choices for the above purpose.

The following surmise concerning the nature of the permutation  $\mathcal{U}^{(\mathcal{N})}$  has a certain plausibility: let  $\mathcal{N} = 2^l$ . Consider the  $2^l$  complexes  $(d_1, d_2, \dots, d_l)$  ( $d_\lambda = 0, 1$ , for  $\lambda = 1, \dots, l$ ). Let these correspond in some one to one way to the  $2^l$  integers  $i = 1, \dots, \mathcal{N}$ :

$$(28) \quad i \Leftrightarrow (d_1, d_2, \dots, d_l)$$

Now let the mapping

$$(29) \quad i \rightarrow i' = \mathcal{U}^{(\mathcal{N})}i$$

be induced, under the correspondence (28), by the mapping

$$(30) \quad (d_1, d_2, \dots, d_l) \rightarrow (d_l, d_1, \dots, d_{l-1}).$$

Obviously, the validity of our assertion is independent of the choice of the correspondence (28). Now (30) does not change the parity of  $\sum_{\lambda=1}^l d_\lambda$ , hence the desideratum that  $\mathcal{U}^{(\mathcal{N})}$  i.e. (29), should not change the parity of  $i$  (cf. above) is certainly fulfilled, if the correspondence (28) is so chosen as to let  $i$  have the same parity as  $\sum_{\lambda=1}^l d_\lambda$ . This is clearly possible, since on either side each parity occurs precisely  $2^{l-1}$  times. This  $\mathcal{U}^{(\mathcal{N})}$  should fulfill the above requirements.

### 11.3 Remarks concerning the simplified probability assumption.

The third remark on multiplexed automata concerns the assumption made in defining the unreliability of an individual neuron. It was assumed that the probability of the neuron failing to react correctly was a constant  $\epsilon$ , independent of time and of all previous inputs. This is an unrealistic assumption. For example, the probability of failure for the Scheffer organ of Figure 12 (p. 11) may well be different when the inputs  $\alpha$  and  $\beta$  are both stimulated, from the probability of failure when  $\alpha$  and not  $\beta$  is stimulated. In addition, these probabilities may change with previous history, or simply with time and other environmental conditions. Also, they are quite likely to be different from neuron to neuron. Attacking the problem with these more realistic assumptions means finding the domains of operability of individual neurons, finding the intersection of these domains (even when drift with time is allowed) and finally carrying out the statistical estimates for this far more complicated situation. This will not be attempted here.

## 12. ANALOG POSSIBILITIES.

### 12.1 Further remarks concerning analog procedures.

There is no valid reason for thinking that the system which has been developed in the past pages is the only or the best model of any existing nervous system or of any potential error-safe computing machine or logical machine. Indeed, the form of our model-system is due largely to the influence of the techniques developed for digital computing and to the trends of the last sixty years in mathematical logics. Now, speaking specifically of the human nervous system this is an enormous mechanism – at least  $10^6$  times larger than any artifact with which we are familiar – and its activities are correspondingly varied and complex. Its duties include the interpretation of external sensory stimuli, of reports of physical and chemical conditions, the control

of motor activities and of internal chemical levels, the memory function with its very complicated procedures for the transformation of and the search for information, and of course, the continuous relaying of coded orders and of more or less quantitative messages. It is possible to handle all these processes by digital methods (i.e. by using numbers and expressing them in the binary system – or, with some additional coding tricks, in the decimal or some other system), and to process the digitalized, and usually numericized, information by algebraical (i.e. basically arithmetical) methods. This is probably the way how a human designer would at present approach such a problem. It was pointed out in the discussion in 11.1. (p.47), that the available evidence, though scanty and inadequate, rather tends to indicate that the human nervous system uses different principles and procedures. Thus message pulse trains seem to convey meaning by certain analogic traits (within the pulse notation – i.e. this seems to be a mixed, part digital, part analog system), like the time density of pulses in one line, correlations of the pulse time series between different lines in a bundle, etc.

Hence our multiplexed system might come to resemble the basic traits of the human nervous system more closely if we attenuated its rigidly discrete and digital character in some respects. The simplest step in this direction, which is rather directly suggested by the above remarks about the human nervous system, would seem to be this.

## 12.2 A possible analog procedure.

### 12.2.1 The set up.

In our prototype network  $\mathcal{R}$  each line carries a “yes” (i.e. stimulation) or a “no” (i.e. non-stimulation) message – these are interpreted as digits 1 and 0, respectively. Correspondingly, in the final (multiplexed) network  $\mathcal{R}^{(\mathcal{N})}$  (which is derived from  $\mathcal{R}$ ) each bundle carries a “yes” = 1 (i.e. prevalent stimulation) or a “no” = 0 (i.e. prevalent non-stimulation) message. Thus only two meaningful states, i.e. average levels of excitation are allowed for a bundle – actually for one of these  $\xi \sim 1$  and for the other  $\xi \sim 0$ .

Now for large bundle sizes  $\mathcal{N}$  the average excitation level,  $\xi$ , is an approximately continuous quantity (in the interval  $0 \leq \xi \leq 1$ ) – the larger  $\mathcal{N}$ , the better the approximation. It is therefore not unreasonable to try to evolve a system in which  $\xi$  is treated as a continuous quantity in  $0 \leq \xi \leq 1$ . This means an analog procedure (or rather, in the sense discussed above, a mixed, part digital, part analog procedure). The possibility of developing such a system depends, of course, on finding suitable algebraic procedures that fit into it, and being able to assure its stability in the mathematical sense (i.e. adequate precision) and in the logical sense (i.e. adequate control of errors). To this subject we will now devote a few remarks.

### 12.2.2 The operations.

Consider a multiplex automaton of the type which has just been considered in 12.2.1, with bundle size  $\mathcal{N}$ . Let  $\xi$  denote the level of excitation of the bundle at any point, that is, the relative number of excited lines. With this interpretation, the automaton is a mechanism which performs certain numerical operations on a set of numbers to give a new number (or numbers). This method of interpreting a computer has some advantages, as well as some disadvantages in comparison with the digital, "all or nothing," interpretation. The conspicuous advantage is that such an interpretation allows the machine to carry more information with fewer components than a corresponding digital automaton. A second advantage is that it is very easy to construct an automaton which will perform the elementary operations of arithmetics. (Or, to be more precise: an adequate subset of these. Cf. the discussion in 12.3) For example, given  $\xi$  and  $\eta$  it is possible to obtain  $\frac{1}{2}(\xi + \eta)$  as shown in Figure 40. Similarly, it is possible to obtain  $\alpha\xi + (1 - \alpha)\eta$  for any constant  $\alpha$  with  $0 \leq \alpha \leq 1$ . (Of course, there must be  $\alpha = M/N, M = 0, 1, \dots, N$ , but this range for  $\alpha$  is the same "approximate continuum" as that one for  $\xi$ , hence we may treat the former as a continuum just as properly as the latter.) We need only choose  $\alpha\mathcal{N}$  lines from the first bundle and combine them with  $(1 - \alpha)\mathcal{N}$  lines from the second. To obtain the quantity  $1 - \xi\eta$  requires the following set-up shown in Figure 41. Finally we can produce any constant excitation level  $\alpha$  ( $0 \leq \alpha \leq 1$ ), by originating a bundle so that  $\alpha\mathcal{N}$  lines come from a live source and  $(1 - \alpha)\mathcal{N}$  from ground.

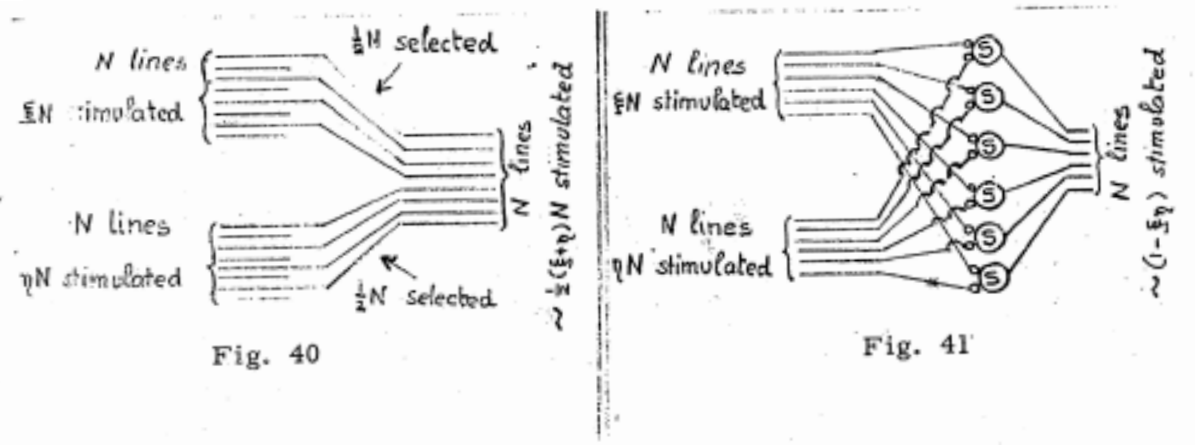

### 12.3 Discussion of the algebraical calculus resulting from the above operations.

Thus our present analog system can be used to build up a system of algebra where the fundamental operations are

$$(31) \quad \left\{ \begin{array}{l} \alpha \\ \alpha\xi + (1 - \alpha)\eta \\ 1 - \xi\eta \end{array} \right\} \quad \left\{ \begin{array}{l} \text{(for any constant } \alpha \text{ in)} \\ 0 \leq \alpha \leq 1, \end{array} \right\}$$

All these are to be viewed as functions of  $\xi, \eta$ . They lead to a system, in which one can operate freely with all those functions  $f(\xi_1, \xi_2, \dots, \xi_k)$  of any  $k$  variables  $\xi_1, \xi_2, \dots, \xi_k$ , that the functions of (31) generate. I.e. with all functions that can be obtained by any succession of the following processes:

- (A) In the functions of (31) replace  $\xi, \eta$  by any variables  $\xi_i, \xi_j$ .
- (B) In a function  $f(\xi_1^*, \dots, \xi_l^*)$ , that has already been obtained, replace the variables  $f(\xi_1^*, \dots, \xi_l^*)$ , by any functions  $g_1(\xi_1, \dots, \xi_k), \dots, g_l(\xi_1, \dots, \xi_l)$ , respectively, that have already been obtained.

To these, purely algebraical-combinatorial processes we add a properly analytical one, which seems justified, since we have been dealing with approximative procedures, anyway:

- (C) If a sequence of functions  $f_\mu(\xi_1, \dots, \xi_k), \mu = 1, 2, \dots$ , that have already been obtained, converges uniformly (in the domain  $0 \leq \xi_1 \leq 1, \dots, 0 \leq \xi_k \leq 1$ ) for  $\mu \rightarrow \infty$  to  $f(\xi_1, \dots, \xi_k)$ , then form this  $f(\xi_1, \dots, \xi_k)$ .

Note, that in order to have the freedom of operation as expressed by (A), (B), the same “randomness” conditions must be postulated as in the corresponding parts of Sections 9 and 10. Hence “randomizing” permutations  $\mathcal{U}$  must be interposed between consecutive executive organs (i.e. those described above and reenumerated in (A)), just as in the Sections referred to above.

In ordinary algebra the basic functions are different ones, namely:

$$(32) \quad \left\{ \begin{array}{c} \alpha \\ \xi + \eta \\ \xi\eta \end{array} \right\} \quad \left\{ \begin{array}{l} \text{(for any constant } \alpha \text{ in} \\ 0 \leq \alpha \leq 1), \end{array} \right\}$$

It is easily seen that the system (31) can be generated (by (A), (B)) from the system (32), while the reverse is not obvious (not even with (C) added). In fact (31) is intrinsically more special than (32), i.e. the functions that (31) generates are fewer than those that (32) generates (this is true for (A), (B), and also for (A), (B), (C)) – the former do not even include  $\xi + \eta$ . Indeed all functions of (31), i.e. of (A) based on (31), have this property: If all variables lie in the interval  $0 \leq \xi \leq 1$ , then the function, too, lies in that interval. This property is conserved under the applications of (B), (C). On the other hand  $\xi + \eta$  does not possess this property – hence it cannot be generated by (A), (B), (C) from (31). (Note that the above property of the functions of (31), and of all those that they generate, is a quite natural one: They are all dealing with excitation levels, and excitation levels must, by their nature, be numbers  $\xi$  with  $0 \leq \xi \leq 1$ .)

In spite of this limitation, which seems to mark it as essentially narrower than conventional algebra, the system of functions generated (by (A), (B), (C)) from (31) is broad enough for all reasonable purposes. Indeed, it can be shown that the functions so generated comprise precisely the following class of functions:

All functions  $f(\xi_1, \xi_2, \dots, \xi_k)$  which, as long as their variables  $\xi_1, \xi_2, \dots, \xi_k$  lie in the interval  $0 \leq \xi \leq 1$ , are continuous and have their value lying in that interval, too.

We will not give the proof here, it runs along quite conventional lines.

## 12.4 Limitations of this system.

This result makes it clear that the above analog system, i.e. the system of (31), guarantees for numbers  $\xi$  with  $0 \leq \xi \leq 1$ , (i.e. for the numbers that it deals with, namely excitation levels) the full freedom of algebra and of analysis.

In view of these facts, this analog system would seem to have clear superiority over the digital one. Unfortunately, the difficulty of maintaining accuracy levels counterbalances the advantages to a large extent. The accuracy can never be expected to exceed  $1/\mathcal{N}$ . In other words, there is an intrinsic noise level of the order  $1/\mathcal{N}$ , i.e. for the  $\mathcal{N}$  considered in 10.5.2 and 10.5.3 (up to  $\sim 20,000$ ) at best  $10^{-4}$ . Moreover, in its effects on the operations of (31), this noise level rises from  $1/\mathcal{N}$  to  $1/\sqrt{\mathcal{N}}$ . (E.g. for the operation  $1 - \xi\eta$ , cf. the result (21) and the argument that leads to it.) With the above assumptions, this is at best,  $\sim 10^{-2}$ , i.e. 1%! Hence after a moderate number of operations the excitation levels are more likely to resemble a random sampling of numbers than mathematics.

It should be emphasized, however, that this is not a conclusive argument that the human nervous system does not utilize the analog system. As was pointed out earlier, it is in fact known for at least some nervous processes that they are of an analog nature, and that the explanation of this may, at least in part, lie in the fact that the “logical depth” of the nervous network is quite shallow in some relevant places. To be more specific: the number of synapses of neurons from the peripheral sensory organs down the afferent nerve fibers, through the brain, back through the efferent nerves to the motor system may not be more than  $\sim 10$ . Of course the parallel complexity of the network of neurons is indisputable. “Depth” introduced by feedback in the human brain may be overcome by some kind of self-stabilization. At the same time, a good argument can be put up that the animal nervous system uses analog methods (as they are interpreted above) only in the crudest way, accuracy being a very minor consideration.

## 12.5 A plausible analog mechanism: Density modulation by fatigue.

Two more remarks should be made at this point. The first one deals with some more specific aspects of the analog element in the organization and functioning of the human nervous system. The second relates to the possibility of stabilizing the precision level of the analog procedure that was outlined above.

This is the first remark. As we have mentioned earlier, many neurons of the nervous system transmit intensities (i.e. quantitative data) by analog methods, but, in a way entirely different from the method described in 12.2, 12.3 and 12.4 (p. 51-54). Instead of the level of excitation of a nerve (i.e. of a bundle of nerve fibers) varying, as described in 12.2, the single nerve fibers fire repetitiously, but with varying frequency in time. For example, the nerves transmitting a pressure stimulus may vary in frequency between, say, 6 firings per second and, say, 60 firings per second. This

frequency is a monotone function of the pressure. Another example is the optic nerve, where a certain set of fibers responds in a similar manner to the intensity of the incoming light. This kind of behavior is explained by the mechanism of neuron operation, and in particular with the phenomena of threshold and of fatigue. With any peripheral neuron at any time can be associated a threshold intensity: A stimulus will make the neuron fire if and only if its magnitude exceeds the threshold intensity. The behavior of the threshold intensity as a function of the time after a typical neuron fires is qualitatively pictured in Figure 42. After firing, there is an "absolute refractory period" of about 5 milliseconds, during which no stimulus can make the neuron fire again. During this period, the threshold value is infinite. Next comes a "relative refractory period" of about 10 milliseconds, during which time the threshold level drops back to its equilibrium value (it may even oscillate about this value a few times at the end). This decrease is for the most part monotonic. Now the nerve will fire again as soon as it is stimulated with an intensity greater than its excitation threshold. Thus if the neuron is subjected to continual excitation of constant intensity (above the equilibrium intensity), it will fire periodically with a period between 5 and 15 milliseconds, depending on the intensity of the stimulus.

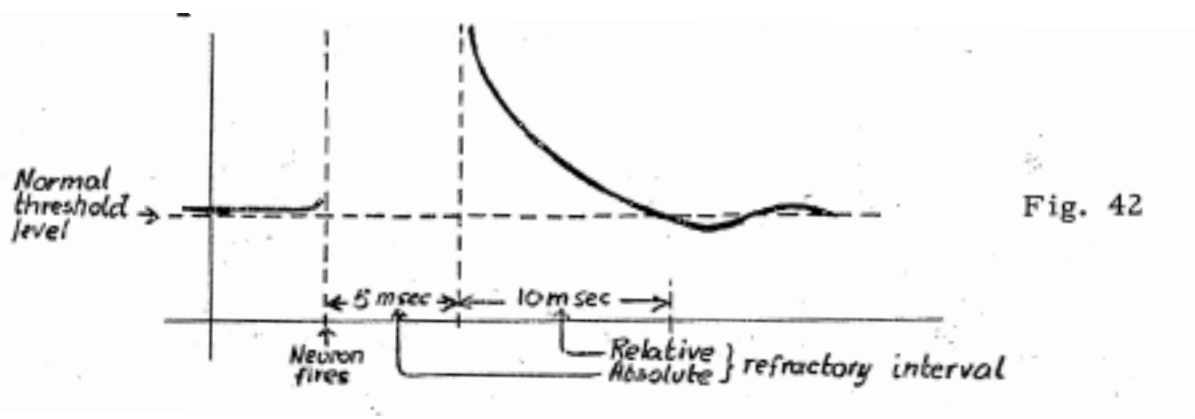

Another interesting example of a nerve network which transmits intensity by this means is the human acoustic system. The ear analyzes a sound wave into its component frequencies. These are transmitted to the brain through different nerve fibers with the intensity variations of the corresponding component represented by the frequency modulation of nerve firing.

The chief purpose of all this discussion of nervous systems is to point up the fact that it is dangerous to identify the real physical (or biological) world with the models which are constructed to explain it. The problem of understanding the animal nervous action is far deeper than the problem of understanding the mechanism of a computing machine. Even plausible explanations of nervous reaction should be taken with a very large grain of salt.

## 12.6 Stabilization of the analog system.

We now come to the second remark. It was pointed out earlier, that the analog mechanism that we discussed may have a way of stabilizing excitation levels to a certain precision for its computing operations. This can be done in the following way.

For the digital computer, the problem was to stabilize the excitation level at (or near) the two values 0 and 1. This was accomplished by repeatedly passing the bundle through a simple mechanism which changed an excitation level  $\xi$  into the level  $f(\xi)$  where the function  $f(\xi)$  had the general form shown in Figure 43. The reason that such a mechanism is a restoring organ for the excitation levels  $\xi \sim 0$  and  $\xi \sim 1$  (i.e. that it stabilizes at - or near - 0 and 1) is that  $f(\xi)$  has this property: For some suitable  $\beta$  ( $0 \leq \beta \leq 1$ )  $0 < \xi < \beta$  implies  $0 < f(\xi) < \xi$ ;  $\beta < \xi < 1$  implies  $\xi < f(\xi) < 1$ . Thus  $\xi = 0, 1$  are the only stable fixpoints of  $f(\xi)$ . (Cf. the discussion in 9.2.3 and 9.4.2.)

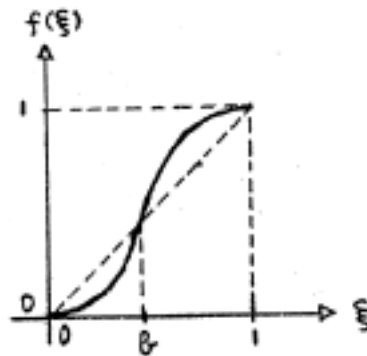

Fig. 43

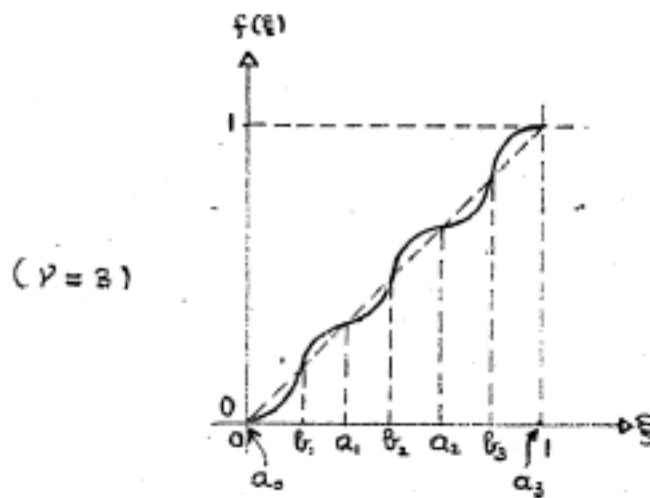

Fig. 44.



Now consider another  $f(\xi)$  which has the form shown in Figure 44.  
I.e. we have:

$$0 = \alpha_0 < \beta_1 < \alpha_1 < \dots < \alpha_{\nu-1} < \beta_\nu < \alpha_\nu = 1,$$

for  $i = 1, \dots, \nu$ :  $\alpha_{i-1} < \xi < \beta_i$  implies  $\alpha_{i-1} < f(\xi) < \xi$ ,  
 $\beta_i < \xi < \alpha_i$  implies  $\xi < f(\xi) < \alpha_i$ .

Here  $\alpha_0(= 0), \alpha_1, \dots, \alpha_{\nu-1}, \alpha_\nu(= 1)$  are  $f(\xi)$ 's only stable fixpoints, and such a mechanism is a restoring organ for the excitation levels  $\xi \sim \alpha_0(= 0), \alpha_1, \dots, \alpha_{\nu-1}, \alpha_\nu(= 1)$ . Choose, e.g.  $\alpha_i = i/\nu$  ( $i = 0, 1, \dots, \nu$ ), with  $\nu^{-1} < \beta$ , or more generally, just  $\alpha_i - \alpha_{i-1} < \delta$  ( $i = 1, \dots, \nu$ ) with some suitable  $\nu$ . Then this restoring organ clearly conserves precisions of the order  $\delta$  (with the same prevalent probability with which it restores).

## 13. CONCLUDING REMARK.

### 13.1 A possible neurological interpretation.

There remains the question, whether such a mechanism is possible with the means that we are now envisaging. We have seen further above that this is the case, if a function  $f(\xi)$  with the properties just described can be generated from (31). Such a function can indeed be so generated. Indeed, this follows immediately from the general characterization of the class of functions that can be generated from (31), discussed in 12.3 (p. 52). However, we will not go here into this matter any further.

It is not inconceivable that some “neural pools” in the human nervous system may be such restoring organs, to maintain accuracy in those parts of the network where the analog principle is used, and where there is enough “logical depth” (cf. 12.4 (p. 54)) to make this type of stabilization necessary.

---

## References

- [1] S. C. Kleene, "Representation of Events in Nerve Nets and Finite Automata," RAND Research Memorandum RM 704 (The RAND Corp., 1500 Fourth St., Santa Monica, Calif.) Dec. 1951.
- [2] W. S. McCulloch and W. Pitts, "A logical calculus of the ideas imminent in nervous activity," Bull. of Math. Biophysics, 5 (1943), p. 115-133.
- [3] C. E. Shannon, "A Mathematical theory of communication," The Bell System Tech. Jour., 27(1948), p. 379-423.
- [4] L. Szilard, "Über die Entropieverminderung in einem thermodynamischen System bei Eingriffen intelligenter Wesen," Zeitschrift für Physik, 53(1929), p. 840-856.
- [5] A. M. Turing "On computable numbers," Proc. of the London Math. Soc. 2-42(1937), p. 230-265.