

# Paper Airplanes

## Materials

1. Different types of paper (printer paper, construction paper, oaktag, tissue paper, newspaper, etc.)
2. Scissors

## Directions

1. Choose a type of paper airplane to make. Suggestions are attached to this worksheet. You can also try to make your own!
2. Fly your paper airplanes.
3. Compare the flights of different types of airplanes and different types of papers.

## Questions

1. Why do some airplanes fly better than others?
2. How do the different papers effect the flight? Are different papers easier to work with?
3. Why do some papers work better than others?
4. Based on how well your planes flew, can you explain how planes fly?

# The Deltry Paper Airplane

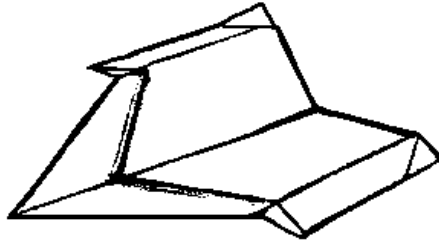

**The Deltry paper airplane is easy to fly, and very easy to make. It flies slowly, and very smoothly and gently. And it holds together nicely. It's a good bet to become the standard paper airplane people make, because it's easy and the results are amazingly good.**

**Because this is the simplest plane here, and the first, pardon us for explaining how to create it quite slowly and carefully, so that everyone can follow along, in twelve very simple steps.**

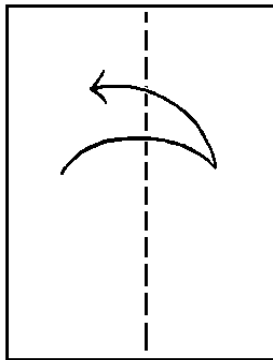

**1. Take an 8 1/2 by 11 inch sheet of paper, and crease it along the middle, by folding it in half lengthwise along the dashed "valley fold" line shown and unfold again.**

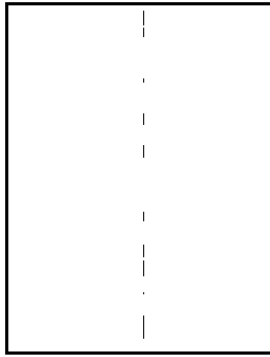

**2. After this point, the result of one folding operation will be shown together with the next folding instructions.**

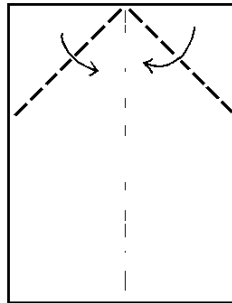

**3. Now fold down the top corners inward to the center crease along the dashed "valley folds" shown, making two new right-angle triangles visible in illustration 4.**

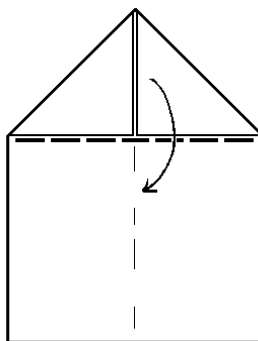

4. Fold the large top triangle (made up of the two small triangles you just created in step 3), over and down.

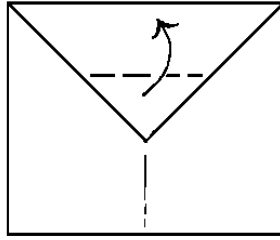

5. Fold the lower part of the tip of the large triangle up again.  
But note - not quite all the way up to the top.

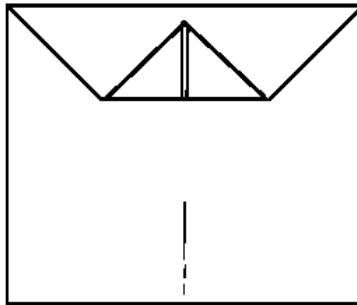

6. Leave about 3/8ths of an inch of space from the top. This will help the flaps to lock under tightly and keep the airplane together when it's done.

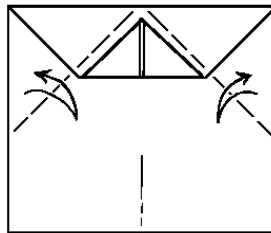

- 7. Fold and unfold two top triangles, much as you did in step 3, where the dashed valley folds are shown. Just as in step 3, the inner edges of the new triangles should line up with the center line of the plane you are making. That is to say, don't try to fold right up against the tip you folded up in step 5, since that tip is supposed to be a bit lower.**

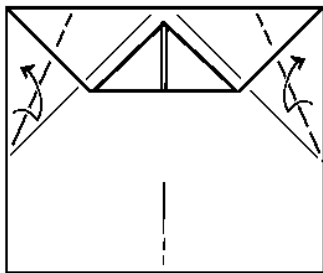

**8. Now bisect the new folds you made, using the previous creases you just made in step 7 as a guide. Fold and then unfold along the two dashed lines, leaving you back where you started, having created two new upper creases.**

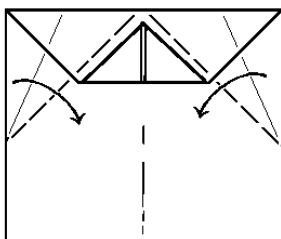

9. Now you can fold the two large right angle triangles down again, repeating the first part of step 7. For the moment, ignore the two new creases you just created in step 8.

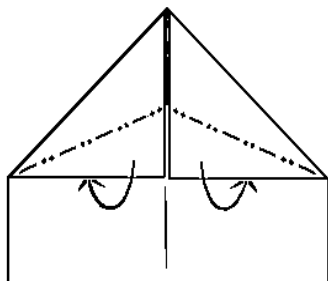

10. Fold along the two dotted-and-dashed "mountain folds", tucking the lower triangles well underneath, snugly locking them in place. (These two triangles of paper go under the tip you folded up in step 5.) The next diagram, Diagram 11, actually shows this being done. You've almost made a paper airplane.

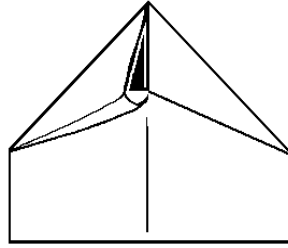

11. The tucking operation shown in progress. Tuck it way under so that everything holds together.

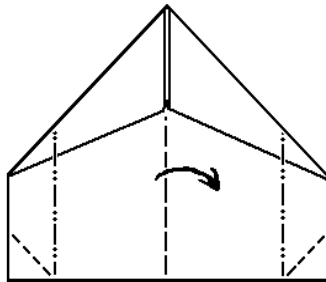

12. Now you have to make a few partial folds and the airplane is complete. Be sure to distinguish the dashed "valley folds" (that create a valley) from the dashed-and-dotted "mountain folds" that create slight hills. Take a peek ahead at illustrations 13 and 14 on the next page to see the paper airplane you are trying to create, if you like.

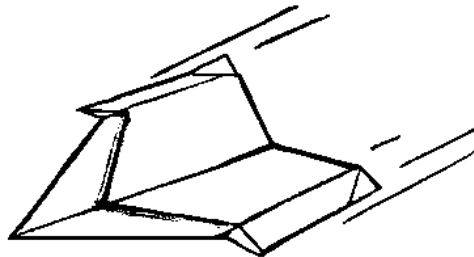

**13. The Deltry aircraft in flight - remember that it's a very slow flyer, much slower (and more graceful) than most paper airplanes. Don't throw it, just release it while your hand is moving forward slowly. One good grip is shown below in diagram 15.**

# The Tumble

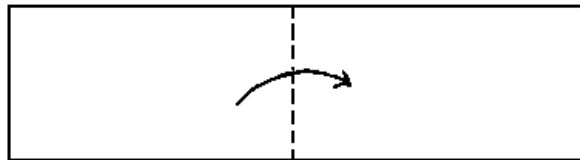
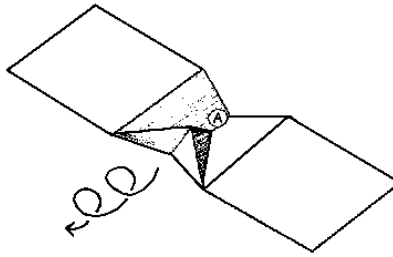

**1. Take a sheet of thin paper, about 1 inch by  $5 \frac{3}{8}$  inches or a thicker sheet about  $2 \frac{1}{2}$  by  $9 \frac{1}{2}$ , and fold it in half.**

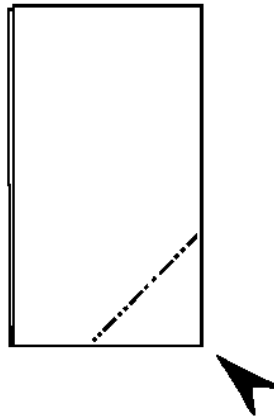

**2. Now, carefully fold and unfold (crease) a right angle triangle and then reverse fold (sink) it into the center. The bottom side of the triangle should be about  $\frac{3}{5}$  of the bottom width.**

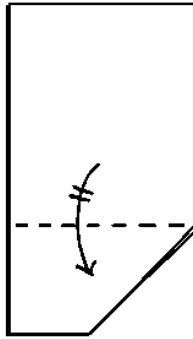

3. Fold down what will become the "wings".

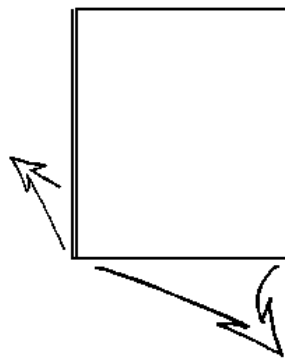

4. And open out fairly flat (but don't flatten out the creases very much).

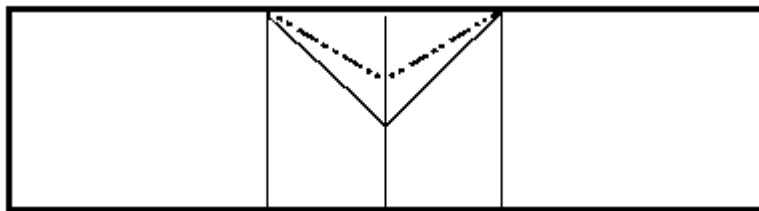

5. Reverse fold downward the front 3/5 of the triangle now sticking up in the center.





6. Without changing any folds, adjust their angles to produce a likeness of this and the next diagram. - make sure that the "wings" do not angle too much upward or downward, that the center structure is not too steep or shallow, etc. Also, make sure that the "wings" are flat, not warped by looking at them head on, as in illustration 7.

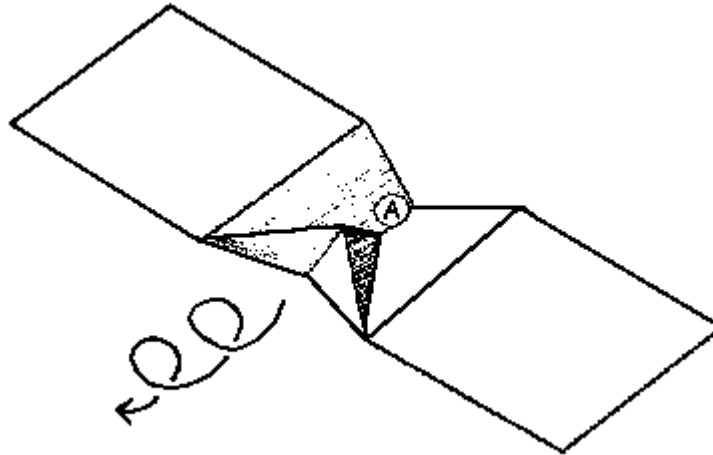

7. The ticker tumbler flies by tumbling over itself along a glide path - it is a good duration flier, and can be said to glide, since it has a glide ratio that's greater than 1. In fact it moves about 2 feet forward for every foot it drops.

You launch this unusual paper airplane in an unusual way: by holding at point "A" in fig.7, with your index finger above, and thumb and middle finger below. Quickly but gently "flick" it forward while at the same time pulling its back end down, to set it tumbling forward. (There's a knack to this)

Get the launch right, and you've got yourself not just a new flying toy, but a new kind of flying toy.

# Zump

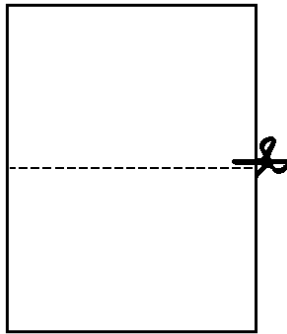
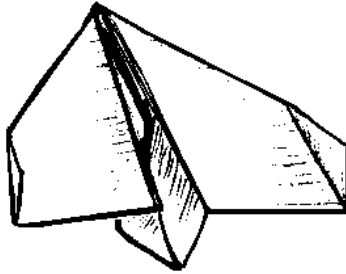

**1. Cut an 8 and 1/2 by 11 sheet of paper in half (to 8 1/2 by 5 1/2 inches) before starting.**

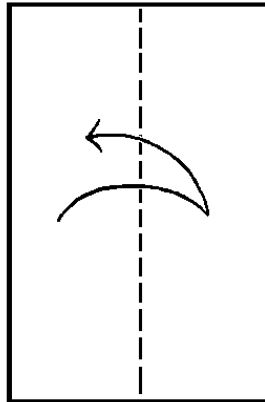

**2. Then take one of the two halves, turn it upright and begin by creasing it along the middle.**

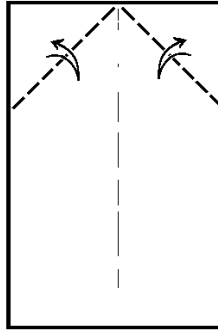

**3. Fold and unfold the top triangles as shown.**

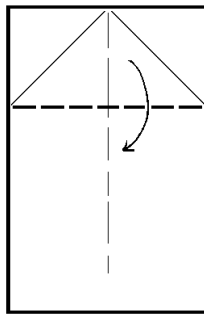

**4. Fold down the top along a line marked by the end of the creases just made in step 3.**

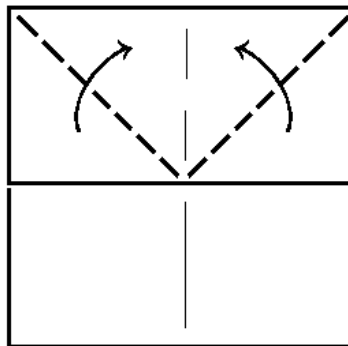

**5. And refold the now precreased corners (triangles) back up.**

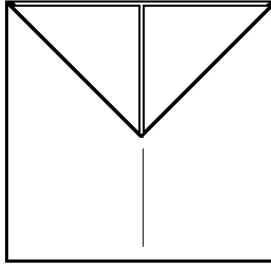

**6. Next...**

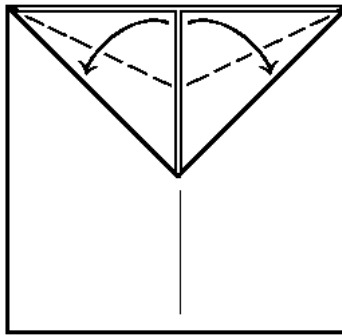

**7. Fold the two upper triangles in half, so as to bisect them, as shown.**

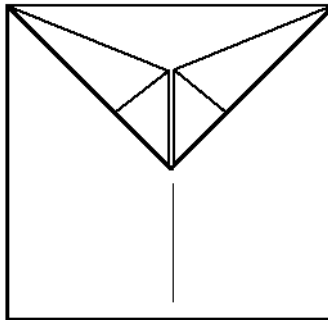

**8. Now...**

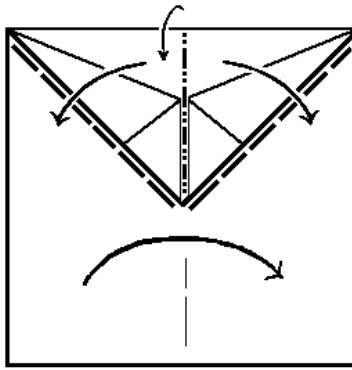

**9. Fold the upper large triangle up into the middle of the sheet, while folding the whole thing in half at the same time. (See diagram 10 on the next page to see you're trying to achieve with this.)**

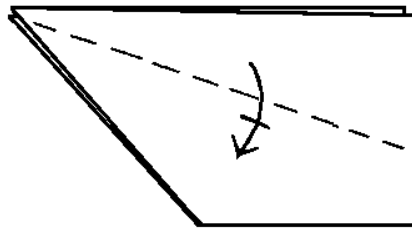

10. Fold down BOTH wings, approximately where indicated  
Note that this makes the wings a bit smaller than the body.

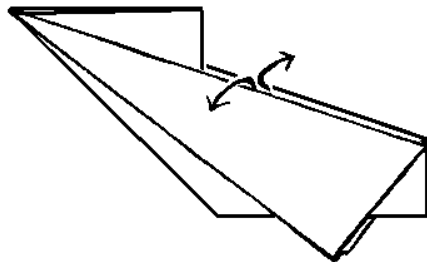

11. Carefully open up the paper airplane, keeping the center triangle together and to one side, with the smaller flap held against the opposite side as in diagram 12...

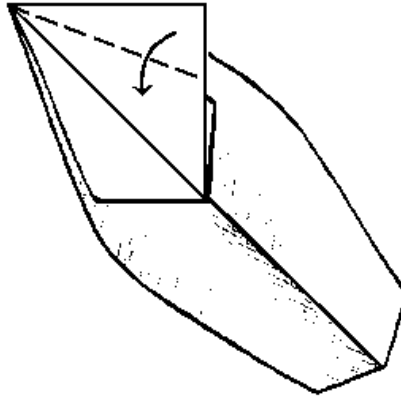

12. Now fold the center triangle in half, tuck it in, and fold the paper airplane flat again.

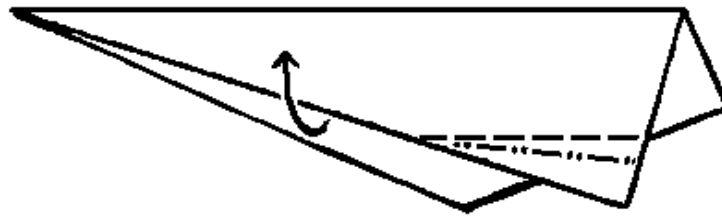

13. Crimp the wingtips as shown and lift the wings up so that they are angled slightly upward.

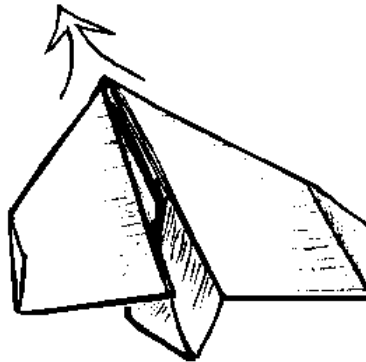

14. To launch, hold near the back, underneath, and don't try to fly the Zump too quickly.