

COMPARISON OF CORE HOUSE DESIGNS PROPOSED IN EGYPT

Prepared by:

Dr. Zakia Shafie, Cairo University

and Teaching Assistants Ahmed H. Sherif and Tolba Ragab Tolba

INTRODUCTION: CORE HOUSING

In the master plans of many of the new desert cities, sections of the residential areas were allocated to core houses, i.e. in Sadat City, Ameriyah New Town and 10th of Ramadan. Also, in the initial stages of rebuilding the canal zone cities after the 1973 war, i.e. Suez, Ismailia; sites and services projects with or without core houses were outlined in their planning proposals. In addition the Agency for International Development (AID) is financing a housing development in Helwan for low income inhabitants, and core houses of different sizes are proposed. The World Bank also is financing several core houses projects for very low income inhabitants; two sites were chosen, one in Alexandria and the other in Assiut. In the CU/MIT research team, the members dealing with housing for the low income and informal sector outlined proposals for core house designs (see: "Interim Report Working Papers 1978") which were based on the study of the informal housing areas around Cairo, (see: "Interim Report Working Papers 1977" which includes a survey of 6 low income areas in Cairo). This wide range of designs - usually with the participation of outside expertise - provides a unique opportunity to study the use of the core house for the low income.

This paper compares and evaluates the core house design proposals in their context as a proper building type for low income people. A detailed assessment of their characteristics and an analytical review of their potentialities is undertaken. From each of the proposed core houses in Egypt two examples were selected from the fore-mentioned planning, design, or research groups; one small lot situation and one large lot situation.

The 16 examples selected do not, by any means, represent all the types proposed but rather provide a similar or analogous sample in order to facilitate comparisons,

while at the same time covering a wide range of the different design aspects. The ground floor and first or typical floor plans of the 16 core houses selected are included in Appendix A.

Economy plays a great role in core house design. It is the goal of the planner and designer.

Views may differ on methods of application whether it is for economy in the initial cost or the long term. But all should offer the most appropriate dwelling for low income inhabitants. The range for minimum expenses of low income may vary from one situation to another; from the lowest low income to middle low income. This may account for the wide range of differences that was apparent in some of the analysis results. But it also displays the potentialities of the core house, and points out that this dwelling type could be appropriate for a wide range of low income inhabitants.

CONCLUSIONS

1. Small plots do not necessarily mean cheaper infrastructure costs per built-up m^2 , unless there is the possibility for future vertical expansion. Accordingly, there is a wide range of plot areas. The width is usually 6m; this is more consistent as it is one of the governing economical factors for infrastructure cost. Small plot areas average $54m^2$ and large ones $130m^2$.
2. Notwithstanding the plot size, there is a marked trend to allocate about 30% of the initially built core unit.
3. The number of habitable rooms in the initial core is usually one room plus bath and cooking area, or kitchen. Usually, the core area in small plots is 15 or $20m^2$ but in larger plots it might go up to 30 or $40m^2$. This means that the initial cost paid by the public authorities covers a minimum of built area.
4. The location of the core unit at the front of the plot is the most logical solution for economic reasons. The cost of connecting pipe lines is minimized. Also from the urban point of view, a more unified facade is maintained, which also makes it more acceptable to politicians.
5. It is much more economical if the designer takes into consideration the importance of future growth of the core house, whether horizontal or vertical. The core house with its minimum habitable facilities is only "Phase I" in the process of urbanizing a residential area. Thus, the easier is the process of expansion, the quicker the owner would build in the future, and the quicker would be the growth of the area thus making full benefit of the costly initial infrastructure. In the long run it might be more economical to have larger plots than smaller ones,
6. Flexibility of growth is closely tied with the construction. In skeleton construction if columns are placed shifted from the sides the building process for vertical expansion would be facilitated. Load bearing walls should not run parallel to the facade. This is in the case of the core occupying the full width of the plot. If the core is adjacent to one long side of the plot the duplication of bearing walls running the whole long length of the plot is avoided.
7. It is not enough to reduce the area of core unit for economy, the geometric shape of the core itself has a strong bearing on the wall surface necessary to enclose that space. One compact rectangular area is more economical than several combined rectangles.
8. The design of core unit which takes into consideration the possibility of vertical expansion of the habitable area as a separate entity (i.e., separate dwelling per foot floor) is much more economical in the future. This is assured by the proper placing of the staircase outside the dwelling unit on the ground floor, but not occupying the facade which is more appropriate for habitable rooms (see: "Interim Report Working Papers 1978").
9. For economic reasons, the kitchen and bath are sometimes placed at the front of the plot. This is not advisable as habitable rooms fronting on a street have far more value to the inhabitants. Not only should the kitchen and bath be placed adjacent to each other in the core, but also cores should be built as mirror images so that an economy in street man-holes could be maintained.

for the cost of infrastructure per family when the maximum contemplated built-up area is reached would be less for larger plots.

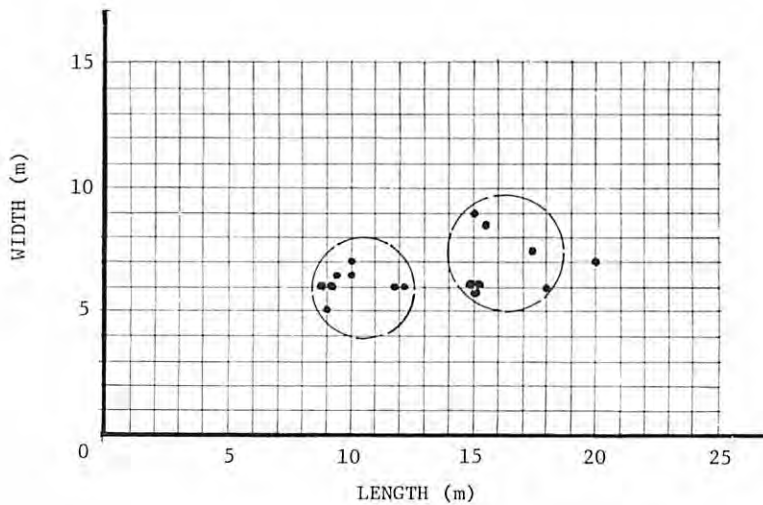

Figure 1: WIDTH/DEPTH RELATIONSHIP OF PLOT

It is evident that in all of the types proposed, plot lengths do not exceed 20 meters and width is not less than 9 meters. The range in width dimensions of the various plots of the 16 types are more limited (5 meters minimum - 9 meters maximum). Fifty percent of the plots are 6 meters in width, and eighty percent are between 6-7.50 m.

Plots proposed vary in area; while plot areas suggested by the World Bank in Assuit and MOH-AID in Helwan are quite small, those designed for the New Towns and the redevelopment areas in the Canal zone cities are much larger in contrast.

The small areas are approximately between 55 and 70 m², while the larger ones are between 90 and 130 m².

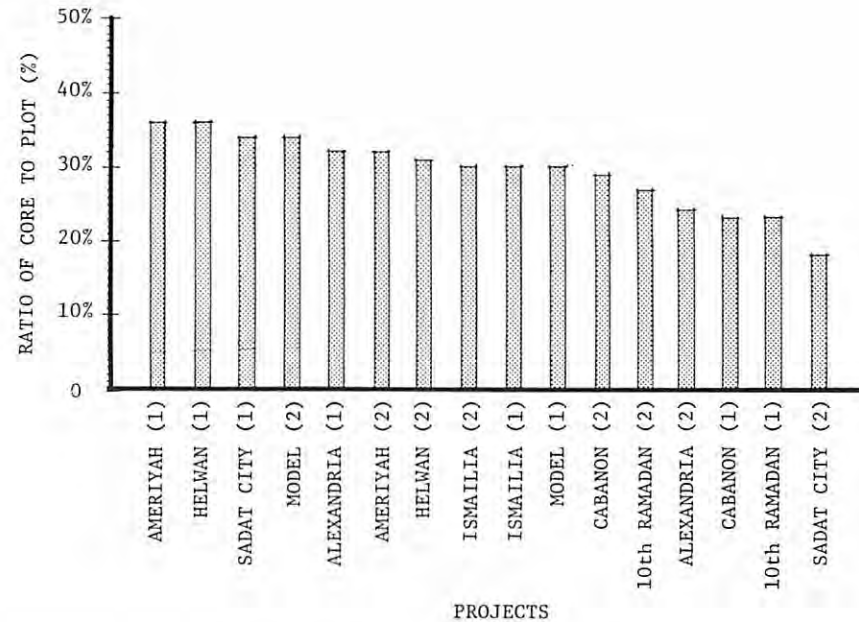

Figure 2: CORE AREA/TOTAL PLOT AREA RATIO

The design of the core itself - although composed of a few simple functional units - has many alternatives, except that in all of the 16 types the kitchen and bath are planned adjacent to each other.

Notwithstanding the variety in plot dimensions and plot area, or the location of the core within the plot, the ratio of core area to total area of is 30% (ranging from 27-32%), and in 75% of the types the ratio ranges from 27% to 36%.

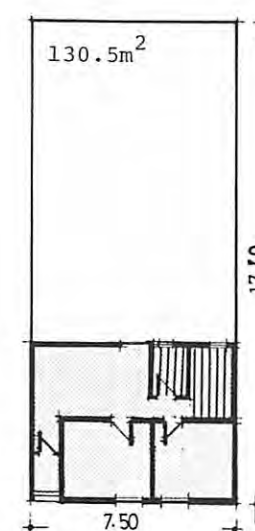
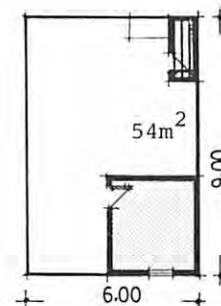
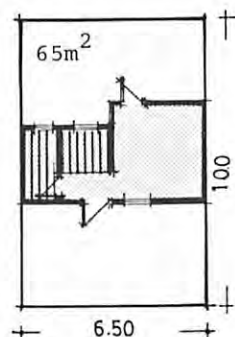
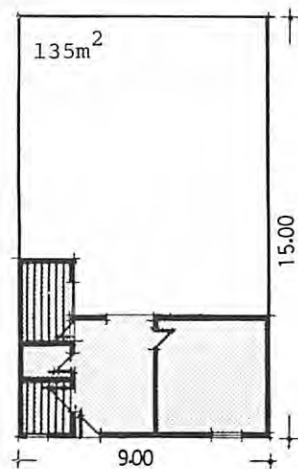
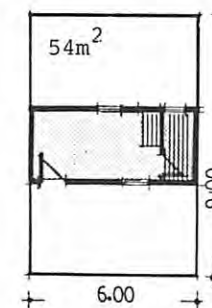
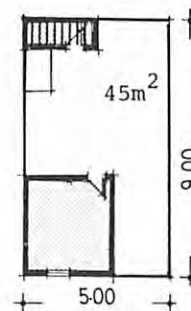
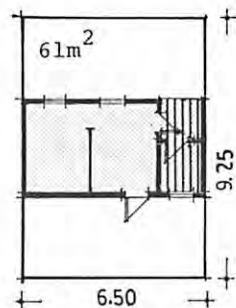
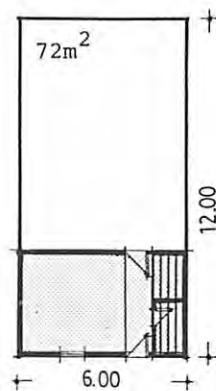

Figure 3: LOCATION OF THE CORE ON THE PLOT AND NUMBER OF INITIALLY BUILT ROOMS

KEY: Habitable Room Kitchen + Bath

The 16 core house examples are drawn at the same scale, each with the plot. The habitable area is shown dotted, while the core service area (kitchen + bath) is shown hatched. The area of each plot is indicated and also the width and depth of the plot.

There is a large variation in the location of the



ISMAILIA DEMONSTRATION PROJECT

HELWAN NEW COMMUNITY
(MOH-AID)

ASSUIT PROJECT
(MOH-WORLD BANK)

PROPOSED MODEL

core on the plot, although in 50% of the cases the core is located at the front. The other locations are: slightly shifted from the front (Suez), in the middle (MOH-AID, Proposed Model), at the back (Sadat City), at the side (10th of Ramadan, Ameriyah) or even split having the room on the front and the core service at the back (Alexandria).

In all of the small plots only one habitable room serves all purposes. In the larger plots, a hall and one or two rooms are provided.

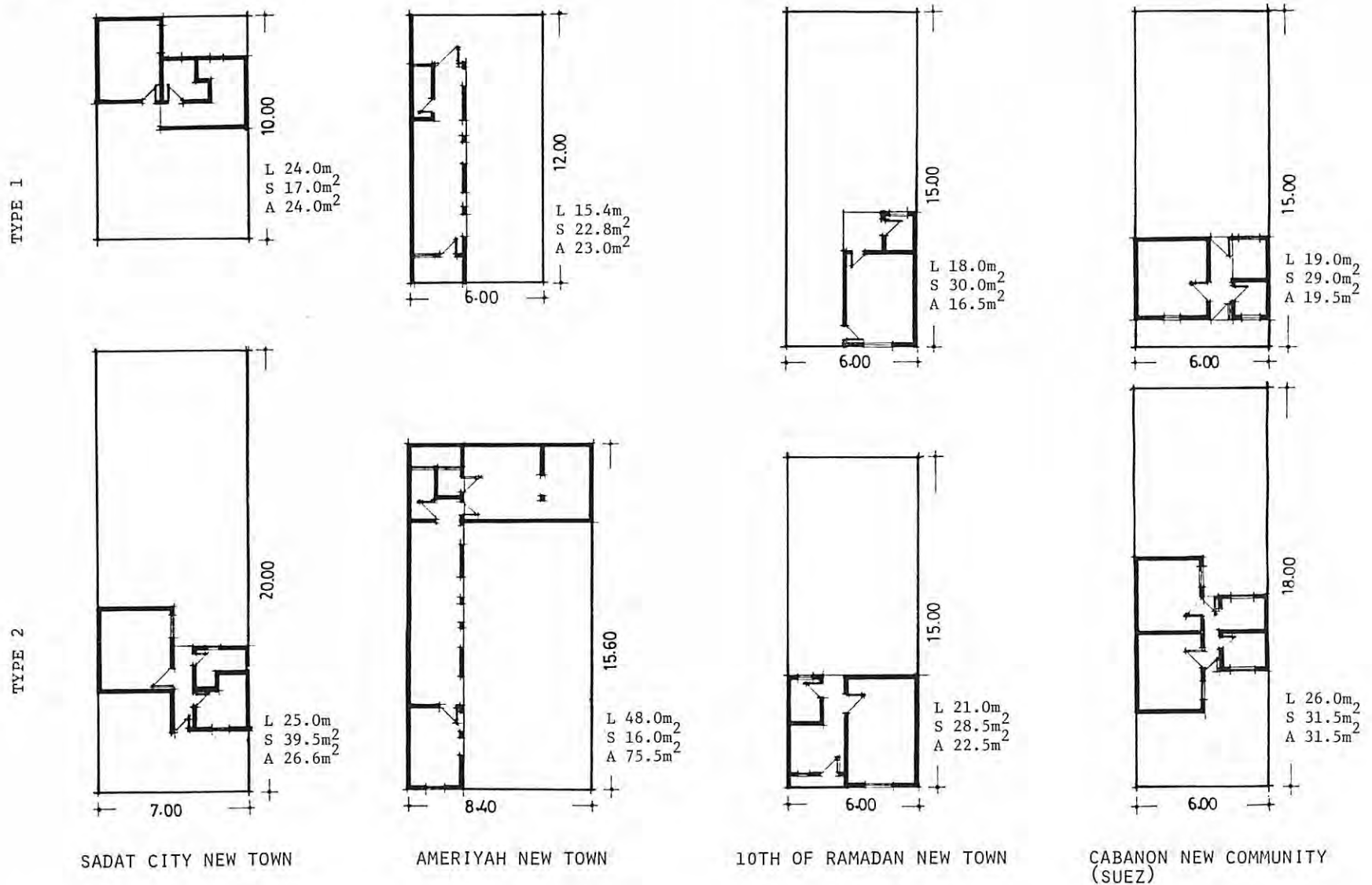
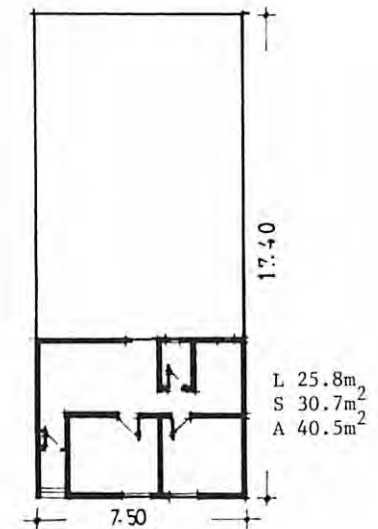
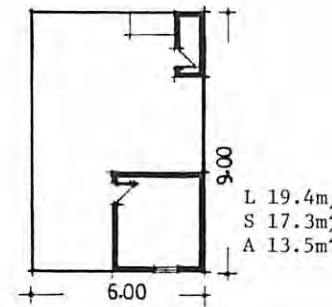
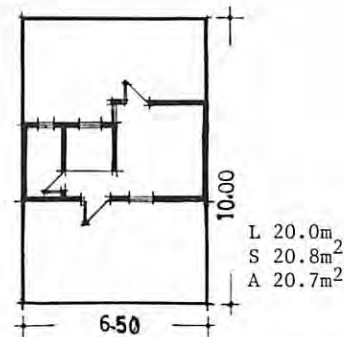
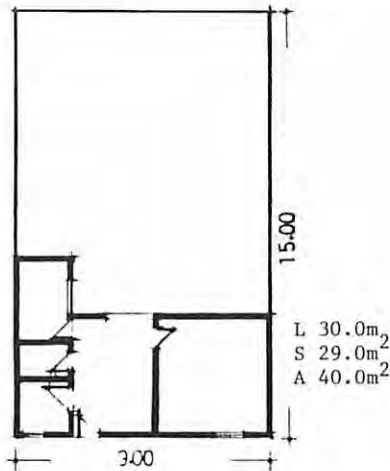
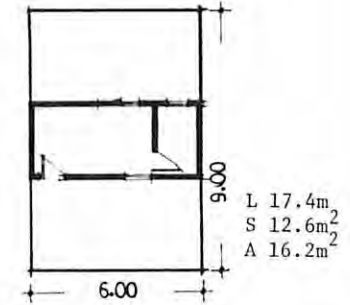
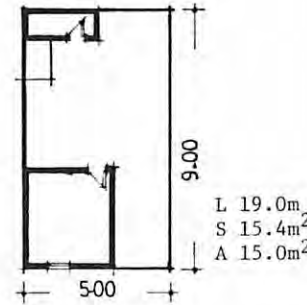
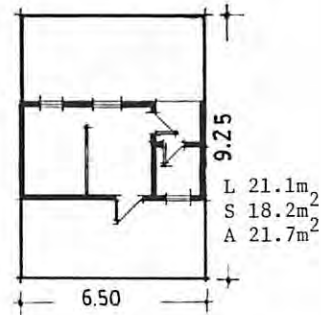
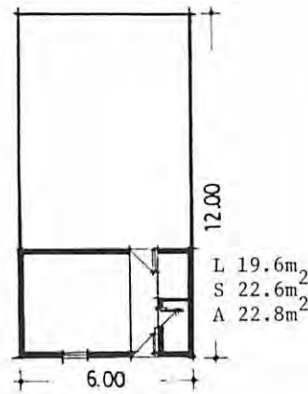

Figure 4: WALL AREA OF CORE

KEY:
 L = outer wall length
 S = outer wall surface area
 A = core area

It is clear that the shape of the core affects the relationship between the surface area of its enclosing walls and the area of the enclosed space itself. Thus, for areas nearly equal but different in their geometric shapes, we find a difference in the surface areas of their outer walls. Also, for the same surface area of walls, we find



ISMAILIA DEMONSTRATION PROJECT

HELWAN NEW COMMUNITY
(MOH-AID)

ASSUIT PROJECT
(MOH-WORLD BANK)

PROPOSED MODEL

that it can enclose functional spaces of unequal area.

To illustrate, compare most World Bank Type 1 with the Proposed Model Type 1, having nearly the same core area of 15 m² and 16.2 m². We find that the first with a smaller area needs more enclosing outer surface walls (19 m x 3 m height = 57 m²), while the second requires less

(17.4 m x 3 m height = 52 m²).

Also, comparing Sadat City Type 2 with the Proposed Model Type 2 both with the same outer wall length of 25 m, and an outer wall surface area of 75 m², we find the enclosed core area of the first 26.6 m², while the second has 40.5 m².

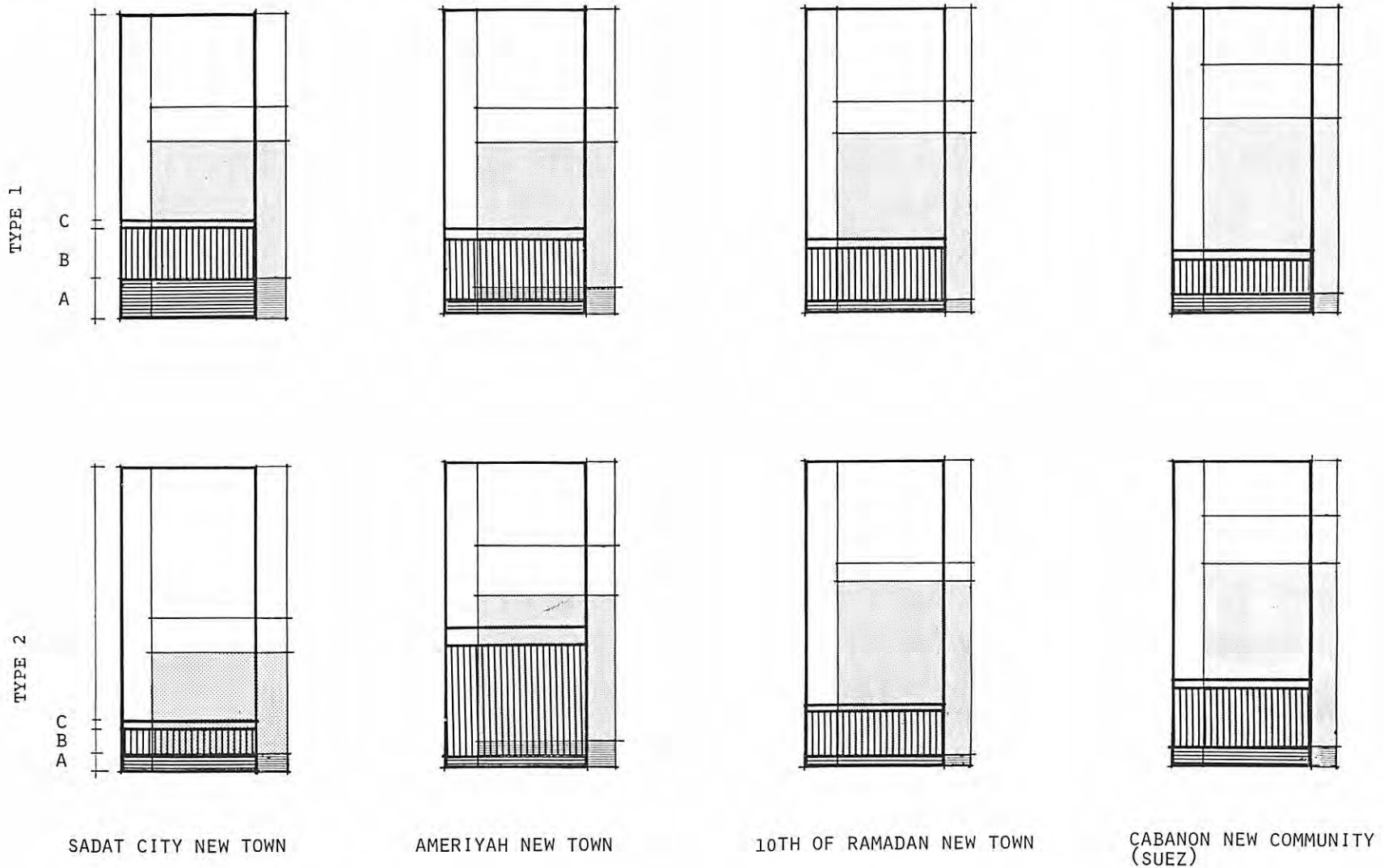
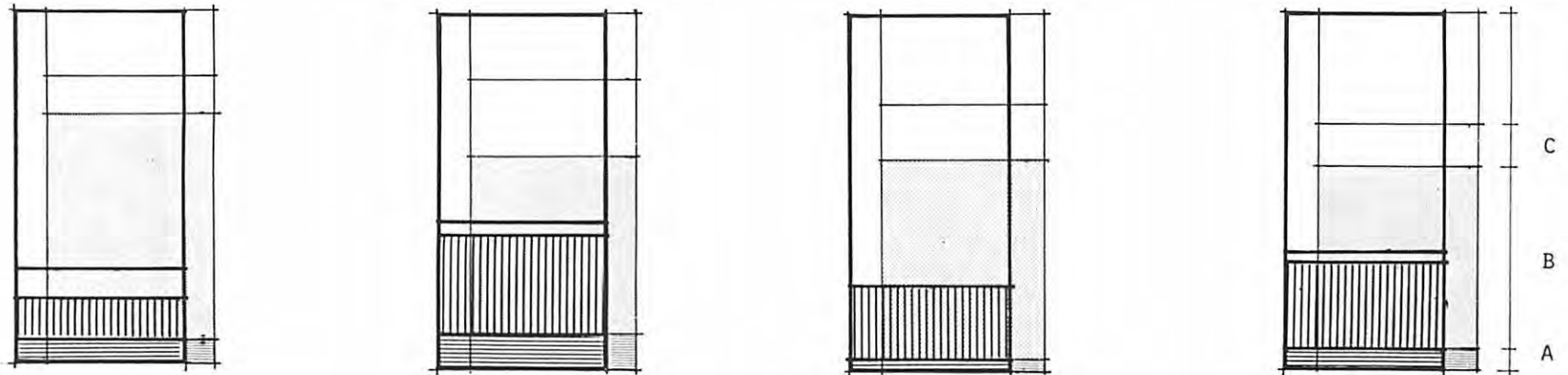
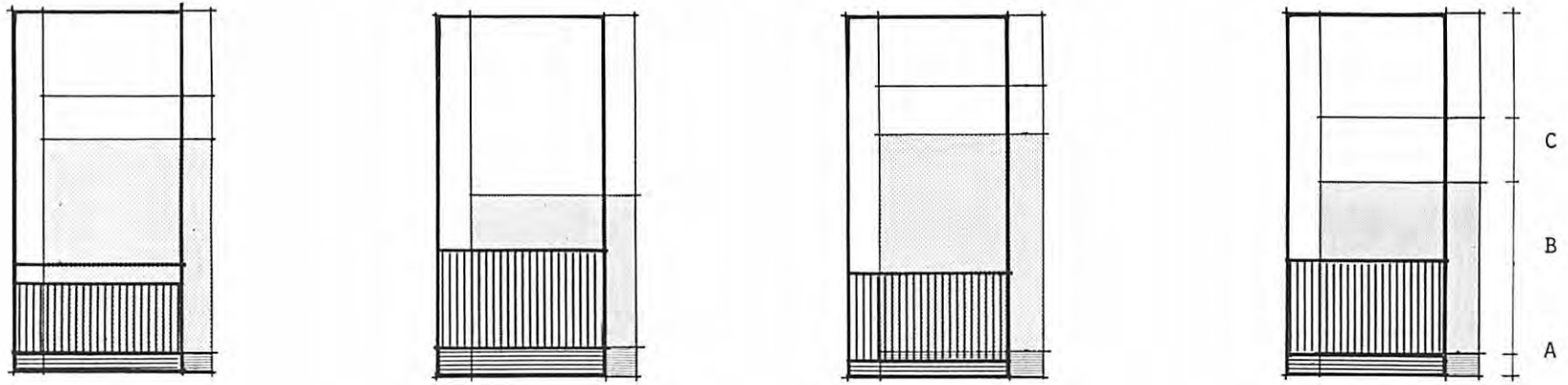

Figure 5: FUNCTIONAL RELATIONSHIP OF PLOT

The 16 examples are drawn in a uniform rectangle, representing 100% of the area, with their specific functions of core service A (hatched horizontally), habitable rooms B (hatched vertically), and circulation C (not hatched)

drawn as a ratio to the total plot area in order to facilitate comparison. The offset rectangle illustrates the same functions (core service hatched horizontally, habitable rooms dotted) when full horizontal expansion is realized, i.e., when the ground floor is totally built.

In Type 1 the circulation area in the initial core



ISMAILIA DEMONSTRATION PROJECT

HELWAN NEW COMMUNITY
(MOH-AID)

ASSUIT PROJECT
(MOH-WORLD BANK)

PROPOSED MODEL

unit is negligible, and in 40% of the cases the circulation is either through the court or through the habitable room itself. There is a uniform pattern for allocation of functions within the plot except in Sadat City Type 1 which has a very large core area in comparison to habitable room. In Type 2 it shows the lowest intensity of use of the site

which does not reflect the low income economy, which is quite in contrast to Ameriyah Type 2.

The area allocated to circulation for the ground floor in the finished phase is larger in some types than in others because of the space allocated for staircase access to the upper floors.

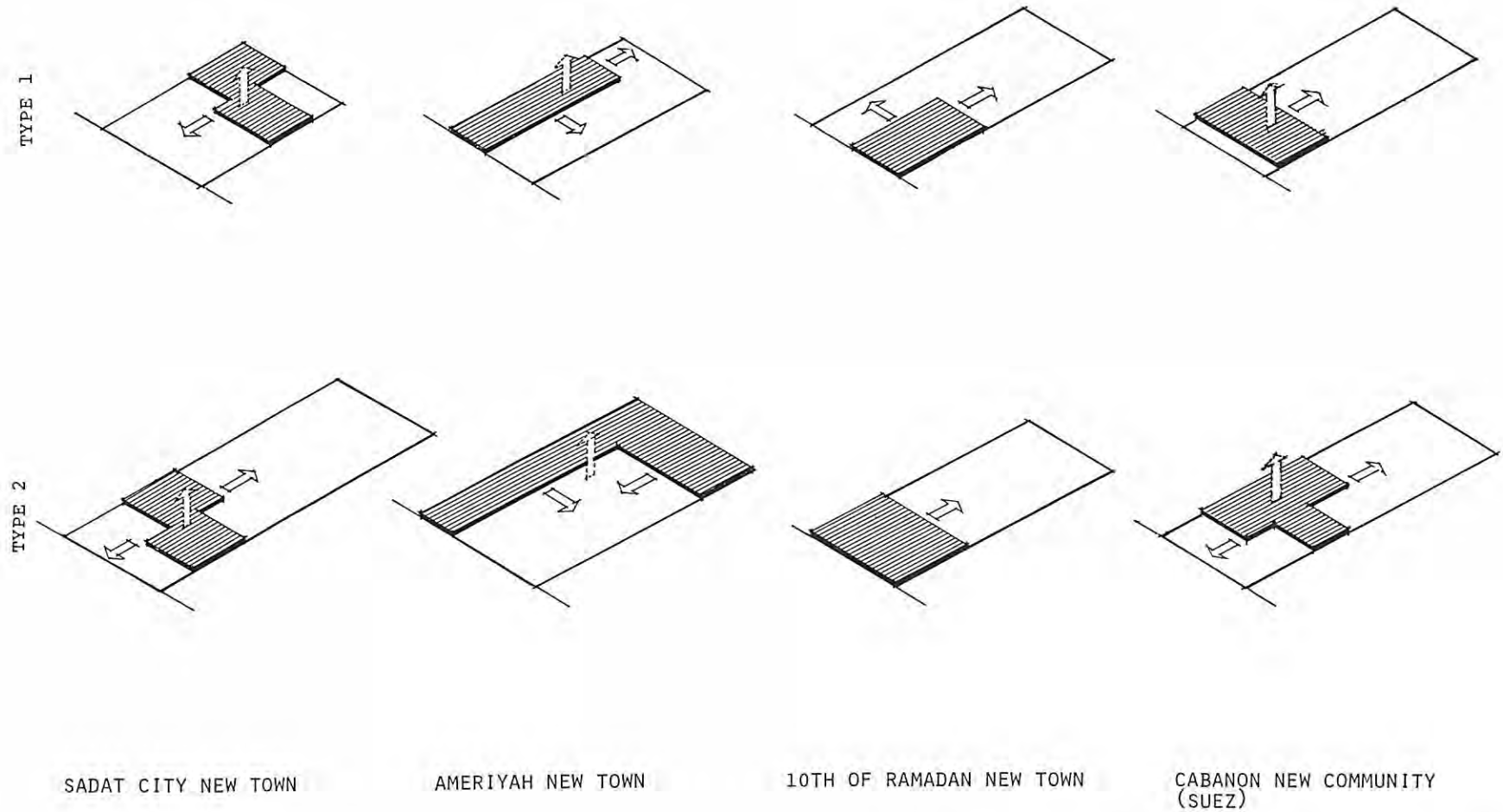
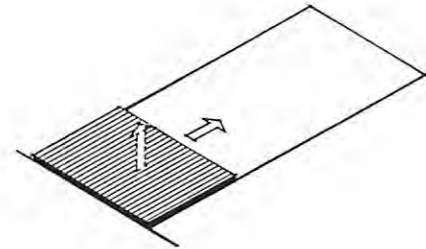
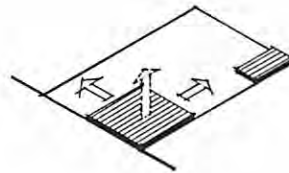
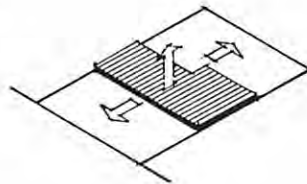
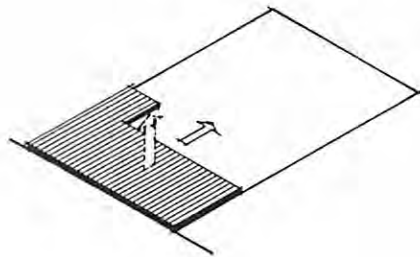
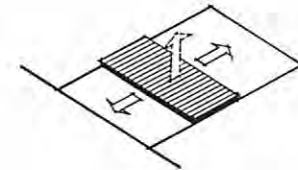
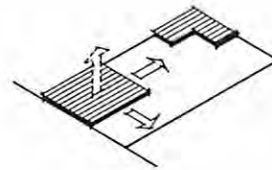
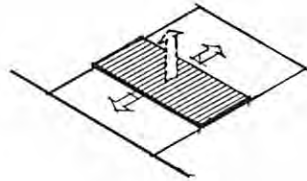
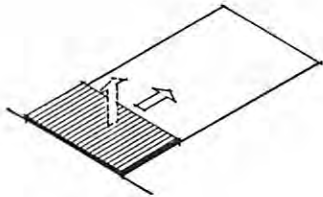

Figure 6: GROWTH FLEXIBILITY

The 16 examples are drawn in isometric form with continuous arrows indicating horizontal expansion and dotted arrows indicating vertical expansion.

The location of the core unit in the middle of the site offers several options and possibilities of expansion, while the location of the core at the front or at the back



ISMAILIA DEMONSTRATION PROJECT

HELWAN NEW COMMUNITY
(MOH-AID)

ASSUIT PROJECT
(MOH-WORLD BANK)

PROPOSED MODEL

offers one direction only for expansion.

The larger the width of the site the more flexible is future expansion. It offers many options and several varieties for expansion (see Proposed Model Type 2, Appendix A).

The more compact the core unit, the easier it is for

future vertical expansion. In the MOH-World Bank Type 1 and 2 with a split core, vertical expansion is not a typical plan of the ground floor, it is on the front with a different location of core service (see Appendix A).

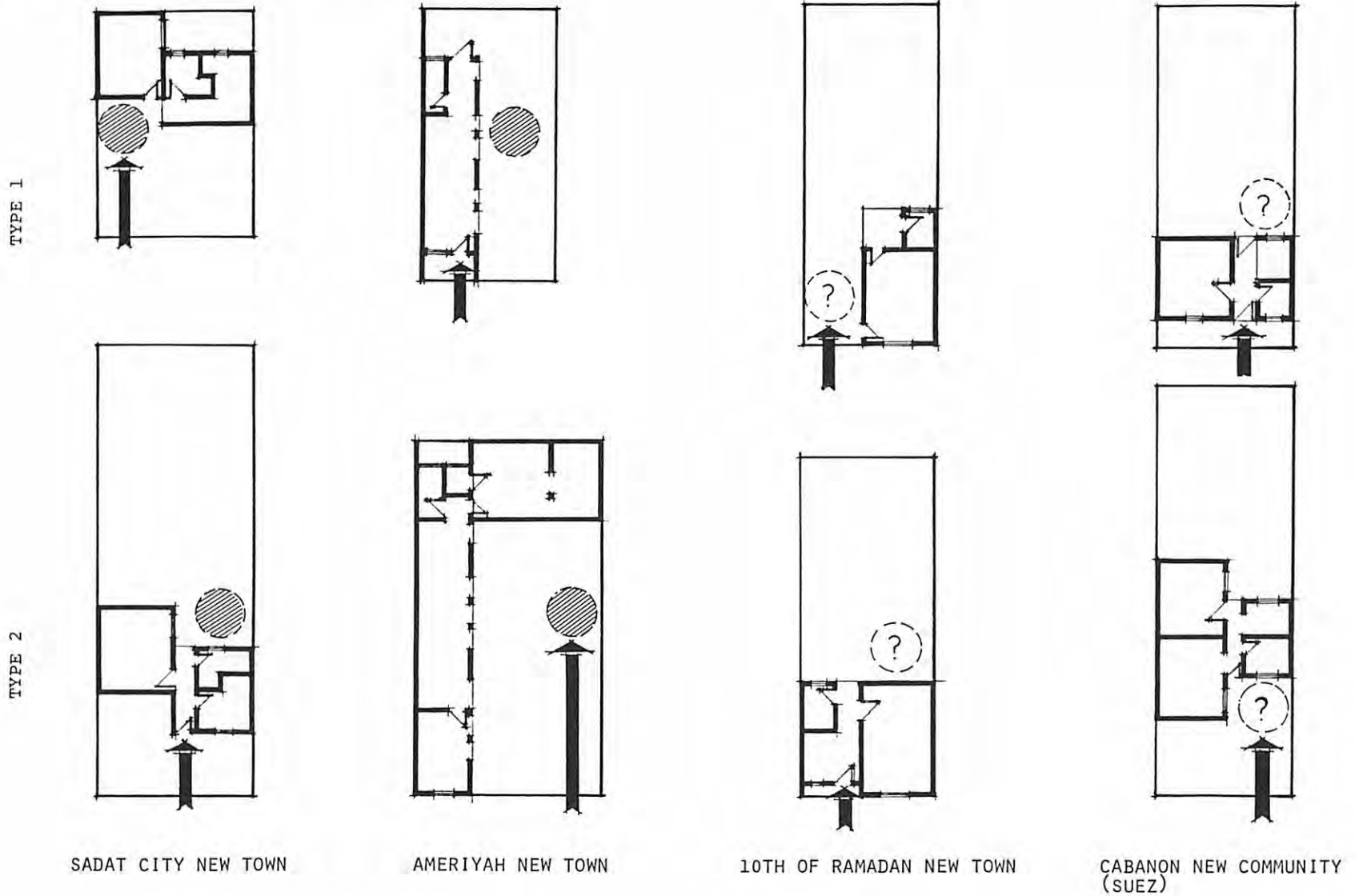
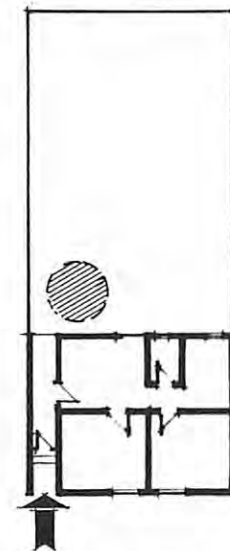
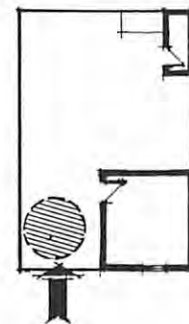
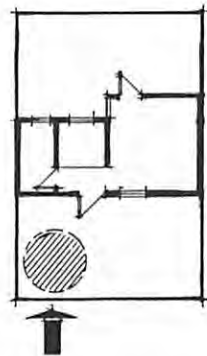
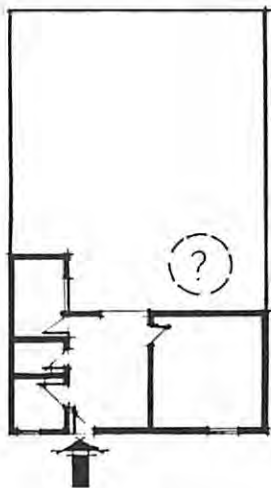
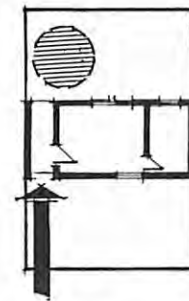
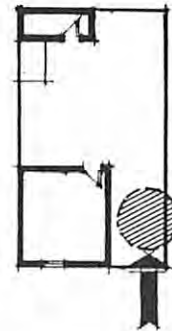
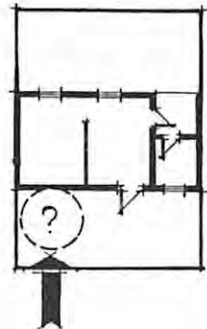
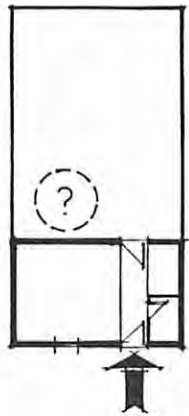

Figure 7: STAIR ACCESS TO UPPER FLOORS

The 16 examples are drawn with an indication of contemplated or possible staircase location (a hatched circle is drawn).

For possible (but not planned) staircase location a question mark within a circle is drawn. The black arrow indicates the entrance from the street.



ISMAILIA DEMONSTRATION PROJECT

HELVAN NEW COMMUNITY
(MOH-AID)

ASSUIT PROJECT
(MOH-WORLD BANK)

PROPOSED MODEL

It is obvious from the examples that some of the designs take into account the location of the staircase for future vertical expansion as a separate dwelling having a direct access from the street, while in others one crosses the core unit in order to reach the staircase. Thus privacy can not be maintained and vertical expansion

would be a continuation of the same dwelling on the ground floor and not a separate dwelling, which would be used for rental purposes.



Figure 8: MAXIMUM DEVELOPMENT/INITIAL DEVELOPMENT RELATIONSHIP

The 16 examples are drawn in rectangles at a constant width while maintaining their true area for easier comparison. The initial core area is striped A, while the maximum contemplated built area is shown dotted B. The number of floors is written beside each rectangle.

It is evident that in Type 1, which has a small plot,

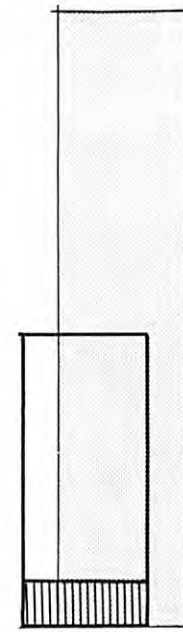
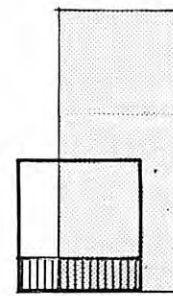
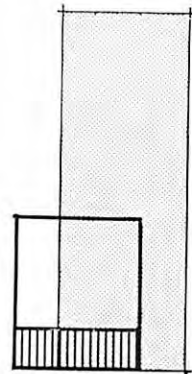
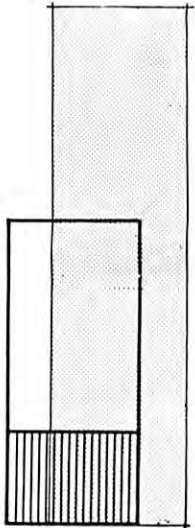
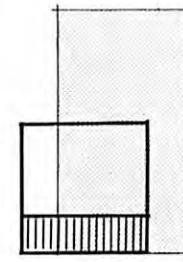
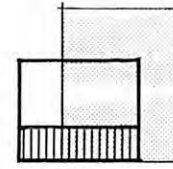
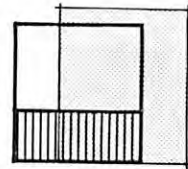
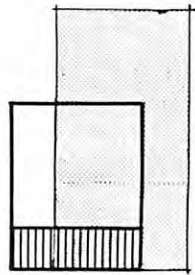

ISMAILIA DEMONSTRATION PROJECT

HELWAN NEW COMMUNITY
(MOH-AID)

ASSUIT PROJECT
(MOH-WORLD BANK)

PROPOSED MODEL

the finished area is rather small as it has a limited possibility of expanding vertically.

In 10th of Ramadan New Town, no vertical expansion is apparently contemplated.

In Type 2 there is a marked variety in the expected intensity of use of the site while in Ameriyah and in

the Proposed Model maximum built-up is a ground floor + 3 floors, while the others only expect vertical expansion for one or two floors.

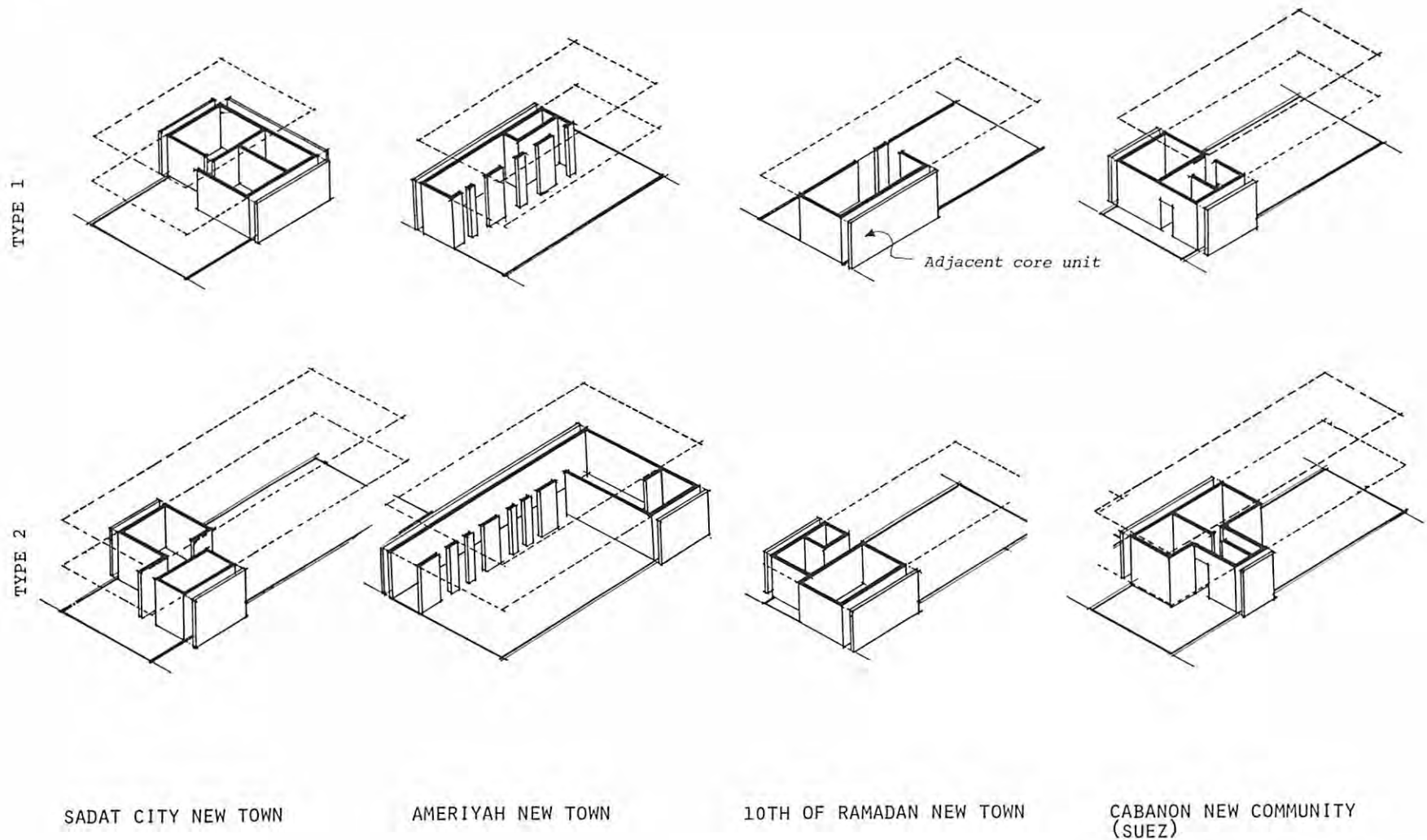
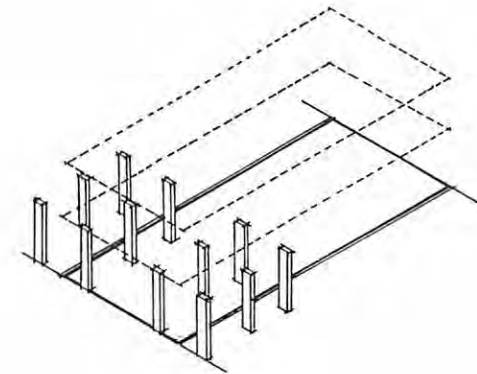
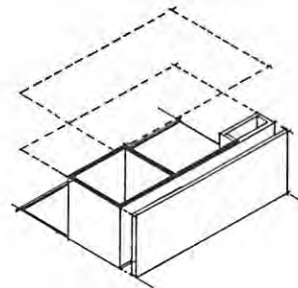
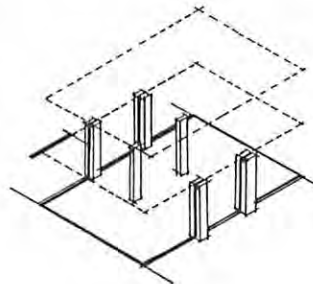
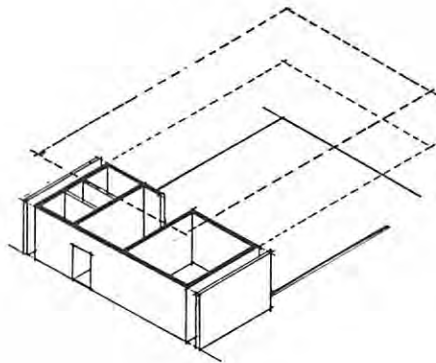
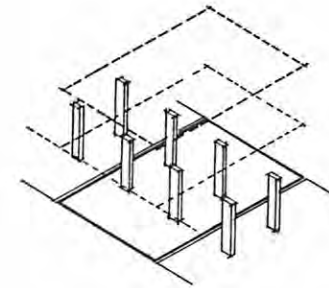
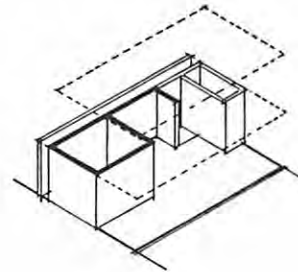
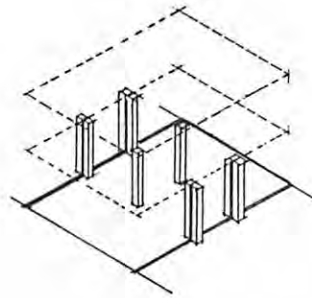
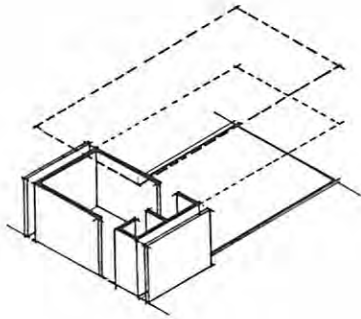

Figure 9: CONSTRUCTION

The 16 examples are drawn isometrically showing their construction.

1. Load bearing walls, which are found in the majority.
2. Skeleton construction, MOH-AID, and in the Proposed Model
3. Prefabricated load bearing walls, in Ameriyah New Town.



ISMAILIA DEMONSTRATION PROJECT

HELWAN NEW COMMUNITY
(MOH-AID)

ASSUIT PROJECT
(MOH-WORLD BANK)

PROPOSED MODEL

It is inherent in the idea of core house that the owner will eventually expand his dwelling horizontally, and also vertically as proposed in many of the types.

If the columns are slightly shifted inside the site in the skeleton type, the owner can easily expand vertically and the number of columns are reduced from 3 in a row to

2 in a row. Thus, reducing the total number from 9 to 6 reinforced concrete columns (see Proposed Model Type 1 and 2). This, of course, is dependent on the structural requirements of the width of the lot. Moreover, the width is critical to ensure that columns do not penetrate rooms, or in other awkward positions.

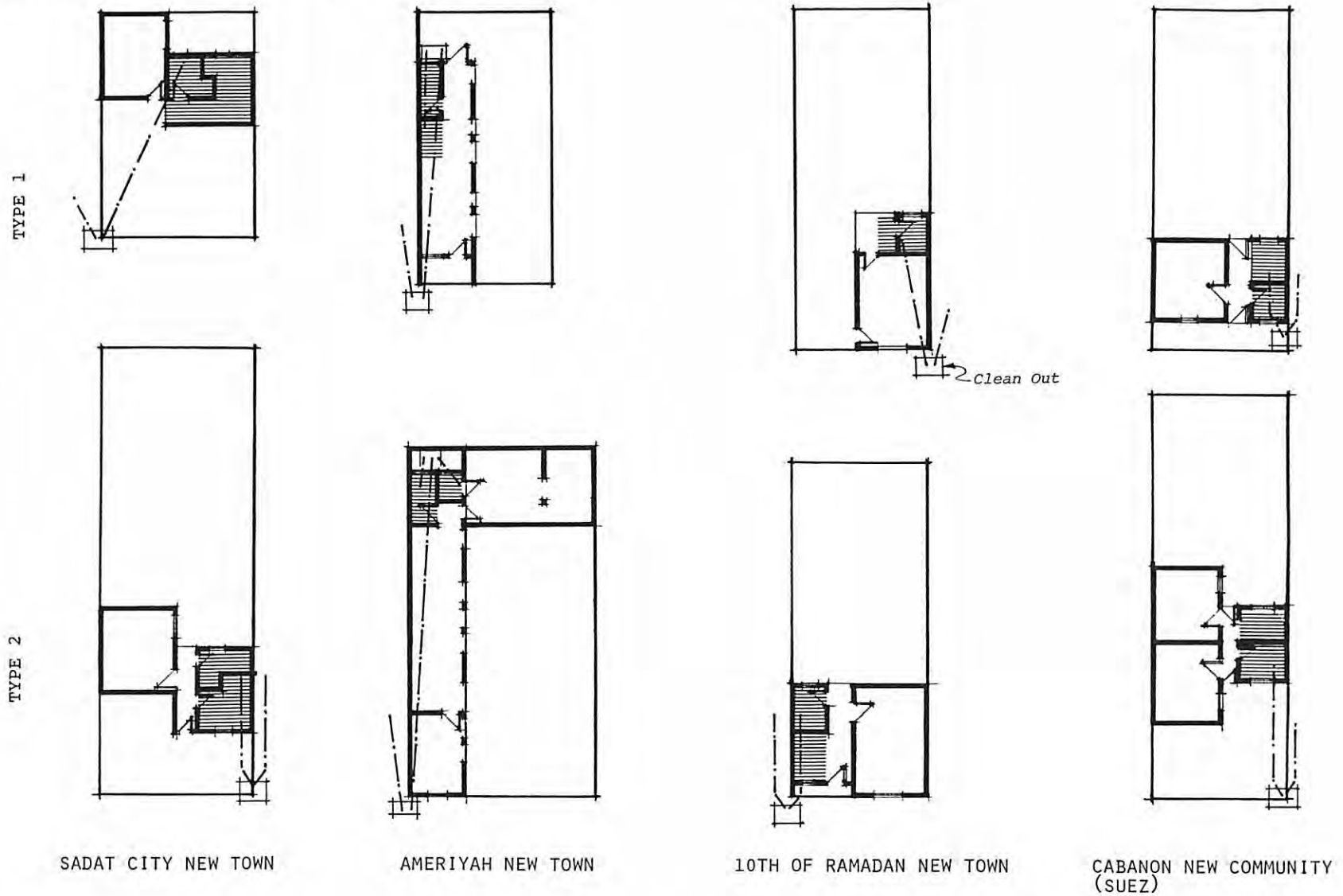
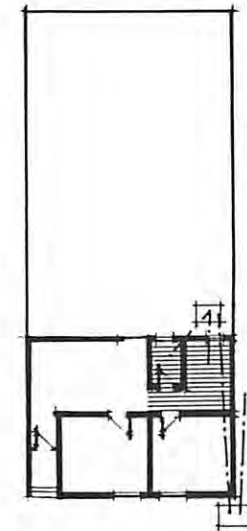
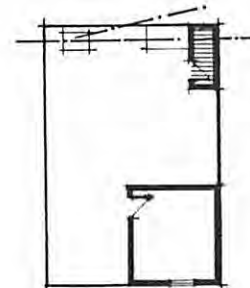
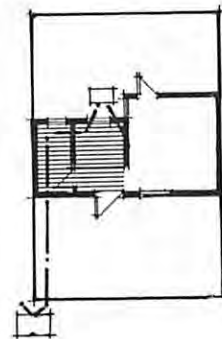
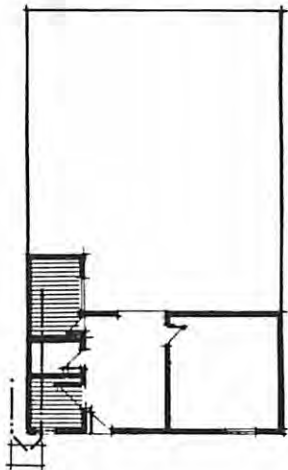
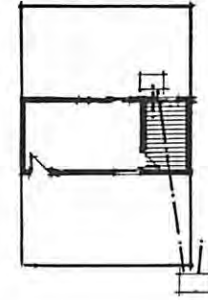
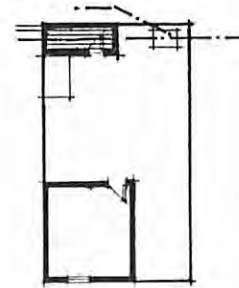
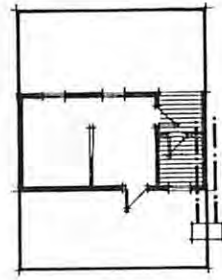
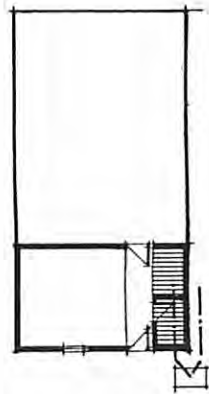

Figure 10: UTILITIES/SEWAGE

The 16 examples are drawn with their core service (bath + kitchen or cooking space) hatched horizontally. Note that the location of the core service within the plot has a direct bearing on the construction length of plumbing lines.

- Core service at the front of plot: piping is minimum



ISMAILIA DEMONSTRATION PROJECT

HELWAN NEW COMMUNITY
(MOH-AID)

ASSUIT PROJECT
(MOH-WORLD BANK)

PROPOSED MODEL

and simple. It is connected directly to the main pipes in the street.

- Core service within the middle part of the site: piping is longer; they are laid through courts or entrances (MOH-AID Type 2, Sadat City Type 1, Suez Type 2), or they are laid under the already built habitable room (10th of

Ramadan Type 2, Proposed Model Type 1,2). This is to avoid the area anticipated for future construction.

- Core service at the back: Long pipe lines pass under habitable areas and connect to the main street system (Ameriyah Type 1,2), or connect to pipes in easements running along the back of the plots (MOH-AID Type 1,2).

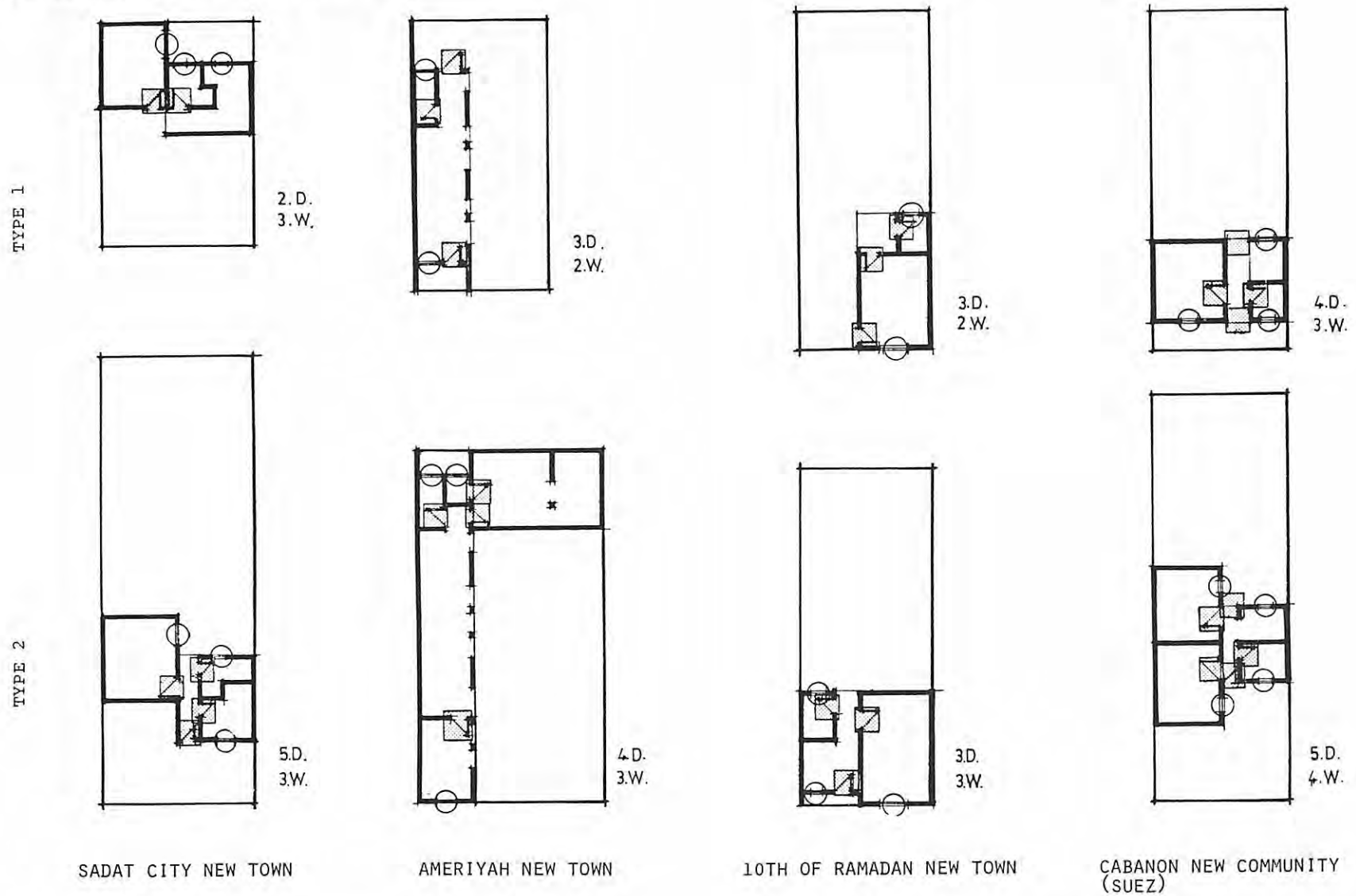
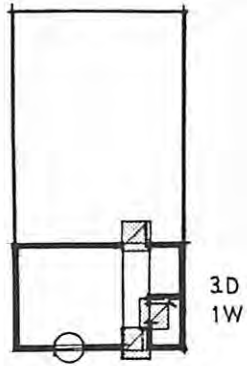
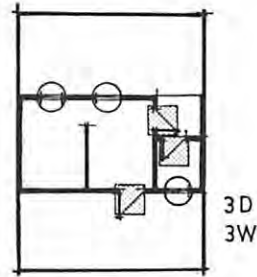

Figure 11: NUMBER OF DOORS AND WINDOWS

The 16 examples are drawn with the doors indicated by squares and the windows by circles. There is a wide variety in the number of doors and windows allocated within each type. MOH-WB Type 1,2 are the most economical but the bathrooms do not have a window, relying on ventilation through the door. Sometimes cooking



3D
1W



3D
3W

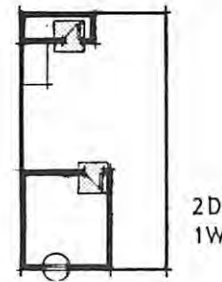

2D
1W

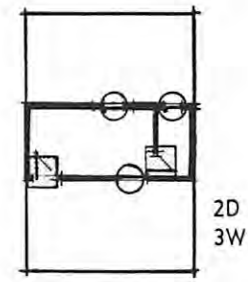

2D
3W

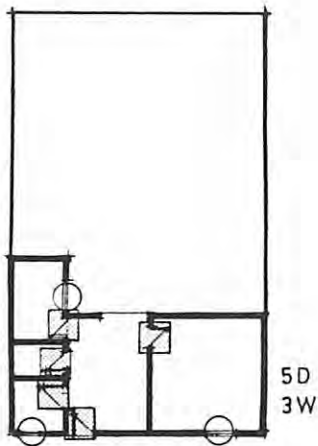

5D
3W

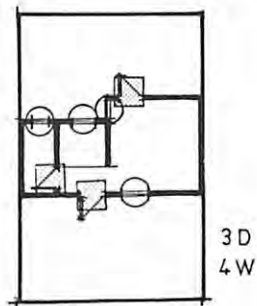

3D
4W

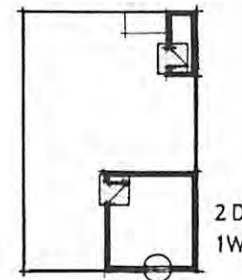

2D
1W

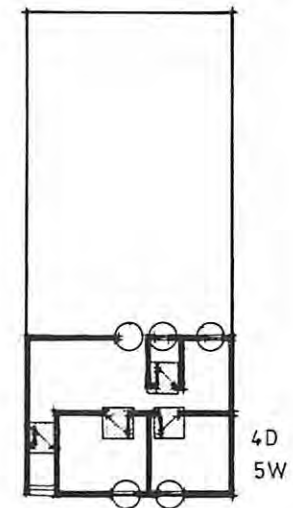

4D
5W

ISMAILIA DEMONSTRATION PROJECT

HELWAN NEW COMMUNITY
(MOH-AID)

ASSUIT PROJECT
(MOH-WORLD BANK)

PROPOSED MODEL

is done under shelter in the open court, i.e., no walls, doors or windows are necessary as in MOH-WB Type 1,2, 10th of Ramadan Type 1, MOH-AID Type 1.

Sometimes cooking is undertaken within the habitable area or adjacent to it as in Ismailia Type 1, Proposed Model Type 1, Ameriyah Type 1. Mostly the kitchen occupies

a special space and is not closed by a door.

INTRODUCTION: VERTICAL CORE HOUSING

In the planning for rebuilding Port Said after the 1973 war limited sites appropriate for low income housing projects were available. In addition, soil conditions were generally poor and required expensive foundations. A site adjacent to surrounding lake was finally chosen. For lowering expenses, a core house "apartment type" was designed instead of the core house "plot-type". Essentially, this type is a semi-finished structure: Floor slabs and a central stairway and utility core are completed, but further internal divisions and the outside walls are built by the users as desired.

Previous research (see "Interim Report Working Papers 1978") has also proposed core house apartment type which has a flexible plan and could eventually accommodate apartments of different sizes, expanding from a central service core (Appendix B). This model is also included to show another variation of the same approach with a more generous (higher cost) design.

A detailed assessment of the characteristics and an analytical review of the potentialities of the vertical core house follows, in order to point out the differences between core house "apartment type" and core house "plot type".

CHARACTERISTICS OF VERTICAL CORE HOUSING

1. The economic argument against using core houses is the alleged high initial cost of infrastructure compared to the low density of inhabitants of the initial phase in the development. "Core House" apartments could be the answer. The core unit is the only finished area in the 4 story building, and the users expand as needed, within the floor area limitations.
2. Unkept waste land between blocks in the usual public dwelling types is avoided.
3. Horizontal flexibility of expansion is maintained for each owner.
4. Contemplated non-built area could vary in the same building, thus giving a variety of different dwelling sizes.
5. The design pattern of the apartment buildings could generate variable layout designs, these could create more individual identifiable communal spaces. They also could be planned in sites of different areas and proportions. Their flexibility to adapt to many patterns of layout is contrary to the usually rigid pattern applied in public housing layouts of paralleled and perpendicular thin, slab blocks.
6. Construction could be by any structural methods, traditional = skeleton or load bearing, or prefabricated columns or walls and ceilings in factories or on site, i.e., tunnel form, etc.
7. Cost per dwelling is more reduced than in the core house by the increased sharing of the users, i.e. stairs, walls, and water and sewage networks.

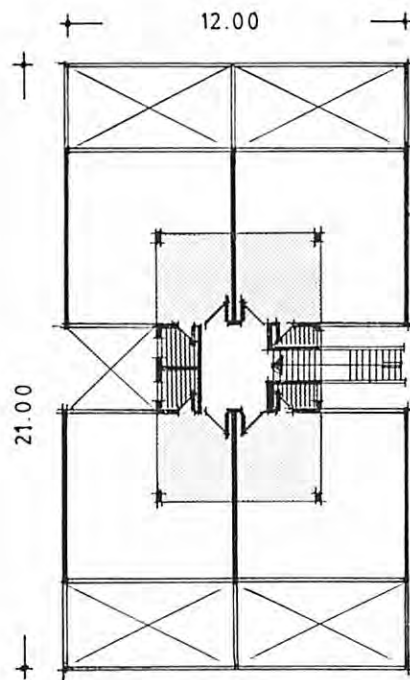

PORT SAID PROJECT

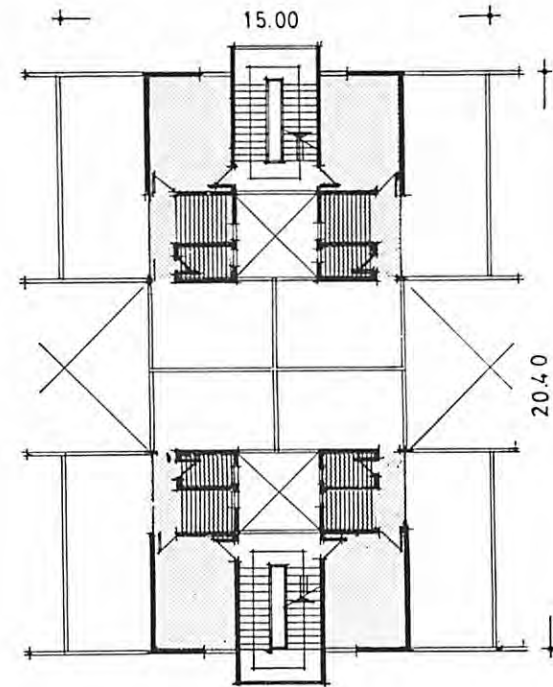

PROPOSED

Figure 1: CHARACTERISTICS

The two types are drawn the location of the core within the built-up area. Both cores are located near the stair entrance.

The number of habitable rooms are one in both cases. The Port Said design has just a roof shelter over a room. The Proposed Model has an enclosed space with 2 doors and a window.

The area of core for the Port Said design is 11.25 m^2 and in the Proposed Model it is 21.6 m^2 . The Port Said design does not include a kitchen, cooking could be done under the sheltered roof within the habitable area or on the open roof. Outer walls are $24 \times 3 = 72 \text{ m}^2$ for the Proposed Model while in the Port Said design it is only 15 m^2 . This is due to the habitable room having two open sides without walls.

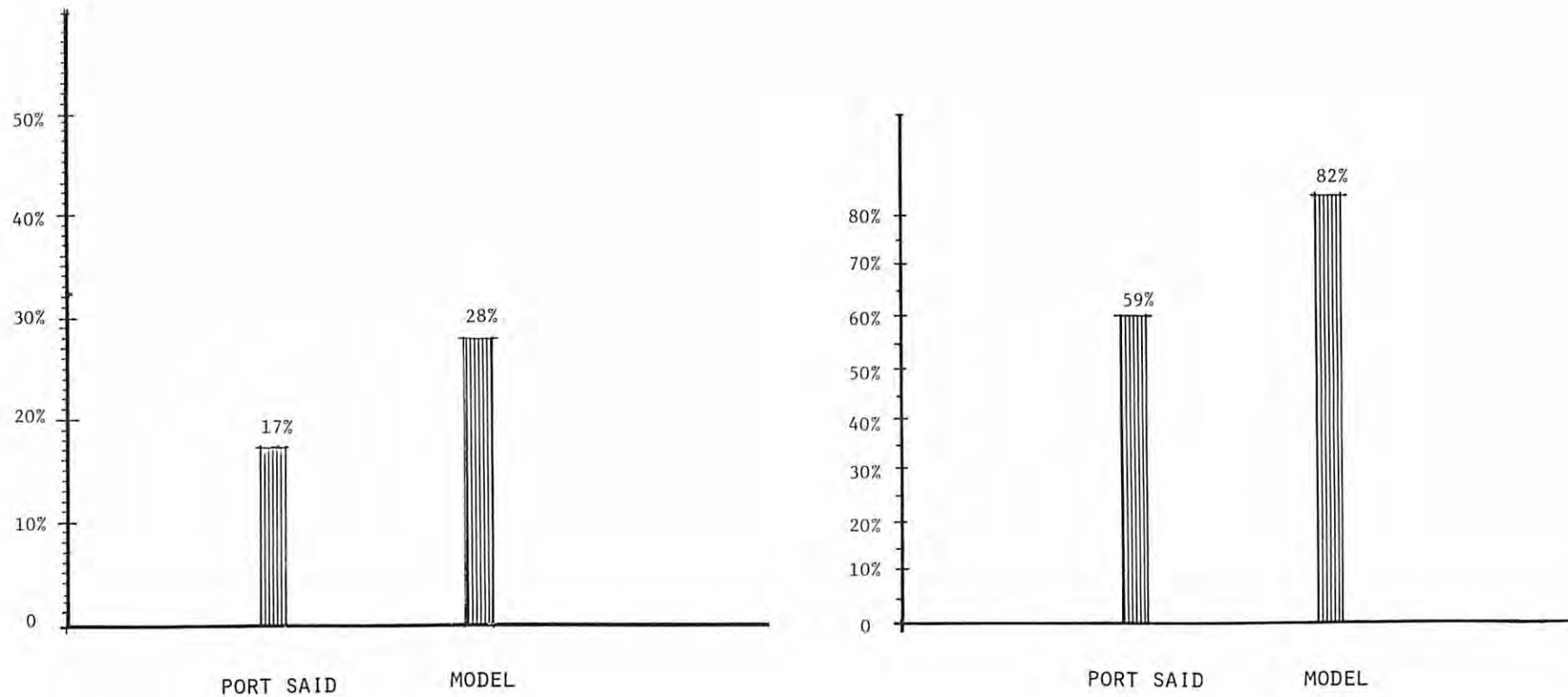
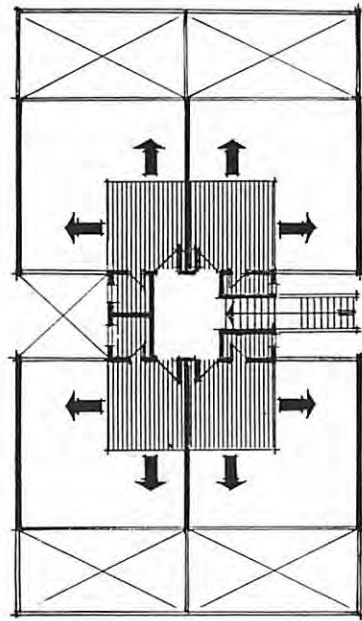

Figure 2: CORE AREA/TOTAL AREA RATIO

The area of the core is drawn as a ratio to the area of the plot; i.e., Port Said $12 \times 21 = 252 \text{ m}^2$ divided by 4 = 63 m^2 . Area of core = 11.25 m^2

Ratio = $\frac{11.25}{63} \times 100 =$ nearly 18%, and in the Proposed Model, 28%.

The latter is more in accordance with the core house plot type.



PORT SAID PROJECT

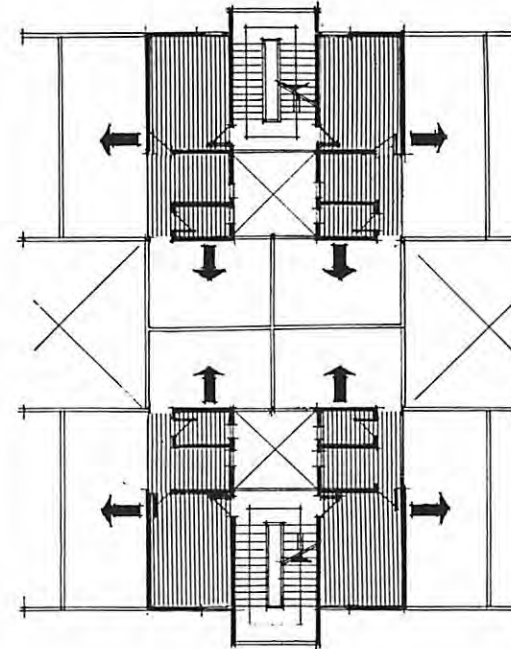

PROPOSED MODEL

Figure 3: FLEXIBILITY OF GROWTH

The two types are drawn indicating the possibilities of horizontal expansion as shown by the arrows.

Both can expand in two directions, but the amount of expansion is limited in the Port Said design and quite variable in the Proposed Model. (See Appendix B)

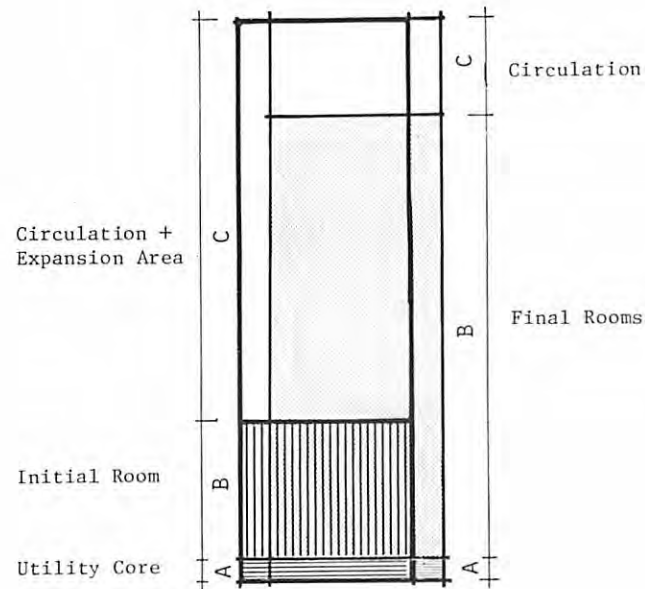

PORT SAID PROJECT

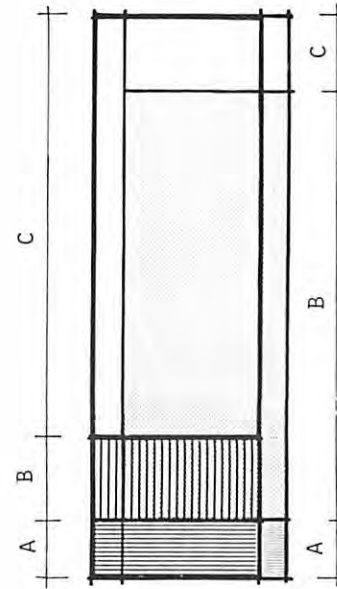

PROPOSED MODEL

Figure 4: ALLOCATION OF AREAS TO SPECIFIC FUNCTIONS

The total built-up area is drawn as a rectangle representing 100%, indicating core service (hatched horizontally), habitable room (hatched vertically when representing core, and dotted when representing the final dwelling in the shifted rectangle), and circulation.

The area of core service is larger in the Proposed Design than in the Port Said design as the latter does not

include a separate space for a kitchen. The ratio of core service area when compared to the finished dwelling is more reasonable in the former proposal.

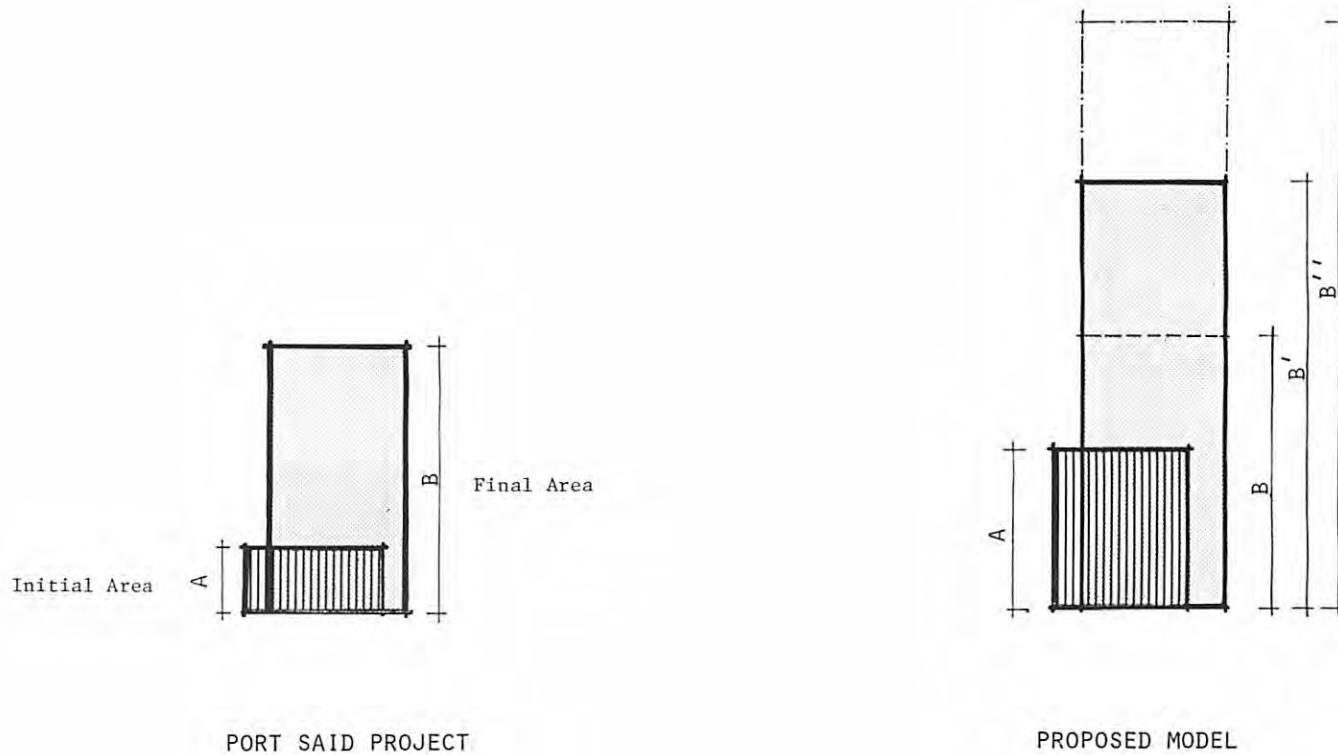
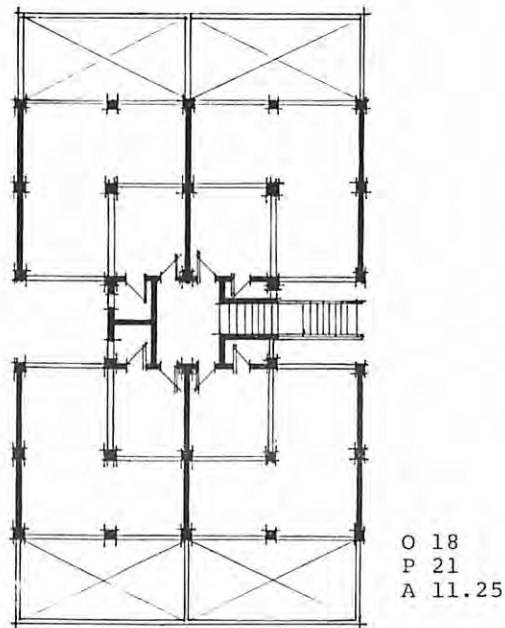

Figure 5: MAXIMUM BUILT AREA

The area of the core, in both of the two types, is drawn as a rectangle hatched vertically, having the same width for easy comparison, while the finished core is drawn in a shifted dotted rectangle. In the Proposed Model the maximum built area at completion shows three different areas. This is because flexibility is inherent in the

design concept, thus offering different possibilities of expansion.



PORT SAID PROJECT

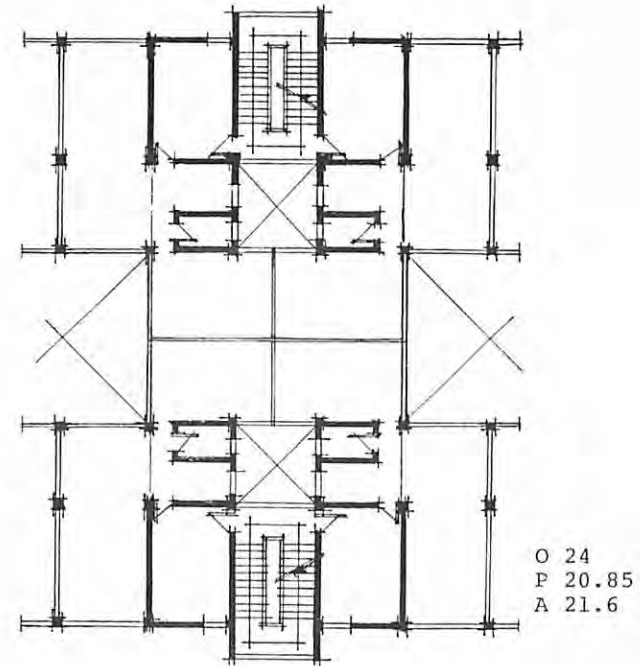

PROPOSED MODEL

Figure 6: CONSTRUCTION

The two types are drawn showing their construction. Both are of skeleton type construction. The regular grid with 3 meter spans of the Proposed Model could easily be adopted to load bearing walls, in which case the flexibility of different design alternatives for expansion would be limited. Prefabricated wall panels could also be used or even the tunnel form type of construction system.

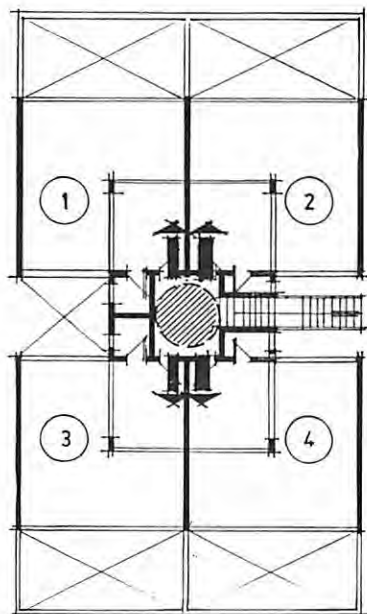

PORT SAID PROJECT

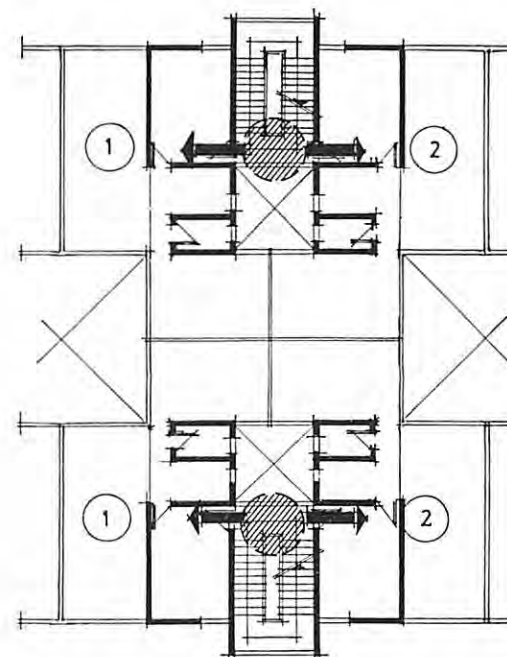

PROPOSED MODEL

Figure 7: STAIRCASE ACCESS

The plans are drawn showing the stairs with their access to the flats. In the Port Said design, the staircase gives access to 4 separate dwelling units. In the Proposed Model each staircase gives access to 2 dwelling units only, but in the first example the staircase can only reach one floor so each stair case serves only one

level or 4 individual dwellings while in the Proposed Model it can serve 3 or 4 floors.

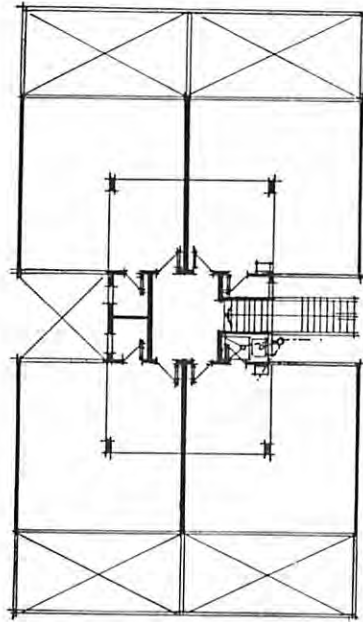

PORT SAID PROJECT

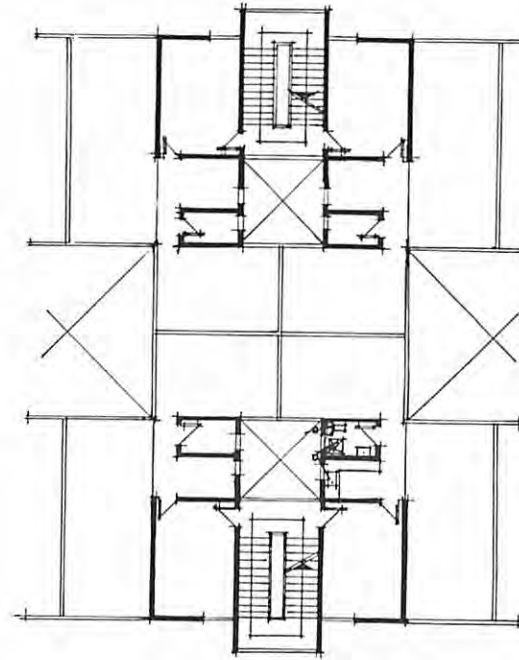

PROPOSED MODEL

Figure 8: UTILITIES

The two types are drawn showing their sanitary fixtures and plumbing within the flat and the main pipe lines for waste. The distance to the manhole in the street is essentially the same for both cases.

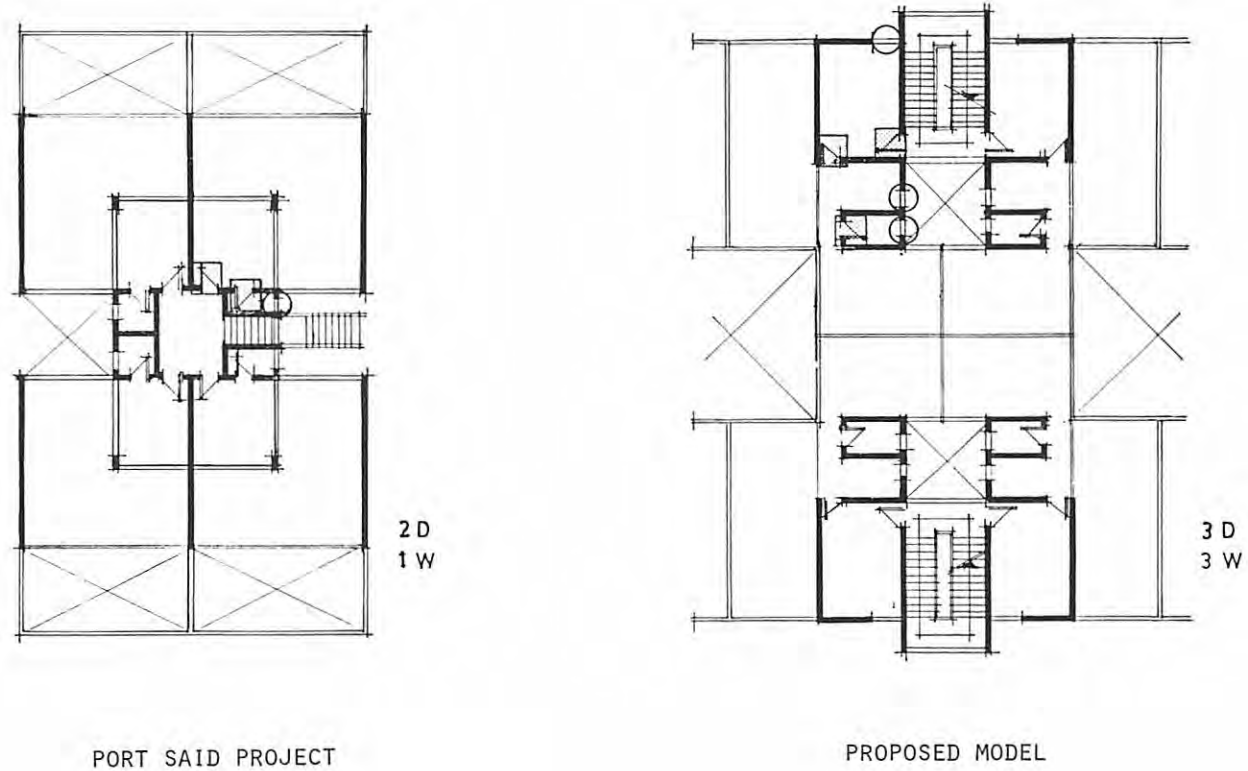

Figure 9: DOORS AND WINDOWS

The two types are drawn showing their doors by squares and the windows by circles. In the Port Said design the number of doors and windows are less than the Proposed Model as the habitable room has no walls but just a roof. Only the bath room is closed by a door and window.

APPENDIX A

Core House Units:

Sadat City New Town

Ameriyah New Town

10th of Ramadan New Town

Cabanon New Community (Suez)

Ismailia Demonstration Project

Helwan New Community (MOH-AID)

Assuit Project (MOH-World Bank)

Proposed Model

Vertical Core House Units:

Port Said Demonstration Project

Proposed Model

TYPE 1

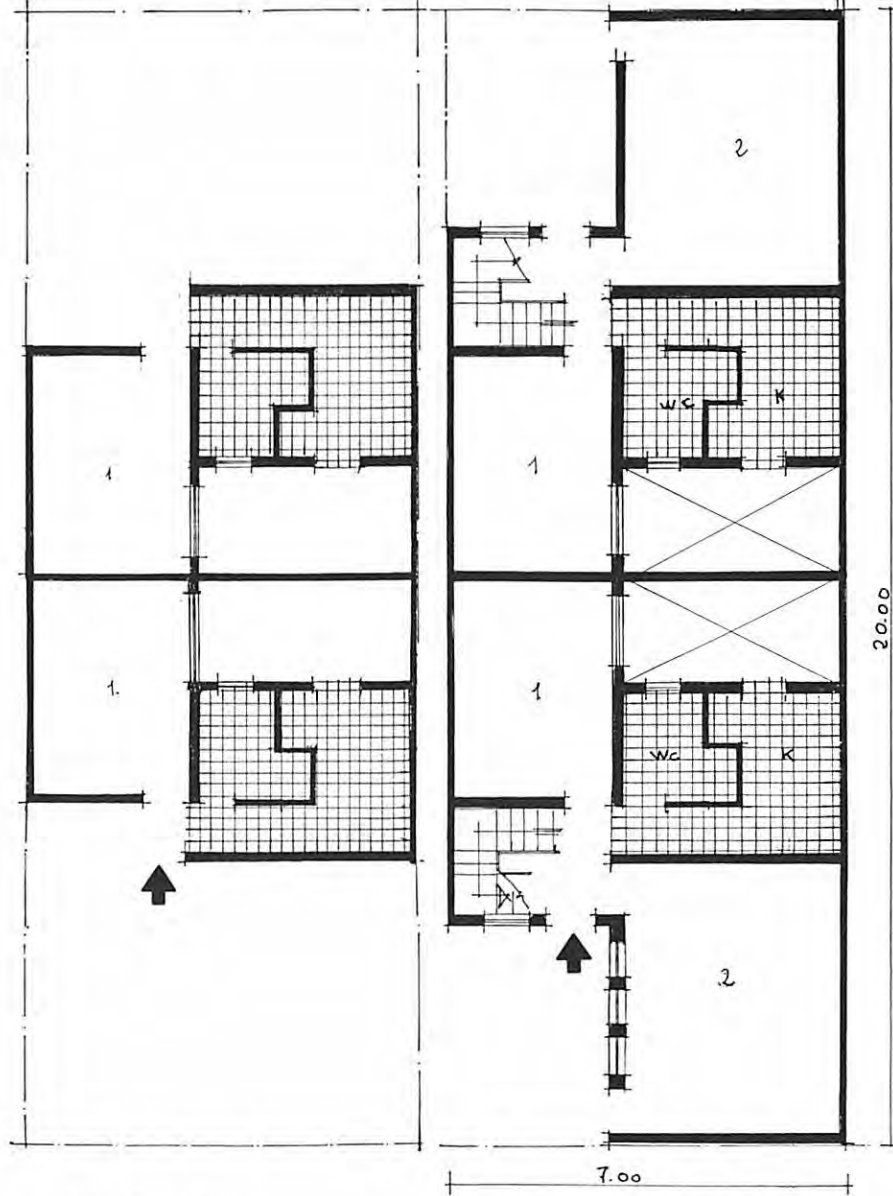

INITIAL CORE

COMPLETED UNIT-GROUND FLOOR
(anticipated by designers)

TYPE 2

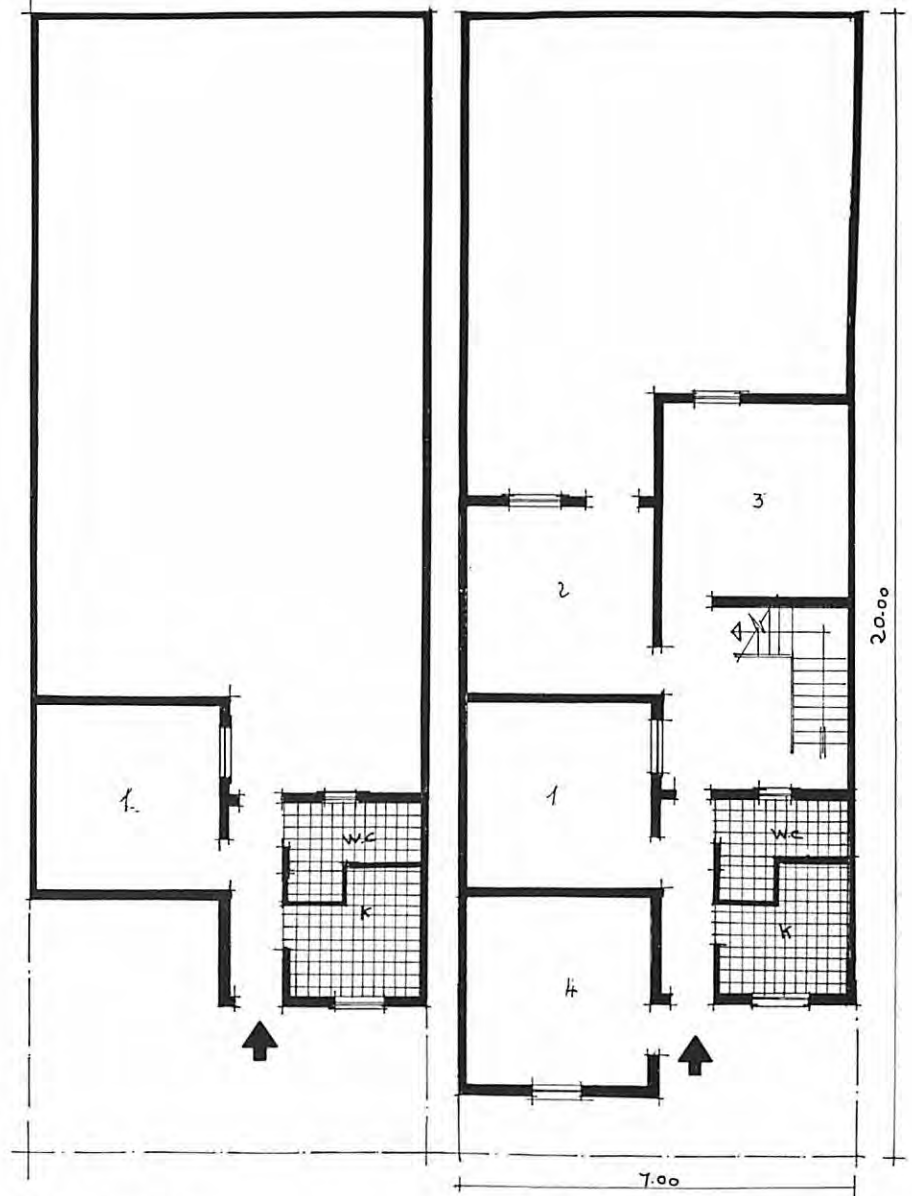

INITIAL CORE

COMPLETED UNIT-GROUND FLOOR
(anticipated by designers)

SADAT CITY NEW TOWN CORE HOUSE UNITS

Source: Working Drawings, Sadat City Development Group,
January 1979, Scale 1:50.

TYPE 1

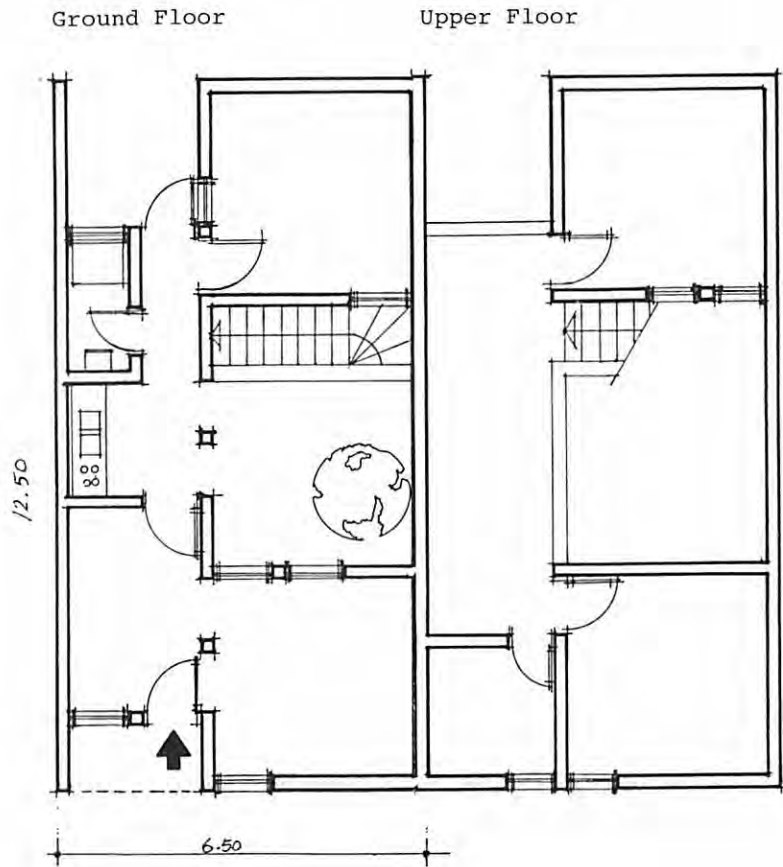

COMPLETED UNIT
(anticipated by designers)

TYPE 2

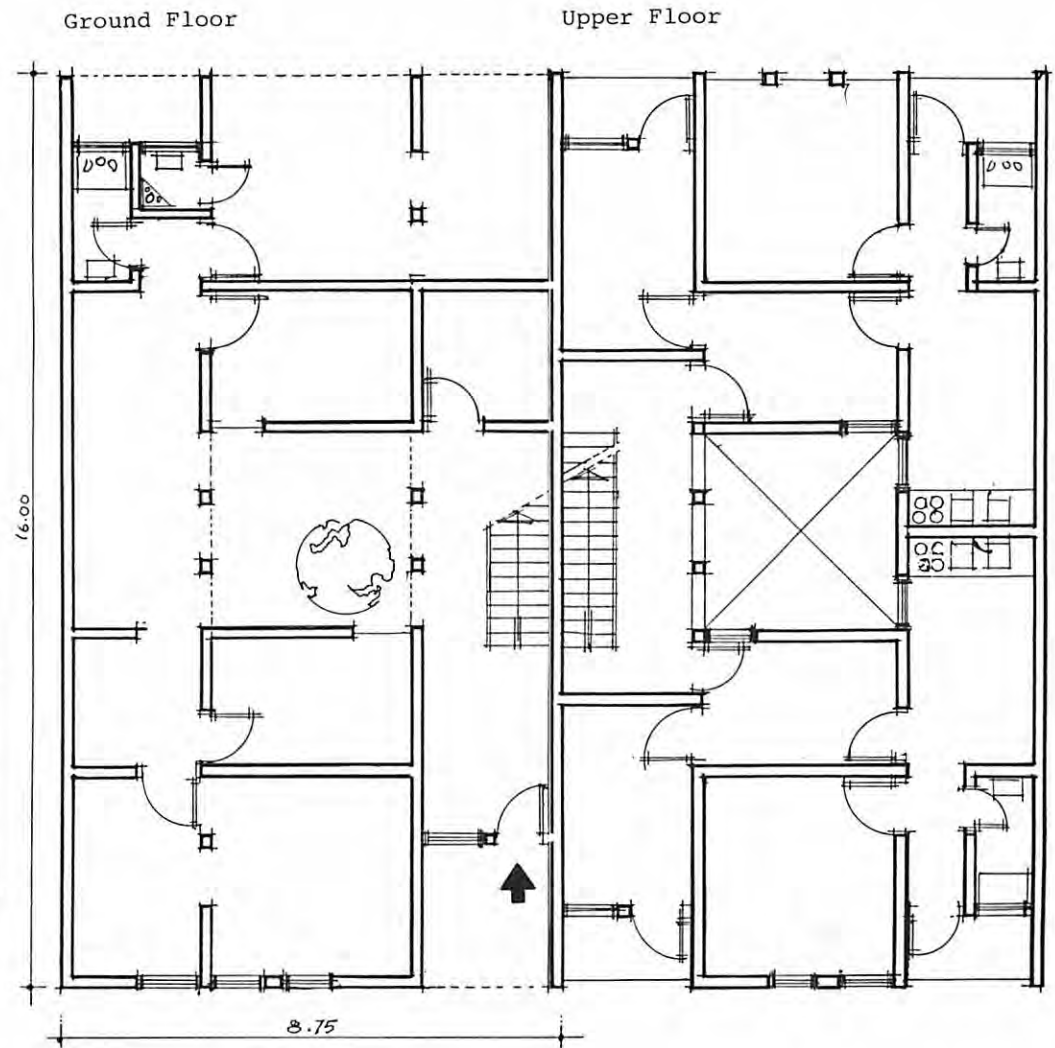

COMPLETED UNIT
(anticipated by designers)

Source: *Expandable Minimum Ameriyah Dwelling, EMAD, Pacer/ILACO, 1980 (date not indicated).*

TYPE 1

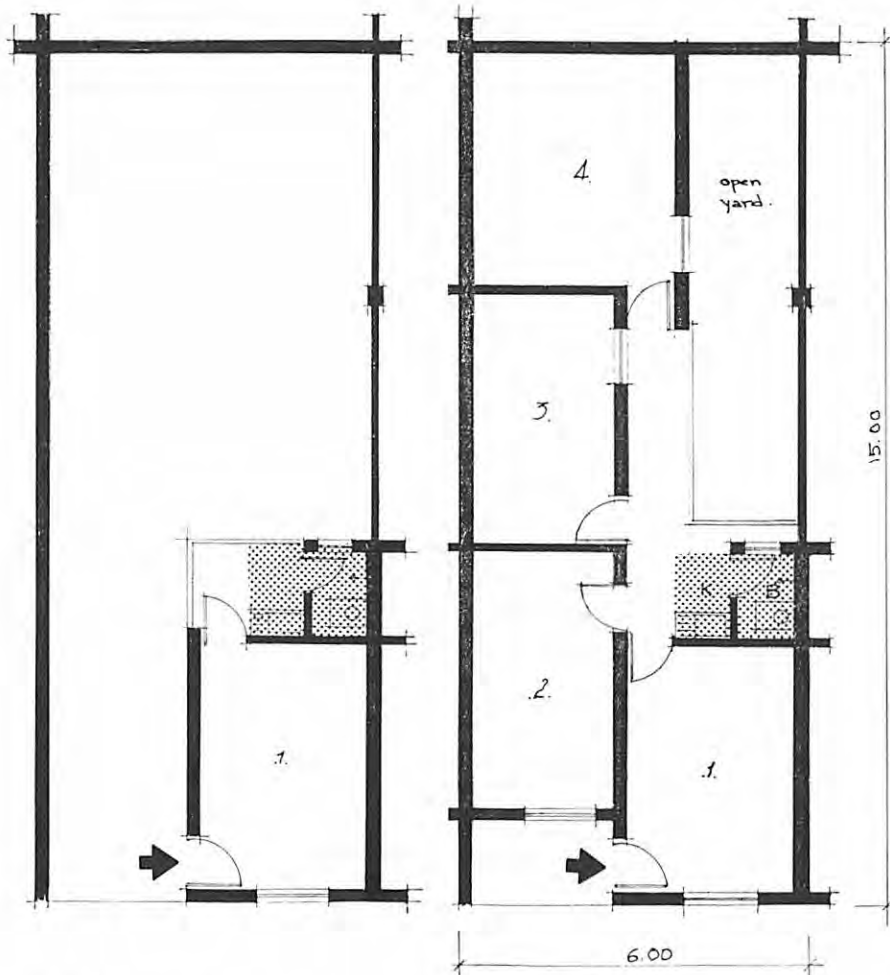

INITIAL CORE

COMPLETED UNIT
(anticipated by designers)

TYPE 2

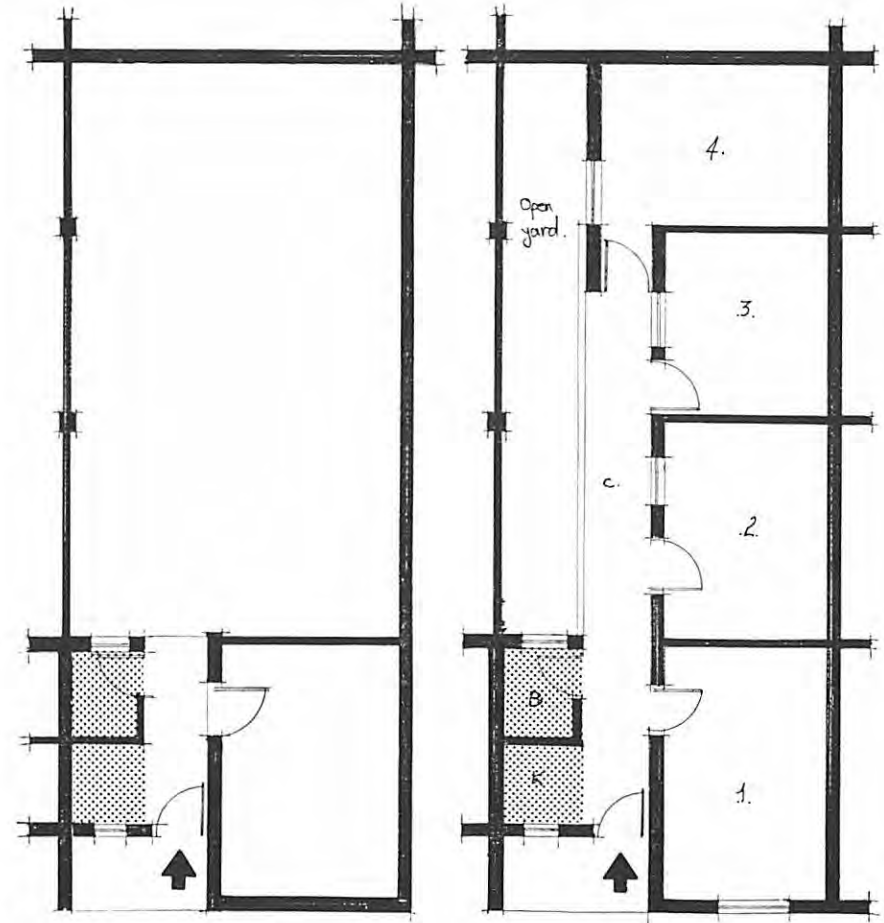

INITIAL CORE

COMPLETED UNIT
(anticipated by designers)

TYPE 1

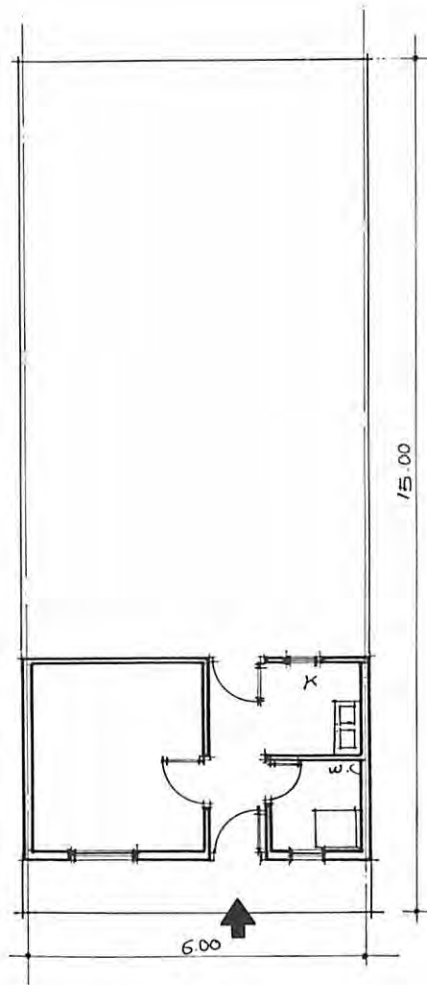

INITIAL CORE

TYPE 2

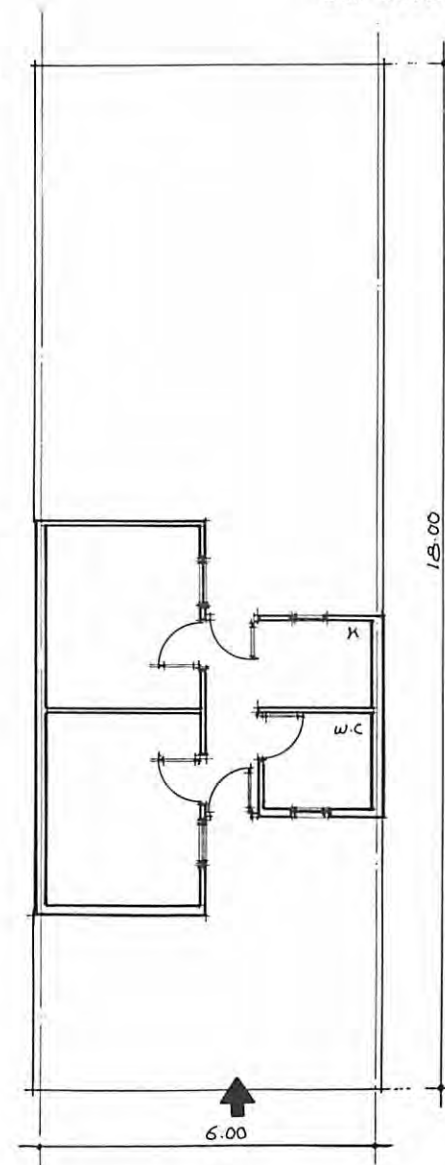

INITIAL CORE

CABANON NEW COMMUNITY CORE HOUSE UNITS
(SUEZ)

Source: Cabanon New Community, Demonstration Projects
Draft Kayat Report, Vol. 2, February 1978.

TYPE 1

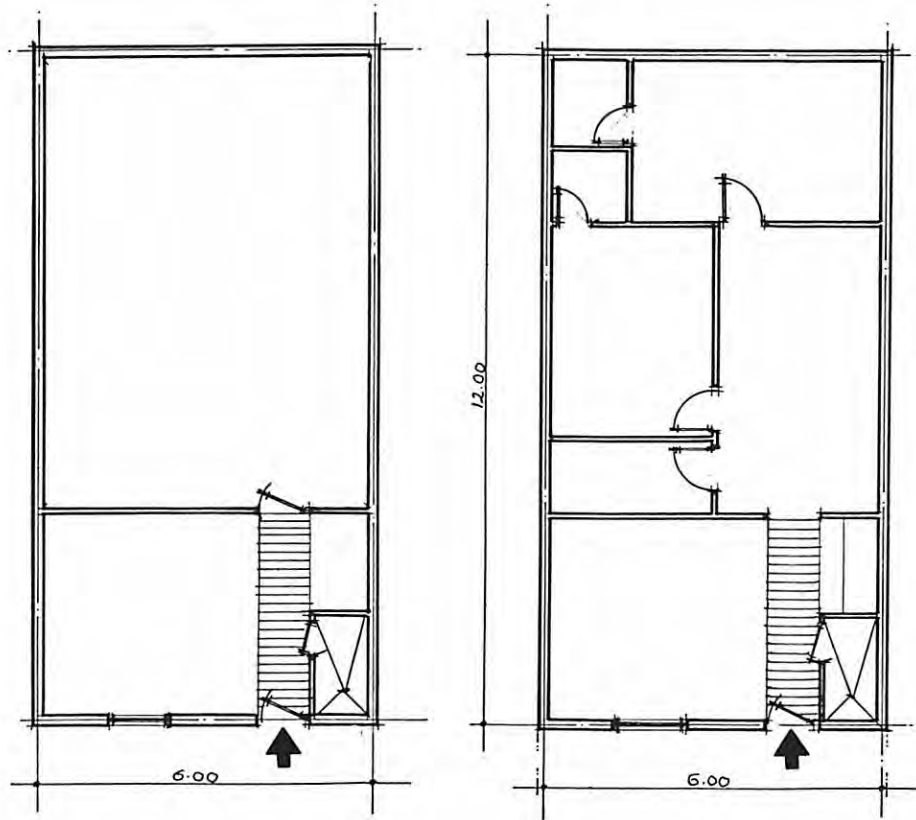

INITIAL CORE

COMPLETED UNIT
(anticipated by designers)

TYPE 2

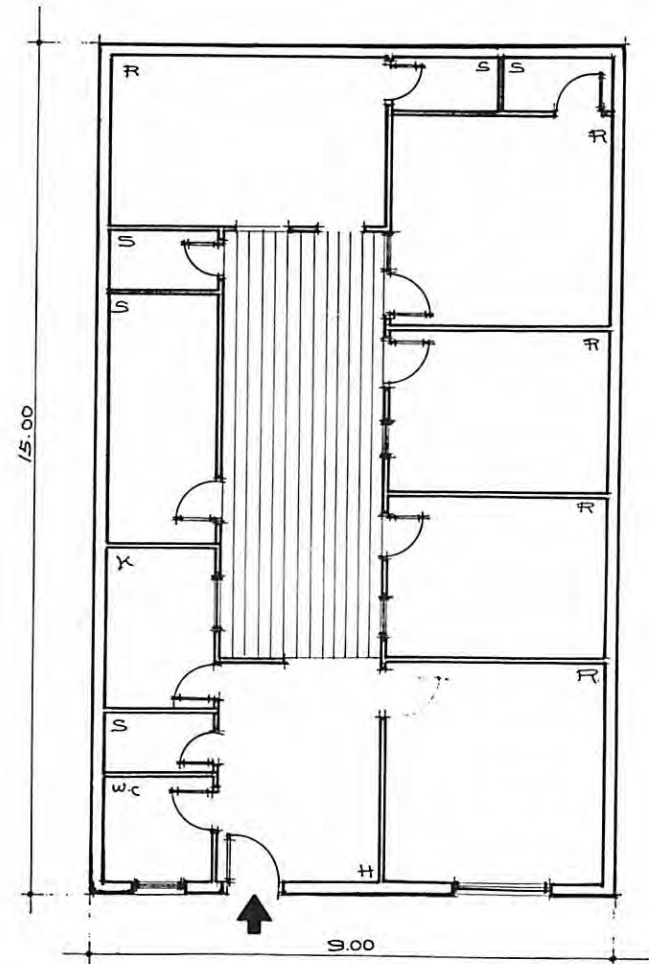

COMPLETED UNIT
(anticipated by designers)

TYPE 1

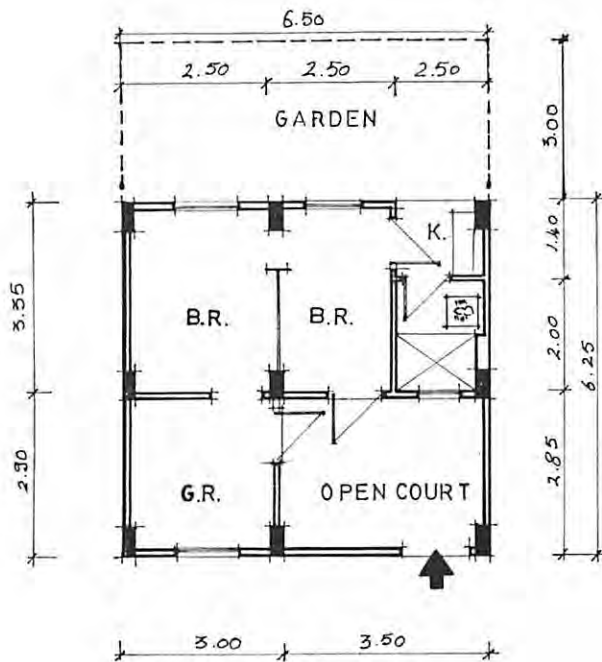

COMPLETED UNIT
(anticipated by designers)

TYPE 2

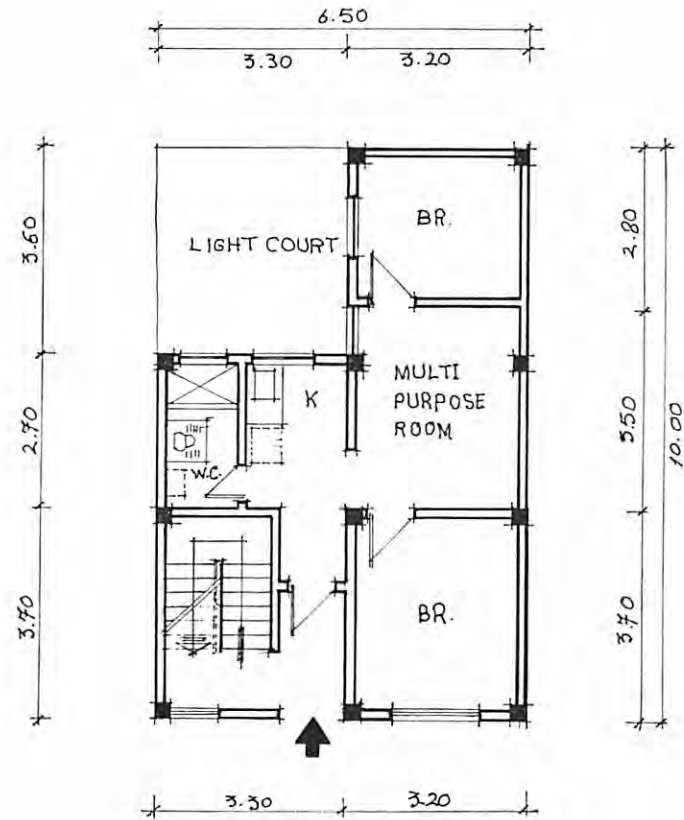

COMPLETED UNIT
(anticipated by designers)

HELWAN NEW COMMUNITY CORE HOUSE UNITS
(MOH-AID)

Source: "Final Engineering Feasibility Report", September 1978, and "Project Paper: Housing and Community Upgrading for Low Income Egyptians", July 3, 1978, Scale 1:100.

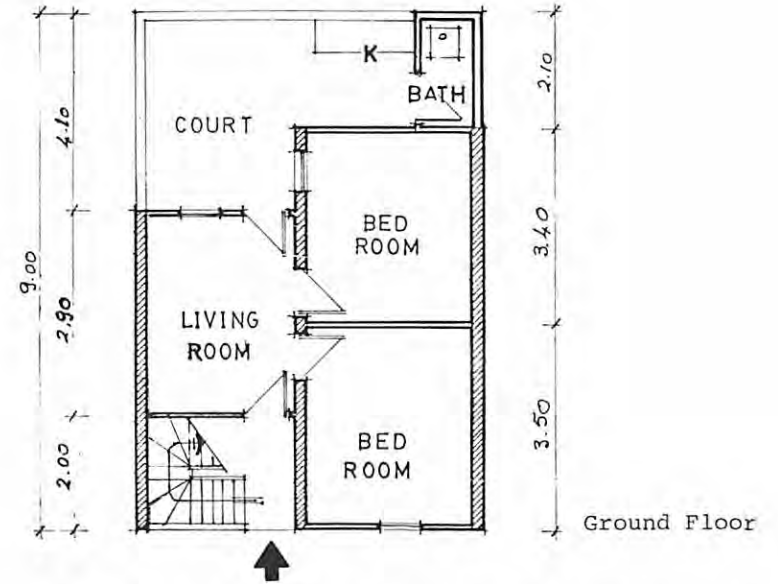
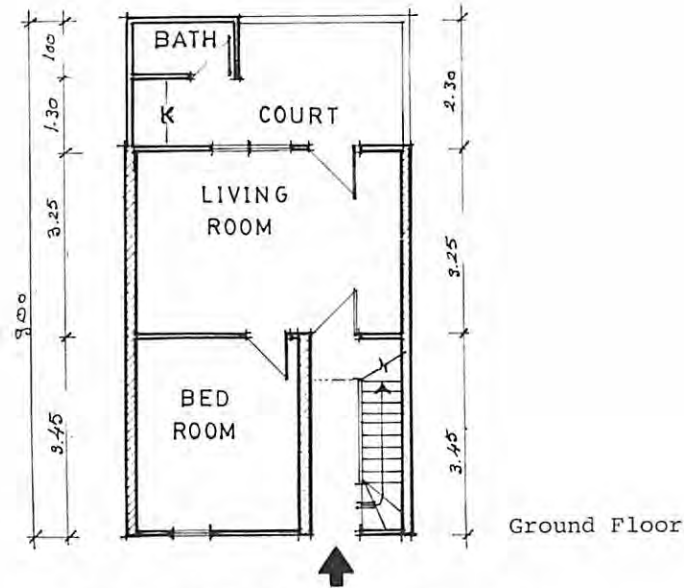
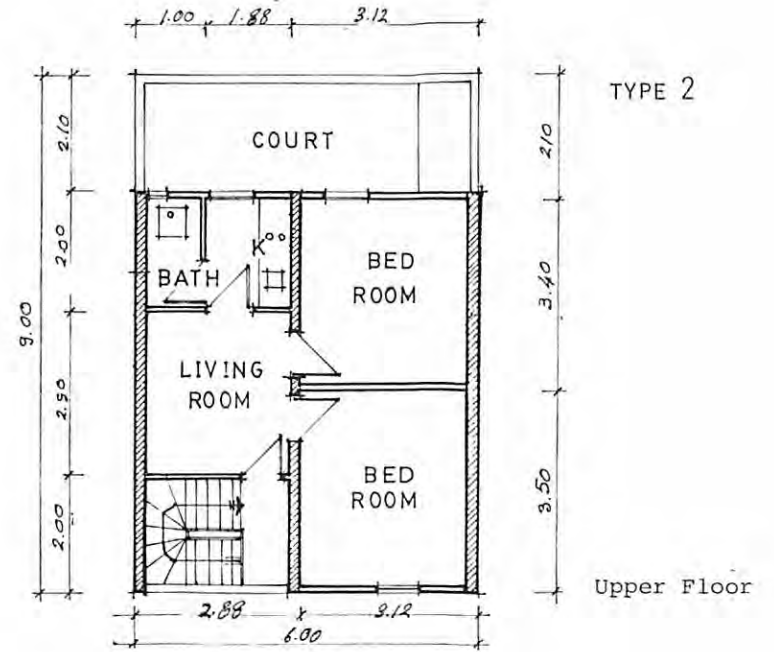
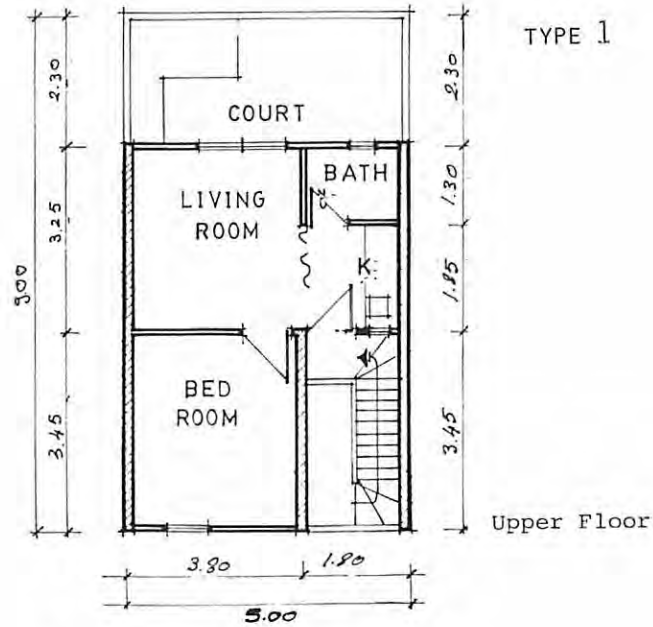

ASSUIT PROJECT CORE HOUSE UNITS
(MOH-WORLD BANK)

COMPLETED UNIT
(anticipated by designers)

Source: Preliminary Drawings, GOPP 1977, Scale 1:200 and 1:100.

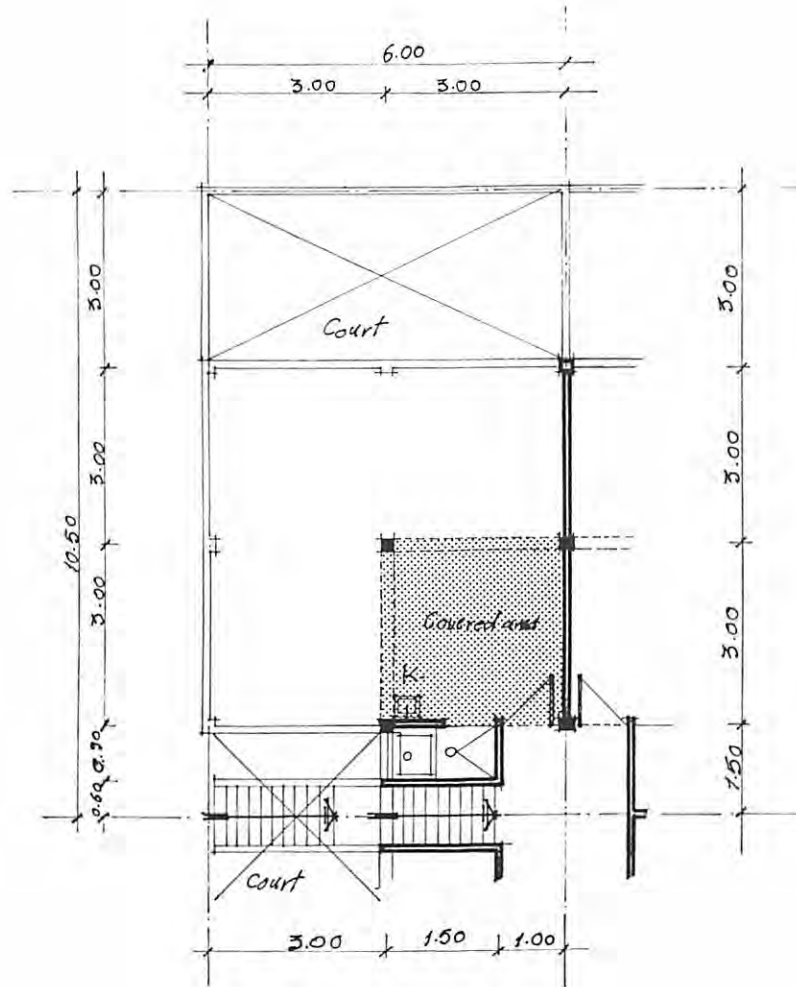

INITIAL CORE UNIT (1/4 section of floor)

TYPE 1

COMPLETED UNIT-UPPER FLOOR
(anticipated by designers)

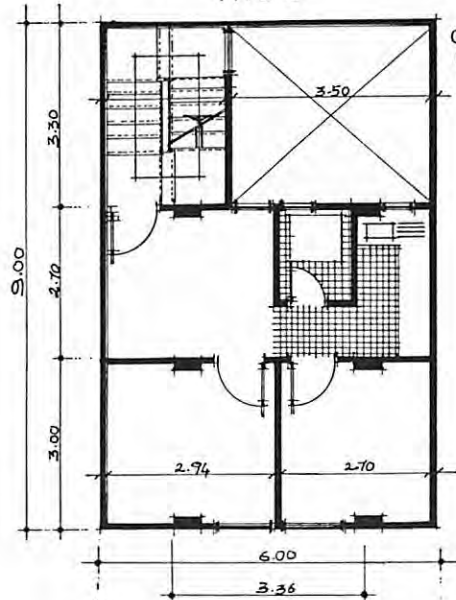

6.00
3.36

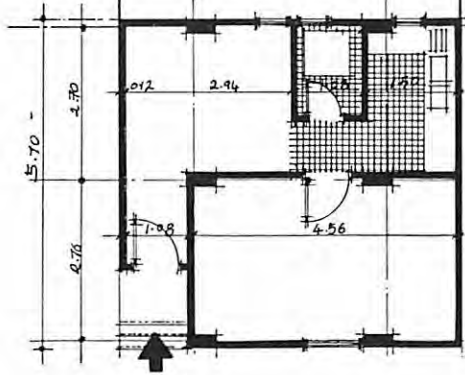

5.70
4.70
4.56
1.08

INITIAL CORE

PROPOSED MODEL CORE HOUSE UNITS

TYPE 2

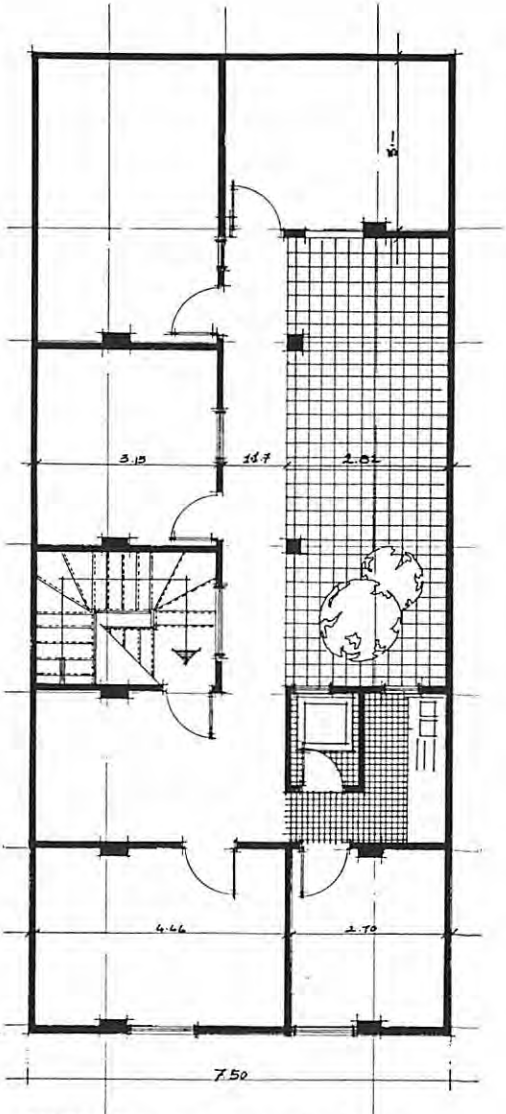

17.40
5.10
3.50
4.25
4.50
4.06

7.50
3.15
1.08
2.70

COMPLETED UNIT-UPPER FLOOR
(anticipated by designers)

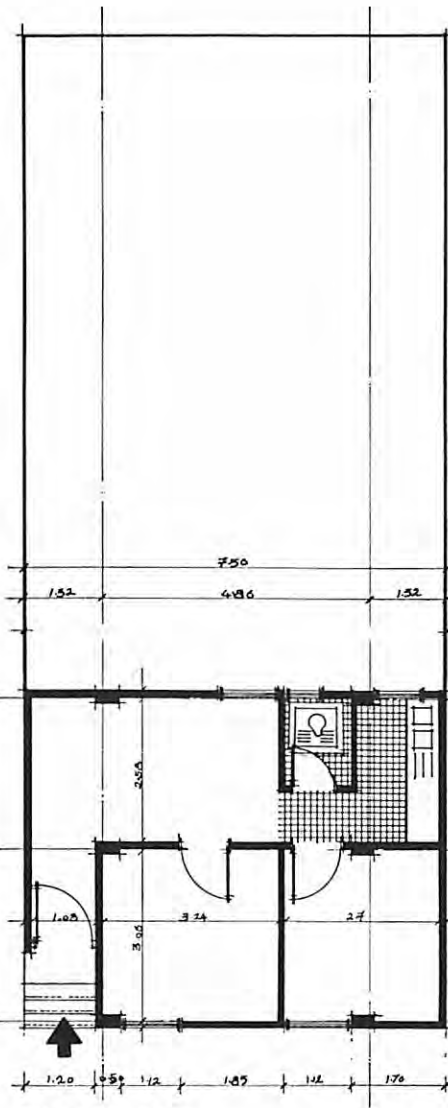

7.50
1.52
4.86
1.52
6.48
1.08
4.74
4.65
3.05
3.24
2.4
1.08

1.20
0.5
1.2
1.05
1.4
1.70

INITIAL CORE

Source: (See also "Interim Report Working Papers 1978" The Housing and Construction Industry in Egypt, TAP Report 79-5, Spring 1979)

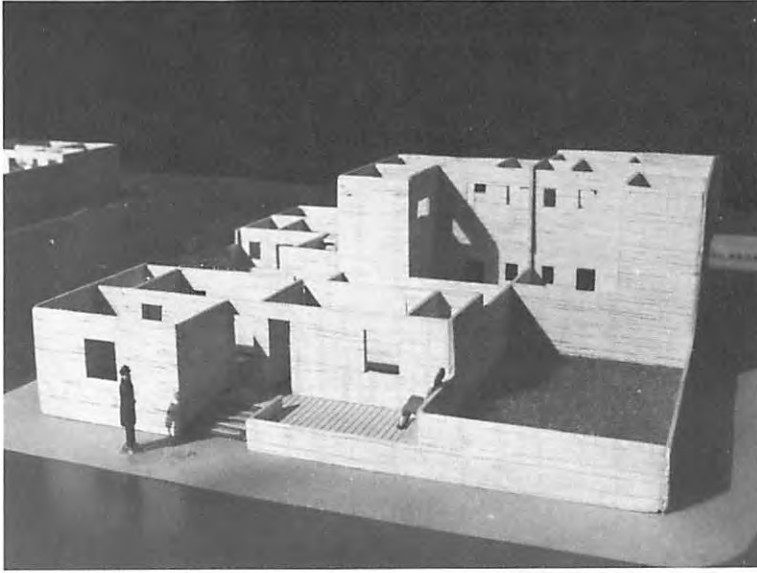

FRONT ELEVATION: GROUP OF UNITS AT VARIOUS STAGES
Proposed Model Core House Units

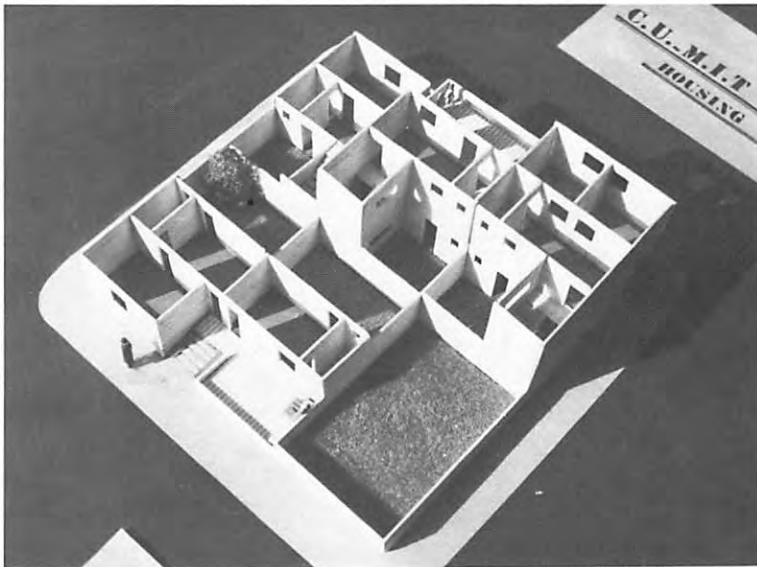

CUT-AWAY VIEW SHOWING ROOM ARRANGEMENT
Proposed Model Core House Units

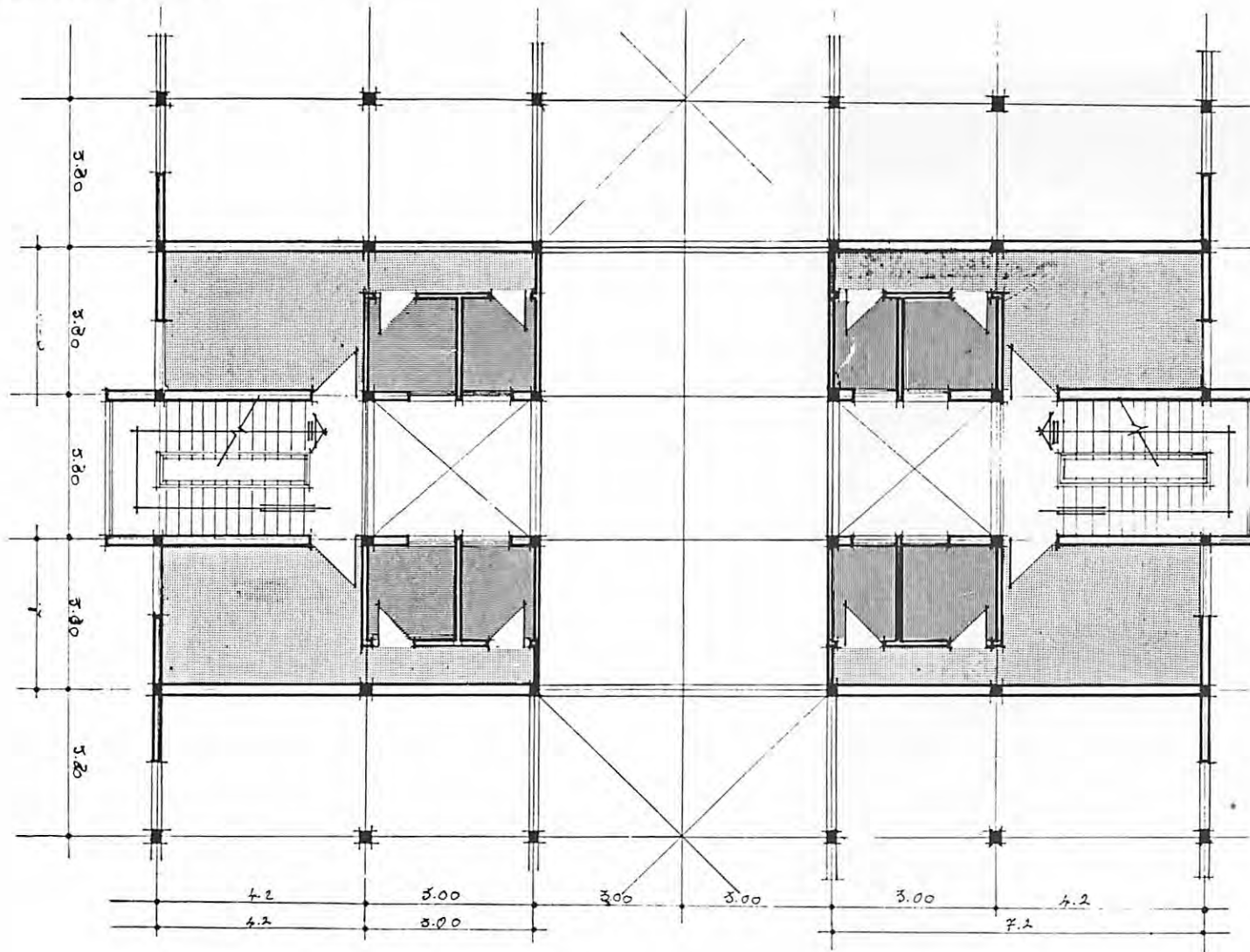

INITIAL CORE UNITS

PROPOSED MODEL VERTICAL CORE HOUSING

(For design details, see: "Support System Proposal", INTERIM REPORT WORKING PAPERS 1978, pages 31-34.)



FRONT ELEVATION
Proposed Model Vertical Core House

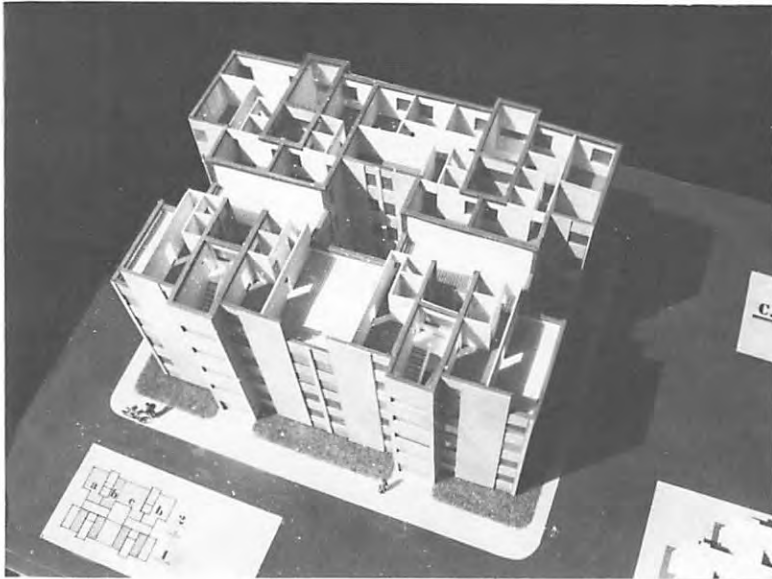

CUT-AWAY VIEW SHOWING ROOM ARRANGEMENT
Proposed Model Vertical Core House